

## PRODUCT DATA SHEET



### **PART NUMBER - BEH-100-30-22AK:** BRAH

Electric, aftermarket direct replacement contactors for ABB EH-100, type EH-100, 3P, 3PH, 120A, 600V, 40HP @ 240V, 75HP @ 480V, 100HP @ 600V, complete with 240V AC coil, 2 N/O - 2 N/C auxiliary contact, AC magnetic contactor

### **PRODUCT SPECIFICATIONS**

MAGNETIC CONTACTOR  
PART NO. BEH-100-30-22AK

<i>TYPE</i>	<i>VALUE (UNITS)</i>	<i>NOTES</i>	<i>COMMENTS</i>
<i>PHASE</i>	3		
<i>POLES</i>	3		
<i>VOLTAGE</i>	600 (VAC)		
<i>AMPERAGE</i>	120 (A)		
<i>COIL VOLTAGE MIN</i>	240 (V)		
<i>COIL VOLTAGE MAX</i>	240 (V)		
<i>MIN HP. RATING</i>	40 (HP)	@ 240V	
<i>MAX HP RATING</i>	100 (HP)	@ 600V	

#### ADDITIONAL INFORMATION:

- \* Interchangeable Coils with multiple coil voltages available; (24V, 48V, 120V, 208V, 240V, 277V, 380V, 480V, 600V)
- \* Auxiliary contacts are arranged with screw type terminals
- \* We use fine quality silver for our contacts, containing 95% silver content

**Warranty:** All Products sold by BRAH Electric are guaranteed to be free of defect for a period of one year, under the condition that the product has been installed and operated properly. All items proven defective within the one year period will be replaced by BRAH Electric. In the event that we cannot provide a direct replacement, your monies will be refunded in full. We are not responsible for any consequential losses or damages outside of the defective product as well as any replacements or repairs performed by another party without our written authorization from BRAH Electric

REVISIONS

ZONE	REV.	DESCRIPTION	DATE	APPROVED
------	------	-------------	------	----------

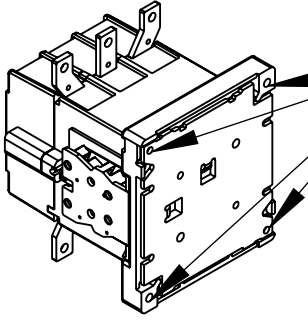

MOUNTING HOLES

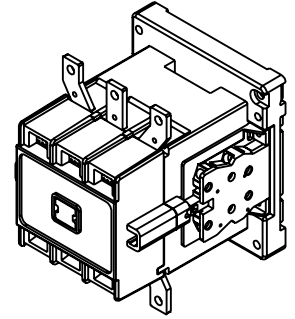

ISO VIEW

4.92  
[125.0]

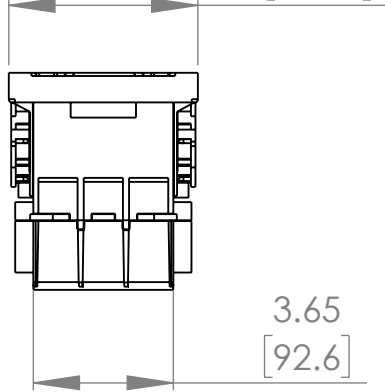

3.65  
[92.6]

6X  $\varnothing$ 0.25  
[6.4]

4X  $\varnothing$ 0.24  
[6.0]

0.31  
[8.0]

0.41  
[10.5]

5.65  
[143.5]

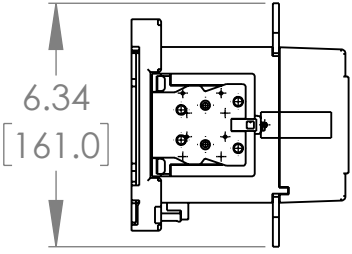

6.34  
[161.0]

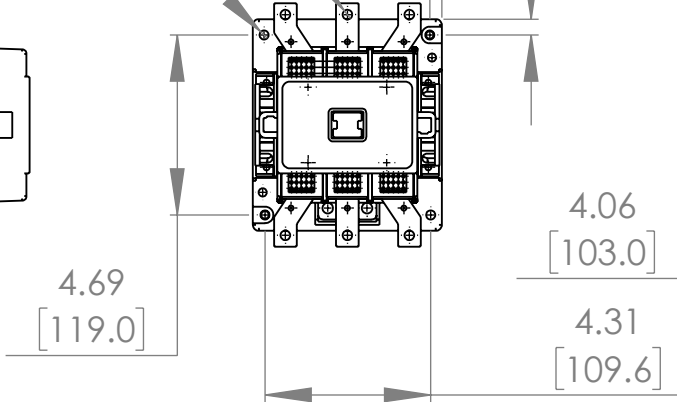

4.69  
[119.0]

4.06  
[103.0]

4.31  
[109.6]

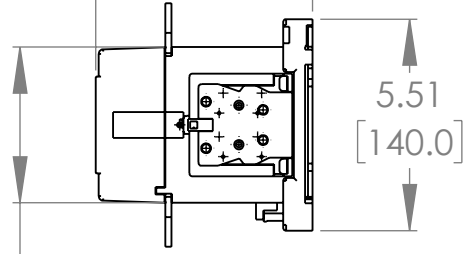

5.51  
[140.0]

\* NOTE: BRAH ELECTRIC CONTACTOR IS A DIRECT REPLACEMENT FOR ABB EH-100-30-22AK, EH SERIES. SUITABLE FOR USE WITH EH SERIES MOTOR CONTROL SYSTEMS

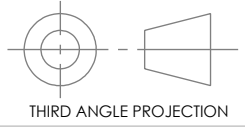

THIRD ANGLE PROJECTION

**PROPRIETARY AND CONFIDENTIAL**  
THE INFORMATION CONTAINED IN THIS DRAWING IS THE SOLE PROPERTY OF BRAH ELECTRIC. ANY REPRODUCTION IN PART OR AS A WHOLE WITHOUT THE WRITTEN PERMISSION OF BRAH ELECTRIC IS PROHIBITED.

UNLESS OTHERWISE NOTED  
ALL DIMENSIONS ARE IN INCHES  
METRIC UNITS ARE DISPLAYED  
BENEATH IN [ MM. ]

MATERIAL	MOLDED PLASTIC CASE
FINISH	N/A
DO NOT SCALE DRAWING	



MAGNETIC CONTACTOR

SIZE	DWG. NO.	REV.
<b>A</b>	BEH-100-30-22AK	<b>A</b>
SCALE: 1:5	WEIGHT:	SHEET 1 OF 1