



VESTIL MANUFACTURING CORP.

2999 North Wayne Street, P.O. Box 507, Angola, IN 46703

Telephone: (260) 665-7586 -or- Toll Free (800) 348-0868

Fax: (260) 665-1339

www.vestilmfg.com e-mail: sales@vestil.com

FLAD SERIES FOLDING LADDERS WITH WHEELS

INSTRUCTION MANUAL



Receiving instructions:

After delivery, IMMEDIATELY remove the packaging from the product in a manner that preserves the packaging and maintains the orientation of the product in the packaging; then inspect the product closely to determine whether it sustained damage during transport. **If damage is discovered during the inspection, immediately record a complete description of the damage on the bill of lading.** If the product is undamaged, discard the packaging.

NOTES:

1) Compliance with laws, regulations, codes, and non-voluntary standards enforced in the location where the product is *used* is exclusively the responsibility of the owner/end-user.

2) VESTIL is **not liable** for any injury or property damage that occurs as a consequence of failing to apply either:
a) Instructions in this manual; or b) Information provided on labels affixed to the product. Neither is Vestil responsible for *any* consequential damages sustained as a result of failing to exercise sound judgment while assembling, installing, using or maintaining this product.





Table of Contents

Hazard identification: explanation of signal words.....	2
Safety Guidelines.....	2-3
FIG.1: Fully assembled FLAD.....	3
FIG.2: Folded FLAD.....	3
Product Specification & Storage instructions.....	4
FIG.3: Exploded Parts Drawing and Parts List.....	5
Label placement diagram.....	6
Limited warranty.....	7

Hazard Identification--Explanation of SIGNAL WORDS

This manual uses SIGNAL WORDS to indicate the likelihood of personal injuries, as well as the probable seriousness of those injuries, if the product is misused in the ways described. Other signal words call attention to uses of the product likely cause property damage.



The signal words used appear below along with the meaning of each word:

	Identifies a hazardous situation which, if not avoided, <u>WILL</u> result in DEATH or SERIOUS INJURY. Use of this signal word is limited to the most extreme situations.
	Identifies a hazardous situation which, if not avoided, COULD result in DEATH or SERIOUS INJURY.
	Indicates a hazardous situation which, if not avoided, COULD result in MINOR or MODERATE injury.
	Identifies practices likely to result in product/property damage, such as operation that might damage the product.

Each person who assembles, installs, uses, or maintains this product should read the entire manual **in advance and fully understand the directions. If after reading the manual you do not understand an instruction, ask your supervisor or employer for clarification, because failure to adhere to the directions in this manual might result in serious personal injury.**

SAFETY GUIDELINES

Vestil diligently strives to identify foreseeable hazards associated with the use of its products. However, no manual can address every conceivable risk. The end-user ultimately is responsible for exercising sound judgment at all times.

	Electrocution might result if any part of the mezzanine ladder contacts electrified wires. Reduce the likelihood of electrocution by applying common sense : <ul style="list-style-type: none"> ➤ DO NOT install the stairs where it will <i>contact</i> electrified wires is likely; ➤ DO NOT install the stairs in a location where users will contact overhead electrical wires.
	If this product is used improperly or carelessly, the operator and/or bystanders might sustain serious personal injuries or even be killed. ALWAYS use the product properly: <ul style="list-style-type: none"> • <i>Failure to read and understand the entire manual before assembling, installing, using or servicing the product constitutes misuse.</i> Read the manual to refresh your understanding of proper use and maintenance procedures. <ul style="list-style-type: none"> • DO NOT exceed the maximum rated load. • Inspect the stairs at least once every 3 months. DO NOT use these stairs if the inspection reveals structural damage. Examples of structural damage include: 1) broken, missing, or deformed risers (steps); 2) damaged or deformed stair rails or siderails; 3) cracked welds; 4) damaged fasteners (particularly those used to fasten the top of the stairs to the structure or wall above) enlarged openings for fasteners, pins, etc.; 5) corrosion, extreme wear, or other condition that affects the ability of the product to support applied weight or itself; 6) damaged, deformed or cracked ratchet jack. Immediately tag out the stairs and replace each part that fails to pass inspection. DO NOT use the product until it is fully restored to normal condition. ONLY use manufacturer-approved replacement parts. <ul style="list-style-type: none"> • DO NOT use the stairs if any unusual noise or movement is observed while weight is applied to it. If a malfunction occurs, remove the unit from service and notify your supervisor or maintenance personnel about the issue. <ul style="list-style-type: none"> • DO NOT use the stairs UNLESS it is securely fastened to the structure of the floor above. • DO NOT use the stairs as a storage rack. • DO NOT remove or obscure any label. All product labels must be readable and undamaged. • DO NOT modify the stairs in any way. Unauthorized modifications automatically void the limited warranty (see p. 10) and might make the table unsafe to use.

NOTICE Proper installation, use, and maintenance are essential for this product to function properly.

- Always use this product in accordance with the instructions in this manual.
- Keep the stairs clean & dry.
- Periodically lubricate pivot points.

FIG. 1: Fully assembled



Pull spring loaded detent pin to fold the FLAD

FIG. 2: Folded Down



Product Specifications :

Dimensions and other relevant specifications for each FLAD series folding ladder with wheels appear in the table below.

Model	Number of steps	Top Step height	Capacity	Net Weight
FLAD-2	20"	20 in.	350 lb.	311 lb.
FLAD-3	30"	30 in.	350 lb.	399b.
FLAD-4	40"	40 in.	350 lb.	47 lb.

Storage:

To store the FLAD, pull the spring loaded detent pin to fold down the FLAD and then lockk the detent pin.



Pull detent pin to fold down the ladder

FIG. 3: FLAD-4 exploded parts diagram and bill of materials

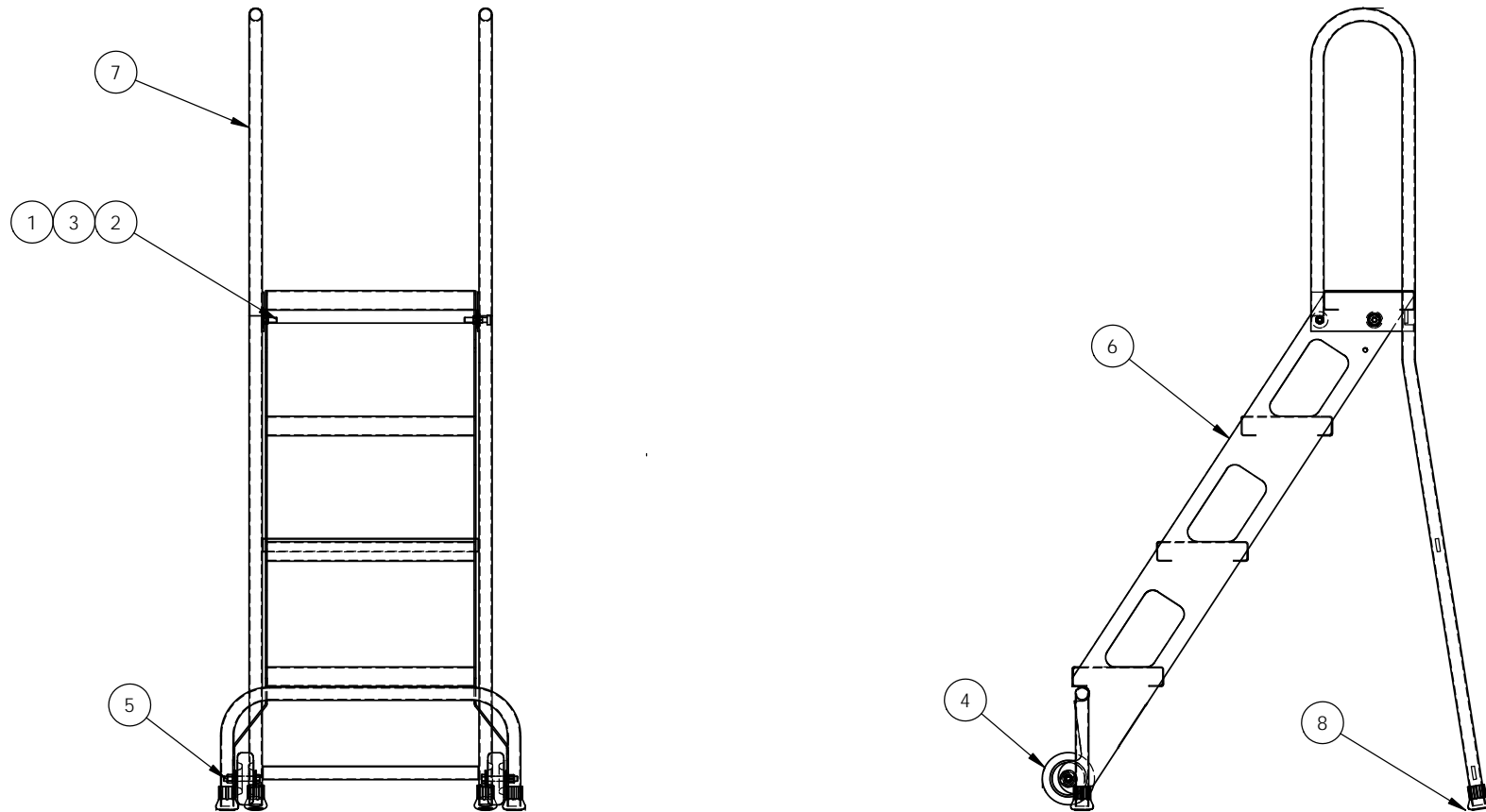

8	44-001-352-K	RUBBER STOP CRUTCH TIP	4
7	44-001-354-D	WELDMENT, HANDLE SUB-ASS'Y	1
6	44-001-354-A	WELDMENT, STEP SUB-ASS'Y	1
5	11113	HHCS #2 Z PLATED, Ø3/8 - 16 x 2 1/2 LG	2
4	16-132-009	PP-4/1.25-W	2
3	37024	3/8 NYLOCK INSERT NUT	4
2	11103	HHCS #2 ZINC PLATED, Ø 3/8 - 16 UNC X 3/4 LG.	2
1	33009	Ø7/16 USS FLAT WASHER	6
ITEM NO.	PART NUMBER	DESCRIPTION	QTY.

Label Placement Diagramm

CAUTION
TIPPING HAZARD
 CENTER BODY
 BETWEEN SIDERAILS.
 DO NOT OVER-REACH
 IN ANY DIRECTION.



731
 rev 0810

SET ALL FOUR FEET
 OF LADDER ON
 FIRM LEVEL SURFACE.

MODEL/MODÉLO/MODÈLE _____
 CAPACITY _____ lbs.
 CAPACIDAD/CAPACITÉ _____ kgs.
 SERIAL/SERIE/SÉRIE _____

VESTIL MANUFACTURING CORPORATION
 sales@vestil.com • www.vestil.com

REV 0805

SAFETY FIRST

INSPECTION

1. Inspect ladder after receipt and before each use, never climb a damaged, bent or broken step stool.
2. All parts must be in good working condition. Make sure all rivets, joints, nuts and bolts are tight, loose, spraddles, and brackets are secure, spreaders, function properly.
3. Keep unit clean and free of slippery or destructive substances.
4. DO NOT modify or alter the step stool in any way.
5. DO NOT make temporary repairs of damaged or missing parts.
6. Destroy step stool if broken or excessively worn or if exposed to fire or chemical corrosion.

PROPER SETUP

1. Fully open step stool and lock spreaders.
2. Use only on firm, even, level surfaces.

PROPER CLIMBING & USE

1. DO NOT leave step stool set up and unattended. Face step stool when climbing up or down. Center body between side rails.
2. DO NOT overreach or pull/push items over side of step stool. Position stool close to work location. Reposition as needed.
3. DO NOT move step stool when standing on it.
4. DO NOT overload. Step stool is made for one person. MAX. RATED LOAD = 250 lbs. (114 Kg)
5. DO NOT use as a crane, platform or jack.

PROPER CARE & STORAGE

1. Store step stool in safe, dry place.
2. DO NOT store materials on step stool.
3. Keep step stool clean and free of all foreign matter.

731 Rev 0810



SAFETY FIRST SEGURIDAD PRIMERO
 Read owners manual and all labels before using. Lea el manual del propietario y todos los etiquetas antes del uso.

LIMITED WARRANTY

Vestil Manufacturing Corporation ("Vestil") warrants this product to be free of defects in material and workmanship during the warranty period. *Our warranty obligation is to provide a replacement for a defective original part if the part is covered by the warranty, after we receive a proper request from the warrantee (you) for warranty service.*

Who may request service?

Only a warrantee may request service. *You are a warrantee if* you purchased the product from Vestil or from an authorized distributor AND Vestil has been fully paid.

What is an "original part"?

An original part is a part used to make the product as shipped to the warrantee.

What is a "proper request"?

A request for warranty service is proper if Vestil receives: 1) a photocopy of the Customer Invoice that displays the shipping date; AND 2) a written request for warranty service including your name and phone number. Send requests by any of the following methods:

<u>Mail</u>	<u>Fax</u>	<u>Email</u>
Vestil Manufacturing Corporation 2999 North Wayne Street, PO Box 507 Angola, IN 46703	(260) 665-1339 <u>Phone</u> (260) 665-7586	sales@vestil.com

In the written request, list the parts believed to be defective and include the address where replacements should be delivered.

What is covered under the warranty?

After Vestil receives your request for warranty service, an authorized representative will contact you to determine whether your claim is covered by the warranty. Before providing warranty service, Vestil may require you to send the entire product, or just the defective part or parts, to its facility in Angola, IN. The warranty covers defects in the following original dynamic components: motors, hydraulic pumps, electronic controllers, switches and cylinders. It also covers defects in original parts that wear under normal usage conditions ("wearing parts"), such as bearings, hoses, wheels, seals, brushes, and batteries.

How long is the warranty period?

The warranty period for original components is 30 days. The warranty period begins on the date when Vestil ships the product to the warrantee. If the product was purchased from an authorized distributor, the period begins when the distributor ships the product. Vestil may extend the warranty period for products shipped from authorized distributors by *up to* 30 days to account for shipping time.

If a defective part is covered by the warranty, what will Vestil do to correct the problem?

Vestil will provide an appropriate replacement for any covered part. An authorized representative of Vestil will contact you to discuss your claim.

What is not covered by the warranty?

1. Labor;
2. Freight;
3. Occurrence of any of the following, which automatically voids the warranty:
 - Product misuse;
 - Negligent operation or repair;
 - Corrosion or use in corrosive conditions;
 - Inadequate or improper maintenance;
 - Damage sustained during shipping;
 - Accidents involving the product;
 - Unauthorized modifications: DO NOT modify the product IN ANY WAY without first receiving written authorization from Vestil. Modification(s) might make the product unsafe to use or might cause excessive and/or abnormal wear.

Do any other warranties apply to the product?

Vestil Manufacturing Corp. makes no other express warranties. All implied warranties are disclaimed to the extent allowed by law. Any implied warranty not disclaimed is limited in scope to the terms of this Limited Warranty.

