

DENBIG

DEHUMIDIFIER

Instruction Manual

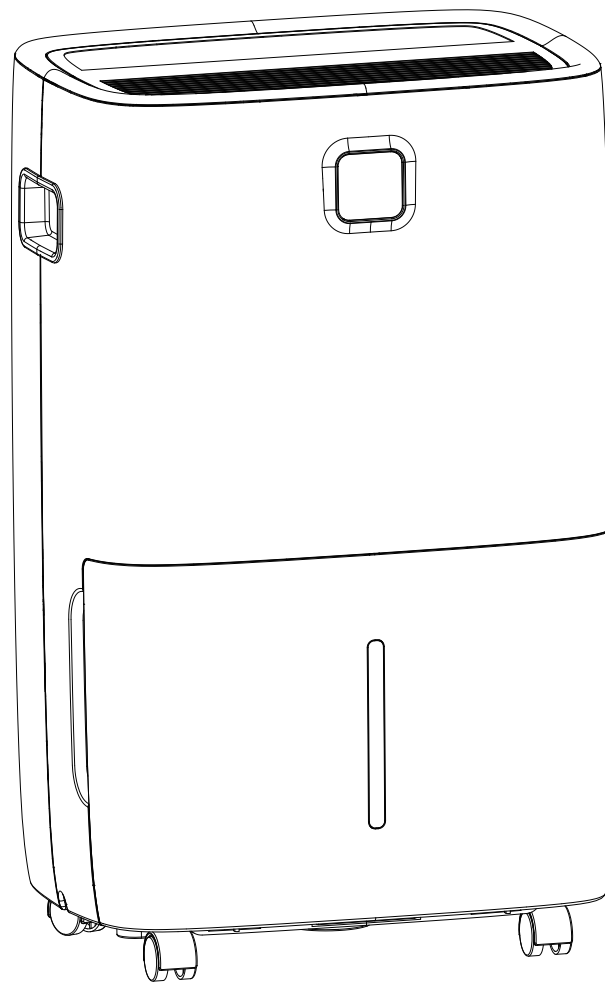

Model: D025P-35Pt3/D026P-50Pt3-P

Before using this product, please read this manual carefully and keep it for future reference.

Contents

| | |
|----------------------------|-----|
| 1. Safety Precautions..... | 1-2 |
| 2. Introduction..... | 3-5 |
| 3. Water Removal..... | 5-7 |
| 4. Maintenance..... | 8 |
| 5. Troubleshooting..... | 9 |
| 6. Customer Service..... | 10 |

Safety Precautions

When using the dehumidifier, please read the following safety instructions:

- Make sure hands are dry when connecting the power plug.
- Ensure the three-prong grounded power plug is securely inserted into a properly grounded wall socket.
- Always inspect the cord for signs of damage before use. If the power cord is damaged, it must be replaced by the manufacturer or a qualified service technician.
- Do not use an adapter plug or extension cord.
- Do not disassemble or modify the unit.
- Do not start or stop the unit by inserting or pulling out the power plug.
- Unplug the unit if strange sounds, smell, or smoke comes from it.
- If the unit is damaged or malfunctions, immediately cease operation, unplug it from the electrical outlet. Refer to the Troubleshooting section, and contact the customer support for assistance.
- Do not use the unit in the immediate surroundings of a bath, a shower, swimming pool, or clothes dryer.

- Never use or store gasoline or other flammable vapor or liquid near this unit.
- Do not use outdoors. The unit is intended for indoor use only.
- Do not climb up on or sit on the unit.
- The unit is not designed to be used by children or people with reduced physical, sensory or mental capabilities without supervision.
- Children should be supervised to ensure that they do not play with the unit.
- Always place the unit on a level surface strong enough to support the unit with a full bucket of water.
- Maintain at least 12-18 inches clearance space around this unit.
- Do not insert anything into the air outlet.
- Do not cover the unit's air inlet or outlet to prevent potential unit failure.
- Do not place flower vases or other water containers on top of the unit. Water may spill inside the unit, causing insulation failure and electrical shock or fire.
- To reduce the risk of fire or electric shock, do not use this dehumidifier with any solid-state speed control device.
- Place the dehumidifier in an area where the temperature will not fall below 41°F.
- Always unplug the unit before emptying the water bucket.
- Do not take the water bucket out during operation.
- The coils can become covered with frost if the room temperature is too low, which may reduce performance.

| | |
|--|--|
|  <p>Caution, risk of fire Avertissement: risqued'incendie/ matériaux inflammables</p> | <p>WARNING</p> <ul style="list-style-type: none"> • Do not use means to accelerate the defrosting process or to clean, other than those recommended by the manufacturer. • The appliance shall be stored in a room without continuously operating ignition sources (for example. open flames, an operating gas appliance or an operating electric heater) • Do not pierce or burn. • Be aware that refrigerants may not contain an odour. |
| | <p>AVERTISSEMENT</p> <ul style="list-style-type: none"> • Ne pas utiliser de produits permettant d'accélérer le dégel ou de produits de nettoyage autres que ceux recommandés par le fabricant. • L'appareil doit etre entrepose dans un endroit sans source dallumage fonctionnant en continu (par exemple: flamme nue, appareil au gaz en marche ou radiateur électrique en marche) • Ne pas percer ni brûler. • Attention: les frigorigenes peuvent etre inodores. |

Introduction

PRODUCT OVERVIEW

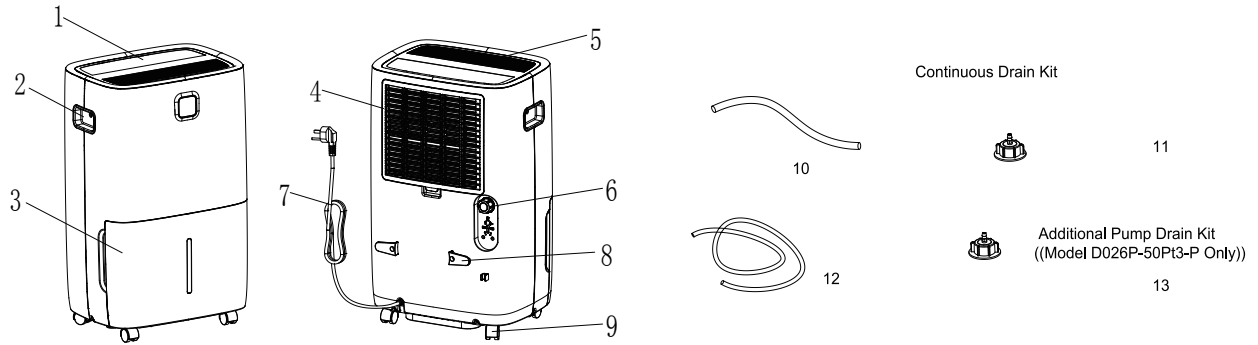

| | | |
|------------------|----------------------|----------------------------|
| 1. Control Panel | 2. Handle | 3. Water Collection Bucket |
| 4. Filter | 5. Air Outlet | 6. Drain Outlet |
| 7. Power Cord | 8. Power Cord Buckle | 9. Caster |

| Continuous Drain Kit | |
|---|-------------------|
| 10. 1.9 ft Long Drain Hose | 11. Drain Adapter |
| Pump Drain Kit (Model D026P-50Pt3-P Only) | |
| 12. 5.9 ft Long Pump Drain Hose | 13. Pump Adapter |

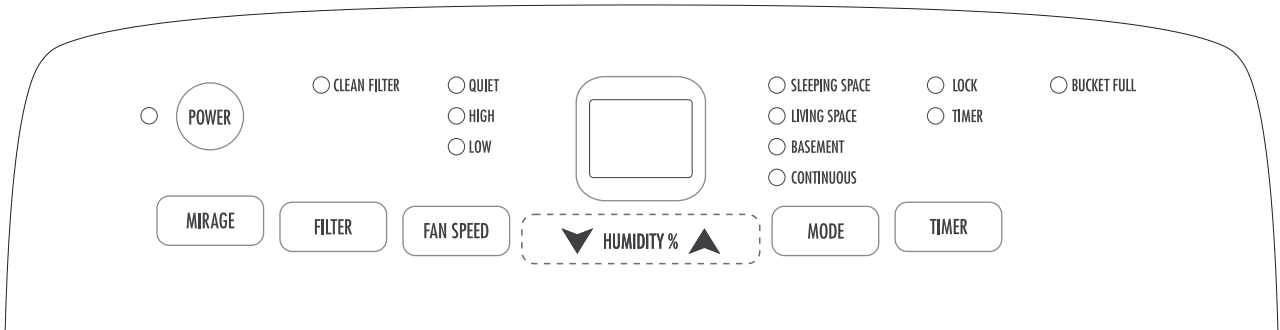

Model: D025P-35Pt3

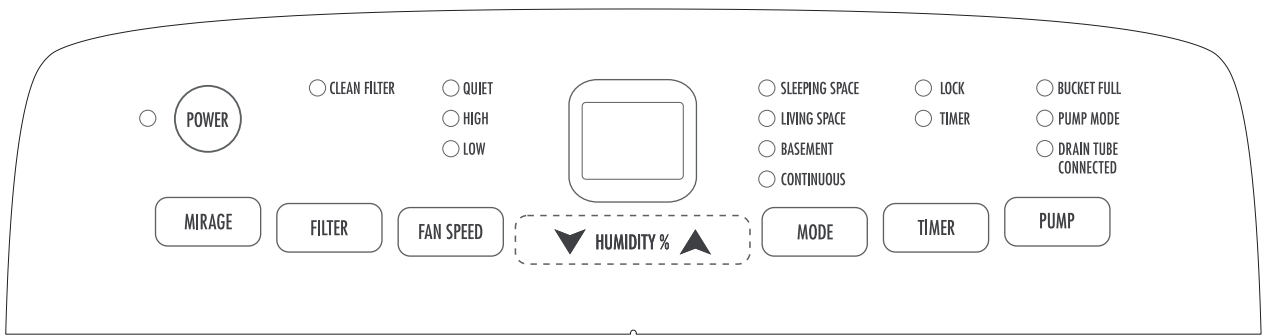

Model: D026P-50Pt3-P

POWER Button

Press to turn the dehumidifier on and off.

MIRAGE Button

The backlit display on the front of the dehumidifier shows the room's actual humidity level. Press the button to activate or deactivate the humidity display.

FILTER Button

When the CLEAN FILTER light is on, clean the filter. Replace the clean filter and switch on the unit.

FAN SPEED Button

Press the button to cycle through high, medium, or low fan modes. Choose medium or low mode for quieter operation.

HUMIDITY Button

When the unit is on, the Display Screen displays the current humidity level. Press ▲ or ▼ to select your desired humidity level in 5% increments, ranging from 35% RH to 80% RH.

MODE Button

Press the button to choose from Sleeping Area (55%), Living Area (50%), Basement (45%) or Continuous Operation.

TIMER Button

- **Timer Auto On:** To set automatic startup, press the button when the unit is off. Use ▲ or ▼ to adjust the timer in 30-minute increments up to 10 hours, then in 1-hour increments up to 24 hours. The unit will turn on once the set time is reached.

- **Timer Auto Off:** To schedule automatic shutdown, press the button when the unit is on. Adjust the timer in the same way as the automatic startup setting. The unit will power off when the designated time is up.
- **Child-Lock:** To lock the control panel, press and hold the TIMER button for 3 seconds, and the LOCK indicator will be on. To unlock the control panel, press and hold the button for 3 seconds.

PUMP Button (Model D026P-50Pt3-P Only)

Press the button to activate the pump mode, allowing for continuous water drainage through the integrated pump system. When engaged, the pump will work automatically to efficiently remove collected water, ensuring uninterrupted dehumidification.

Specifications

| Model | | D025P-35Pt3 | D026P-50Pt3-P |
|--------------|---------------------------------|-----------------|--------------------|
| Pints | | 30 Pints | 50 Pints with Pump |
| Power Supply | | 115V/60Hz | 115V/60Hz |
| Performance | Rated Input | 376W | 527W |
| | Rated Current | 3.3A | 4.63A |
| | Dehumidifying Capacity | 35.57 Pints/Day | 49.72 Pints/Day |
| | Bucket Capacity | 8.5 Pints | 14.8 Pints |
| | Air Flow Volume(High/Low/Quiet) | 131/116/101 CFM | 188/168/151 CFM |
| System | Recommend Room Size | 2,500 sq.ft | 3,500 sq.ft |
| | Noise Level | ≤53dB(A) | ≤53dB(A) |
| | Working Temperature | 45°F-89°F | 45°F-89°F |
| | Timer | 0-24Hrs | 0-24Hrs |

Water Removal

The dehumidifier offers 3 options for removing collected water.

Option 1: Drain Bucket

When the water bucket becomes full, the BUCKET FULL indicator light will activate, the operation will automatically stop, and the buzzer will emit three beeps to alert you to empty the water bucket.

To empty the water bucket, follow the steps:

1. Gently press on both sides of the bucket with your hands and pull it out.
2. Empty the collected water.

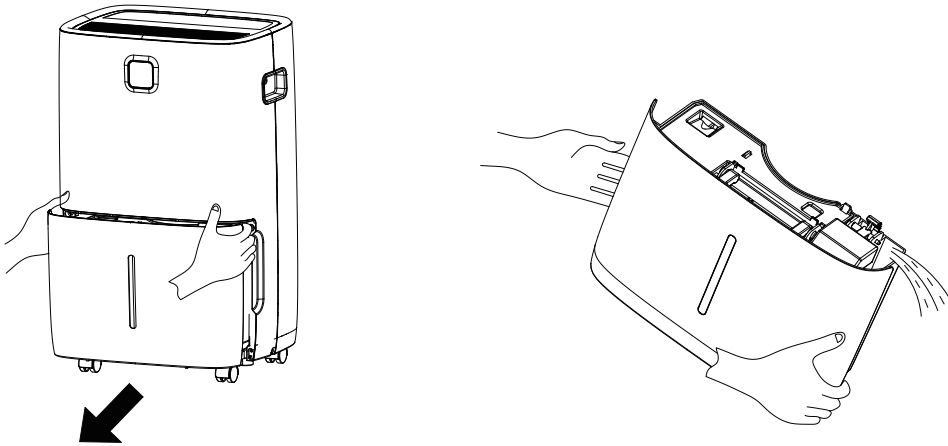

Notes:

- Do not remove the float from the water bucket, as doing so will prevent the water full sensor from detecting the water level, potentially causing water leakage.
- If the drain bucket becomes dirty, clean it with cold or lukewarm water. Do not use detergents, scouring pads, chemically treated dust cloths, gasoline, benzene, thinner, or other solvents, as they may scratch and damage the bucket, leading to water leakage.
- When reinserting the drain bucket, firmly press it into place using both hands.

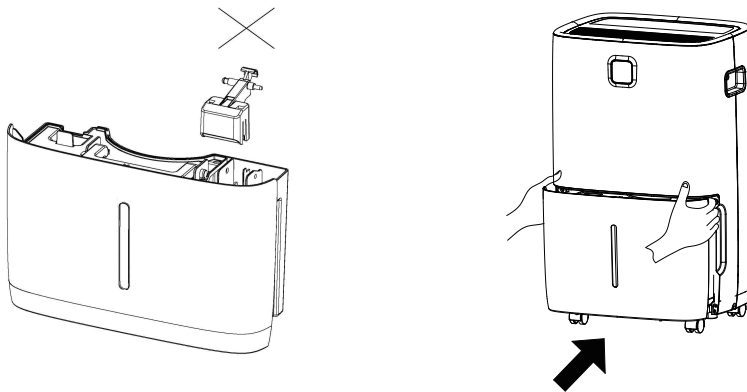

Option 2: Continuous Drainage

Water can be automatically drained by attaching a drain hose to the drain outlet located on the back of the dehumidifier. This setup allows the unit to run continuously, depending on your selected humidity level, without the need to empty the water bucket.

1. Remove the drain cap.
2. Securing the drain adapter by turning it clockwise onto the drain outlet.
3. Connect a drain hose to the drain adapter.
4. Ensure the hose is free from kinks and confirm a secure hose installation.
5. Turn on the unit and set it to **CONTINUOUS** mode using the **MODE** button.

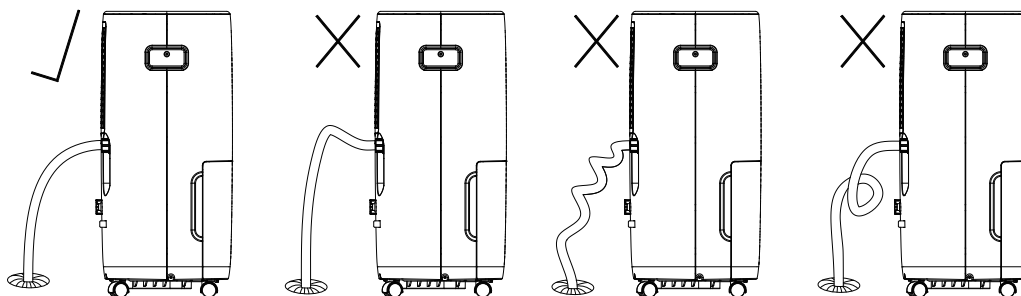

Notes:

- Make sure the drain hose is secure so there are no leaks.
- Placing the dehumidifier on an uneven surface or improper hose installation may result in the water bucket filling up, causing the unit to shut off. If a shut-off occurs, empty the bucket, and check the dehumidifier's location and the hose for correct setup.
- The bucket must be in place and securely seated for the dehumidifier to operate effectively.

Option 3: Pump Drainage (Model D026P-50Pt3-P Only)

The internal pump allows the unit to operate without having to empty the bucket. To set up the pump drain hose kit, follow the steps:

1. Remove the drain cap.
2. Securing the pump adapter by turning it clockwise onto the drain outlet.
3. Connect the pump drain hose to the pump adapter.
4. Ensure the hose is free from kinks and confirm a secure hose installation.
5. Extend the hose to a nearby drain or sink, ensuring it's no higher than 16ft from the unit's base.
6. Turn on the dehumidifier, and press the pump button to activate the internal pump.

Notes:

- The pump mode is only operational with the pump drain hose and pump adapter. Do not use the drain hose for continuous drainage, or any other hoses in pump mode.
- Make sure the drain hose is secure so there are no leaks.

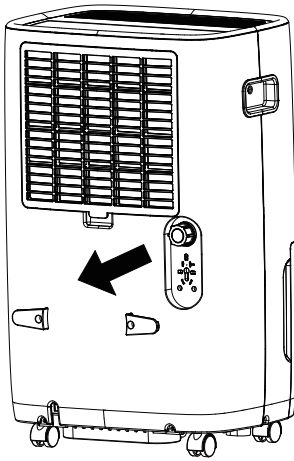

Pump Adapter

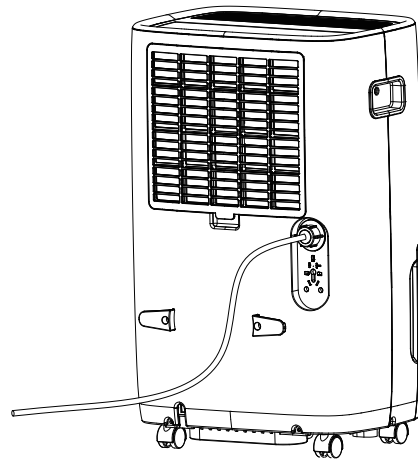
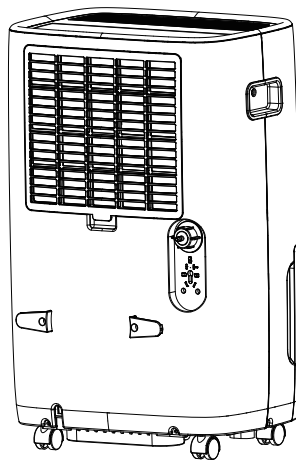

Pump Drain Hose



Pump Adapter Storage Compartment

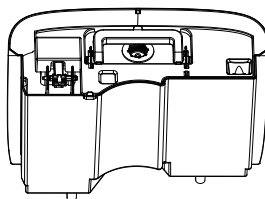

Maintenance

WARNING

- Always turn off the dehumidifier and unplug it from the electrical outlet before cleaning or maintenance.
- Never clean the unit's parts with flammable fluids. Do not use an excessively wet cloth, industrial solvents, and oil-based products to clean this unit.
- Do not store or use gasoline or any other flammable vapors and liquids in the vicinity of this or any other unit.

Cleaning the Case

Use water and a mild detergent to clean the case. Avoid using bleach or abrasive cleaners.

Cleaning the Bucket

Every few weeks, thoroughly clean the bucket to prevent mold, mildew, and bacteria growth. Fill the bucket with clean water and mild detergent. Swirl it around, then empty and rinse.

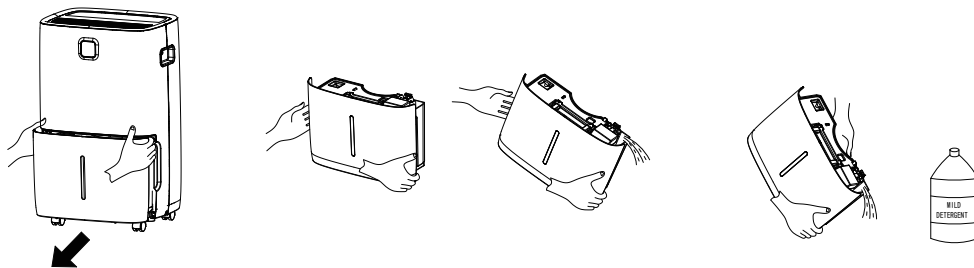

Cleaning the Air Filter

1. Pull it outwards to removal the filter.
2. Wash the filter with clean water and allow it to dry.
3. Re-install the filter .

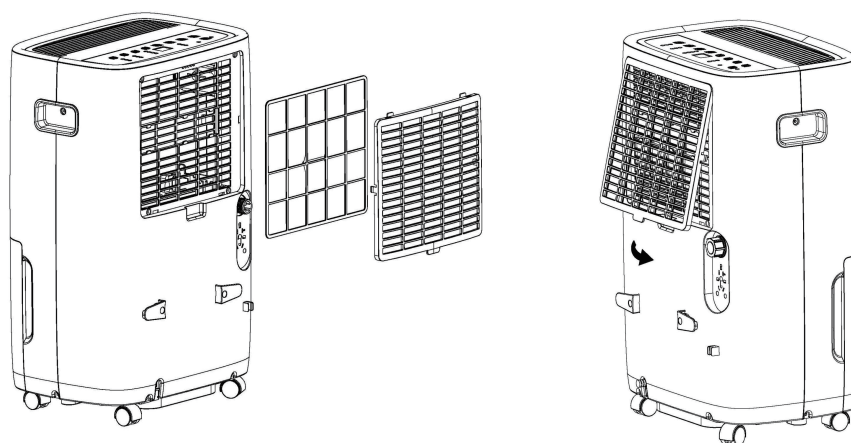

Storing the Dehumidifier

- Before storing the unit, allow it to rest for a full day to let the system dry out naturally.
- Clean the unit, water bucket, and air filter.
- Secure the power cord using the power cord buckle.
- Cover the unit with a plastic bag.
- Store the unit in an upright position in a dry, well-ventilated area.

Troubleshoot your problem by using the chart below. If the dehumidifier still does not work properly, contact customer service. Customers must never troubleshoot internal components.

Troubleshoot

| Trouble | Possible Remedy |
|--|--|
| The Dehumidifier Does Not Start | Ensure that the dehumidifier's plug is fully inserted into the outlet. |
| | Check the house fuse or circuit breaker box and replace the fuse or reset the breaker if needed. |
| | Verify if the dehumidifier has reached its preset humidity level or if the water bucket is full. |
| | Make sure the water bucket is correctly positioned. |
| | Note that there is a protective time delay (up to 3 minutes) designed to prevent overloading the compressor. As a result, the unit may not initiate normal dehumidification for the first 3 minutes after being powered back on. |
| Dehumidifier Does Not Dry the Air as Expected | Ensure that you have allowed enough time for the dehumidifier to remove moisture from the air effectively. |
| | Check for any obstructions such as curtains, blinds, or furniture that may be blocking the front or back of the dehumidifier, impeding its performance. |
| | Verify that the humidity control is set to an appropriate and lower level. |
| | Make sure that all doors, windows, and other openings are securely closed to prevent external moisture from entering the room. |
| | Check the room temperature, ensuring it is not too low and falls below 5C (41°F). Identify any potential sources of water vapor within the room, as this can affect the dehumidifier's efficiency. |
| Loud Noise During Operation | Check if the air filter is dirty and clean it. Refer to the Care and Cleaning & Maintenance section. |
| | Ensure that the unit is placed upright as intended, not tilted. |
| | Confirm that the floor surface is level to reduce vibrations and noise. |
| Frost on Coils | This is normal; the dehumidifier has an auto defrost feature. |
| Water on the Floor | Check for loose hose-to-connector or hose connection. |
| | Ensure that you are using the bucket to collect water and that the back drain plug is not removed. |
| Continuous Mode with Water in the Bucket | Ensure that you are using a garden hose while operating in Continuous Mode. |

Self-diagnosing Codes

| Trouble | Possible Cause | Possible Remedy |
|-----------------|--------------------------------|-------------------------------|
| Error Code "E1" | Compressor Overheat Protection | Contact the customer service. |
| Error Code "E2" | Condenser Overheat Protection | |
| Error Code "EH" | Humidity Sensor Malfunction | |
| Error Code "E5" | Internal Pump Malfunction | |

Customer Service

Warranty

- **1-Year Warranty**

All DENBIG Products come with a 1-year warranty from the date of purchase. DENBIG warrants to the original purchaser that the product will be free from defects in material, parts and workmanship, and replaces any defective product with a new unit that is equivalent to your original purchase within the warranty period.

- **6-Month Warranty Extension**

You can get a 6-month warranty extension by registering your new product at www.denbig.shop.

Customer Service

If you have any questions or encounter issues with your product, including problems not covered in the Troubleshooting section, or if the recommended solutions do not resolve the problem, please reach out to our customer service for assistance.

✉ denbigofficial@hotmail.com

🌐 www.denbig.shop

Video Guide

Visit our official website to watch a video tutorial at www.denbig.shop.



DENBIG

DEHUMIDIFIER

Instruction Manual

Before using this product, please read this manual carefully and keep it for future reference.

🌐 www.denbig.shop

✉ denbigofficial@hotmail.com