

Shinco®



SPF2-08CG

Portable Air Conditioner

*Compact Home AC Cooling Unit with Built-in Dehumidifier
& Fan Modes, Includes Window Mount Kit (8,000 BTU)*

USER GUIDE

CONTENT

Important Safety Tips

Precautions.....	3
------------------	---

Product Introduction

Main Parts and Components.....	7
--------------------------------	---

Control Panel and Remote Controller.....	9
--	---

Product Operation

Placement and Installation.....	10
---------------------------------	----

Operation Method.....	11
-----------------------	----

Clean and Maintenance

Drainage Method.....	12
----------------------	----

Maintenance.....	13
------------------	----

Common Failures and Diagnosis

Intelligent Error Detection.....	14
----------------------------------	----

Fuse Parameters.....	14
----------------------	----

Troubleshooting.....	14
----------------------	----

Features and Technical Specifications	15
---	----

Important Safety Tips

Precautions

Please read the Manual carefully before operating the machine:

- This machine is for household use only.
- This machine is for indoor use only. Please place it in dry environment.
- Check power cord frequently. If power cord, plug or A/C is damaged, please don't operate. Cable should not scatter at places where power cord may be pulled out or people may be stumbled.
- The A/C should be away from heat source and avoid direct sunlight.
- Turn off the A/C before unplugging.
- Turn off and unplug the A/C before removing or cleaning it, or replacing its parts or when it is not used.
- Clean the A/C according to the Manual.
- Voltage of the A/C should meet requirements. Any damage incurred by incorrect power isn't included in the warranty.
- Children are not allowed to play with the A/C.

This appliance is not intended for use by children, unless they have been given supervision or instruction concerning use of the appliance by a person responsible for their safety.

- Don't insert your fingers or any hard object to wind guide bar of the air outlet.
- Don't place the A/C at any place with water or other liquid. Prevent water or liquid from entering the A/C.
- Don't repair the A/C by yourself. Any possible hazard incurred by maintenance of laypeople will violate the warranty. If the supply cord is damaged, it must be replaced by professional maintenance personnel.
- Please use the accessories provided by the A/C manufacturer; otherwise, the A/C may be damaged.
- Cleaning and user maintenance shall not be made by children without supervision.

READ ALL INSTRUCTIONS BEFORE USE.

Your safety and the safety of others are very important.

We have provided many important safety messages in this manual and on your appliance. Always read and follow all safety messages.



This symbol shows that this appliance uses a flammable refrigerant. If the refrigerant is leaked and exposed to an external ignition source, there is a risk of fire.

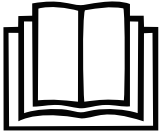

This symbol shows that the operation manual should be read carefully.

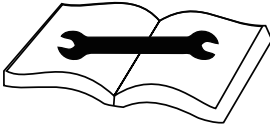

This symbol shows that a service personnel should be handling this equipment with reference to the installation manual.

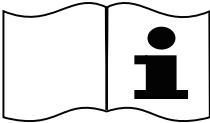

This symbol shows that information is available such as the operating manual or installation manual.

▲ REFRIGERANT (FOR R32 ONLY)



CAUTION ON FIRE

READ THE MAUAL CAREFULLY BEFORE USING THE APPLIANCE R32 refrigerant gas complies with International environmental directives.

▲ Warnings

- ▲ Do not use means to accelerate the defrosting process or to clean, other than those recommended by the manufacturer.
- ▲ The appliance shall be stored in a room without continuously operating ignition sources (for example: open flames, an operating gas appliance or an operating electric heater).
- ▲ Do not pierce or burn.
- ▲ Be aware that refrigerants may not contain an odour.
- ▲ The instructions should contain the following information :
That piping material, pipe routing, and installation shall include protection from physical damage in operation and service, and be in compliance with national and local codes and standards, such as ASHRAE 15, IAPMO Uniform Mechanical Code, ICC International Mechanical Code, or CSA B52.
All field joints shall be accessible for inspection prior to being covered or enclosed.
 - The installation of pipe-work shall be kept to a minimum.
 - The provision shall be made for expansion and contraction of long runs of Piping;
 - The protection devices, piping, and fittings shall be protected as far as possible against adverse environmental effects, for example, the danger of water collecting and freezing in relief pipes or the accumulation of dirt and debris;
 - The piping in refrigeration systems shall be so designed and installed to minimize the likelihood of hydraulic shock damaging the system;
 - The steel pipes and components shall be protected against corrosion with rustproof coating before applying any insulation;

- The flexible pipe elements shall be protected against mechanical damage, excessive stress by torsion, or other forces, and that they should be checked for mechanical damage annually;

▲ When using the product, the room should keep any required ventilation openings clear of obstruction. Notice that servicing shall be performed only as recommended by the manufacturer.

Unventilated area

- That an unventilated area where the appliance using flammable refrigerants is installed shall be so constructed that should any refrigerant leak, it will not stagnate so as to create a fire or explosion hazard.
- ▲ The non-fixed appliance shall be stored in an area where the size corresponds to the room area as specified for operation.
- ▲ The non-fixed appliance shall be stored in a room without continuously operating open flames or other potential ignition sources.
- The manufacturer should specify other potential continuously operating sources known to cause ignition of the refrigerant used.
- The appliance shall be stored so as to prevent mechanical damage from occurring.
- Non-duct connected appliances containing A2L refrigerants with the supply and return air openings in the conditioned space may have the body of the appliance may be installed in open areas such as false ceilings not being used as return air plenums, as long as the conditioned air does not directly communicate with the air of the false ceiling.

Qualification of workers

- All operators or refrigeration circuit maintenance personnel should obtain a valid certificate issued by an industry-recognized evaluation agency to determine that they have the qualifications to safely handle refrigerants as required by the industry-recognized evaluation scope.
- Only perform equipment maintenance and repairs in accordance with the methods recommended by the appliance manufacturer. If other professional is required to assist in maintenance and repairs, they should be carried out under the supervision of personnel qualified to use flammable refrigerants.

Special Warning:

- Place the A/C on even ground and install it vertically, so as to ensure normal operation of the compressor.
- The A/C should be at least 50cm away from surrounding objects. Keep air inlet and outlet smooth.
- Don't use the A/C beside gasoline or any other inflammable liquid .
- Don't use spraying agent and other solvent or flammable substances near the A/C; otherwise, its plastic may deform and electric parts may be damaged.

Power

- The plug should be in good condition and can't be damaged. Don't replace the plug with power plug.
- In order to run the A/C, plug the power cord first, and then press the power key.
- Place unit in upright position for 2 hours before turning on for first time.

Product Introduction

MAIN PARTS AND COMPONENTS

1. Handle
2. Control panel
3. Louver
4. Caster
5. Air outlet
6. Air inlet
7. Drainage nozzle
8. Remote controller
9. Exhaust duct assembly
10. Window sealing plate assembly

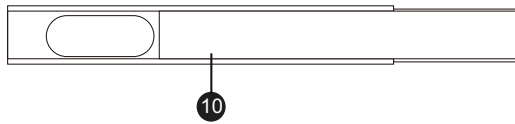
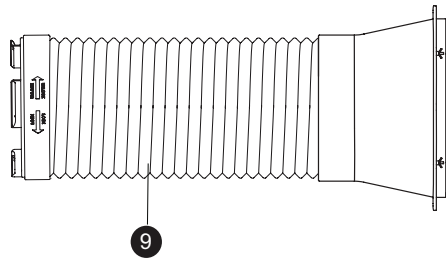
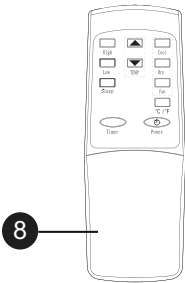
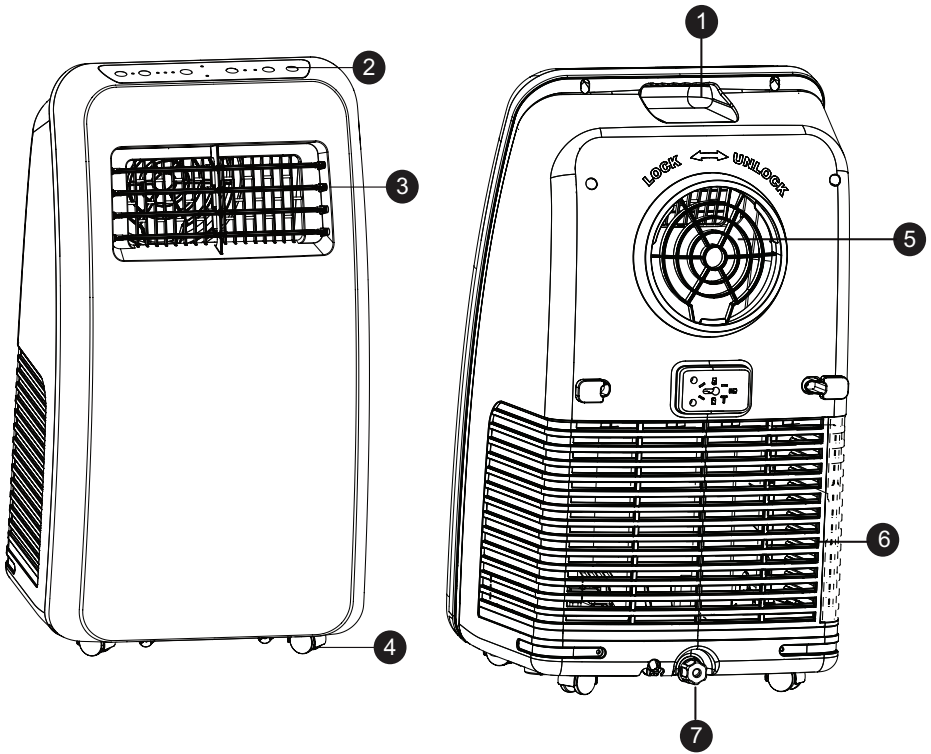

Control Panel and Remote Controller

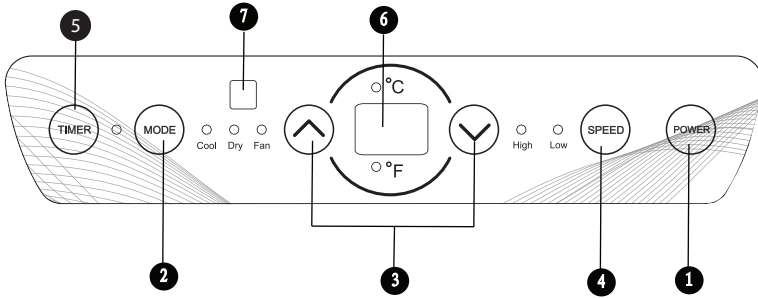

Cooling Model

1.Power key

Press the key to turn ON/OFF the A/C.

2.Mode key

Press the key to choose cool, fan and dry.

3.Temperature/ time adjusting key

Press the key at cooling mode to increase/ reduce the setting temperature; press it at timing mode to adjust time; press Up and Down keys simultaneously to switch Fahrenheit and Centigrade degree temperature.

4.Speed key

Press the key to choose high/low speed.

5.Timer key

Press the key at standby mode to set ON time.

Press this key at ON mode to set OFF time.

6.Temperature/ Time Display Window

Displays the adjusted temperature and time

7.Remote controller receiving window

It is used to receive signal of the remote controller.

8.°C/°F switching key

Press the key to switch °C and °F

9.Sleep key

In the cooling mode, the sleep mode can be selected by this key

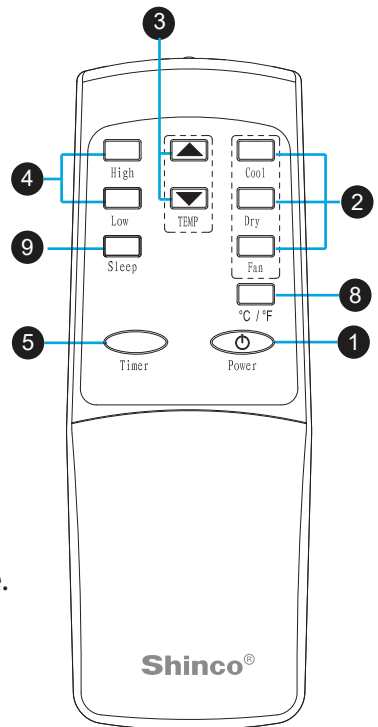

Product Operation

Placement and Installation

Placement

- Place it at even and dry place, and keep it at least 50cm. away from its surrounding object.

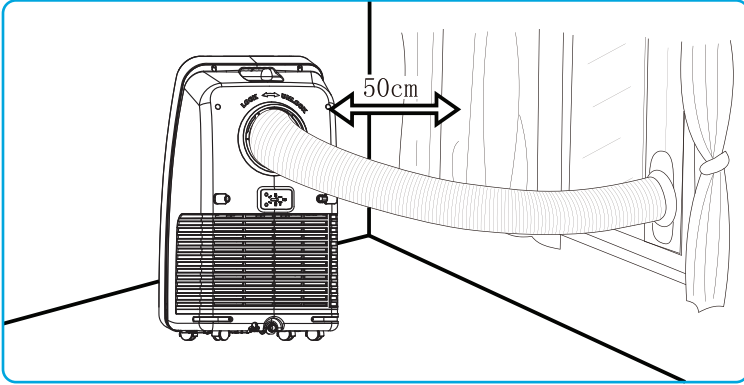

Installation

- Screw the exhaust duct assembly in the air outlet behind the panel (counterclockwise).

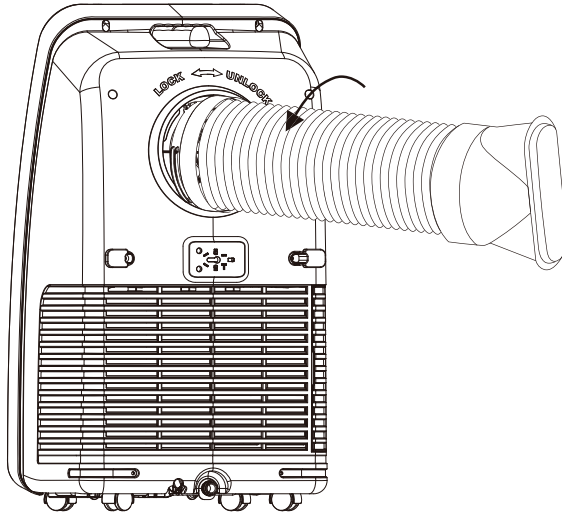

- Insert the air exhaust hose into the window sealing plate, adjust opening width of window so that the window can match with the sealing plate properly; length of the sealing plate is adjustable.

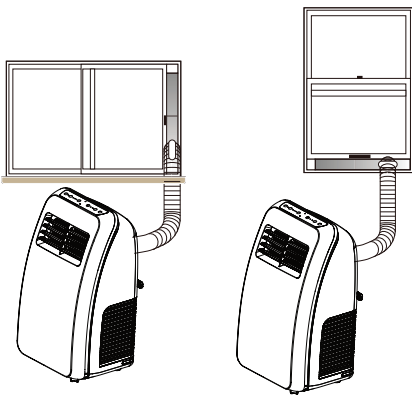

Best Installation

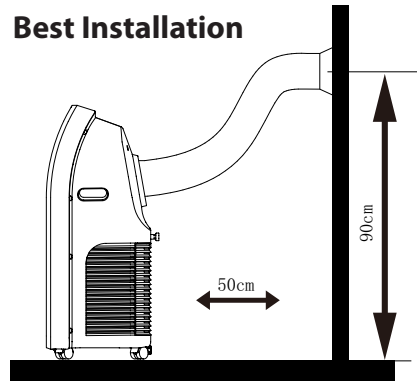

Incorrect Installation

- It's important to keep the exhaust duct smooth. Incorrect installation will affect work of the A/C.
- Prevent the exhaust duct from sharp bending.
- Ensure air can flow smoothly in the duct.

Warning:

The exhaust duct is designed especially for this model. Don't replace or lengthen it; otherwise, it will result in failure.

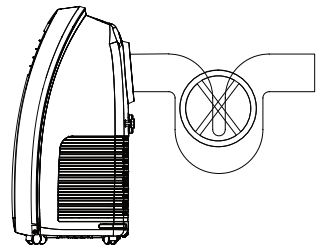

Notice:

Max. developed length of the exhaust duct is 1,500mm. It's better to shorten it while in use and keep it horizontal while installation.

OPERATION METHOD

Plug in the unit and in standby mode, the ambient temperature will shows on the display screen, you can choose the working mode (Cool or Heat) and the desired temperature according to the ambient temperature. Also, the ambient temperature will shows on the display under Fan Mode and the Dehumidification Mode, and temperature setting is not available in those two modes.

Cooling Mode

- When the A/C enters cooling mode automatically or cooling mode is selected after power ON, the cooling indicator lamp lights up.
- Press Up/Down key to adjust setting temperature (16°C~30°C)(60°F~86°F).
- Press Speed key to choose High/Mid/Low speed.

Fan Mode

- When pressing mode key or choosing Fan mode by pressing the remote controller, the wind indicator lamp lights up.
- Press Speed key to choose High/Mid/Low speed.
- Temperature can't be set.

Dehumidification Mode

- When pressing mode key or choosing dehumidification mode by pressing the remote controller, the dehumidification indicator lamp lights up.
- Remove the dehumidification water wedge, insert water manifold, place the other end of the water manifold into the water vessel or drainage passage, as shown in the right figure.
- After entering the dehumidification mode, if room temperature $\geq 17\text{ }^{\circ}\text{C}$ (62°F), the compressor is ON. Then control as follows: when room temperature $\leq 15\text{ }^{\circ}\text{C}$ (59°F), the compressor is OFF; when temperature increases to room temperature $\geq 17\text{ }^{\circ}\text{C}$ (62°F), the compressor will start again (in order to protect the compressor, it will be restarted 3min. later).
- In dehumidification mode, the fan is defaulted to run at low speed, and wind speed can't be adjusted.
- Temperature can't be set.

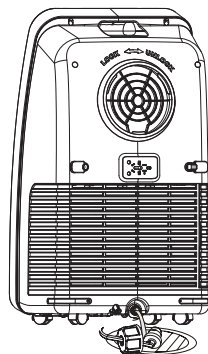

Note: When use dehumidify function, should remove exit pipe components, otherwise, it will cause worse dehumidify performance, and appear “FL” water full alarm

Sleep mode (optional function)

- Under cool mode, pressing sleep mode key on the remote controller or pressing time key and down key together on the machine, it will start sleep mode with low wind speed and can't be adjusted. Pressing the sleep mode key again or pressing time key and down key together on the machine to quit the sleep mode.
- If you press the wind speed key under the sleep mode, the screen will display “SL”

Timer Mode

- In standby state, press the Timer key to set ON time. Press Up and Down keys to set ON time (0~24H), and the timer indicator lamp lights up.
- In ON state, pressure the timer key to set OFF time. Press Up and Down keys to set OFF time (0~24H), and the timer indicator lamp lights up.

Clean and Maintenance

DRAINAGE METHOD

This product is equipped with automatic water vaporization system. The condenser is cooled with the circulating of condensing water, so as to improve cooling efficiency and save energy.

- If the internal vessel is full of water, the display screen will display “FL”, and the compressor stops working automatically. After power off, unscrew the water cover, pull out the water plug to drain off water, and it will become normal after being restarted.

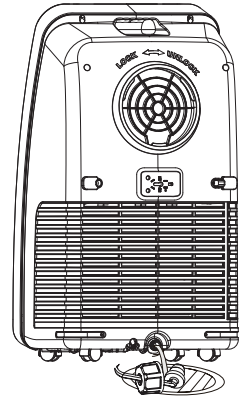

MAINTENANCE

Notice: In order to avoid electric shock, please turn off the A/C and unplug before maintenance or repair.

CLEANING

- Unplug before cleaning.
- Wipe with soft semi-dry cloth. Don't use chemical reagent, such as benzene, alcohol and gasoline etc; otherwise surface of the A/C and even the whole A/C will be damaged.
- Prevent water from spattering in the A/C.

FILTER SCREEN

- Wash the filter screen once every two weeks. If it is blocked by dust, efficiency of the A/C will be reduced.
- Take out the air inlet grille and pull out the filter screen at both sides according to the direction shown in the following figures.
- Put the filter screen into the warm water (about 40°C or 104°F) added with neutral detergent, dry it at a shady place after cleaning.

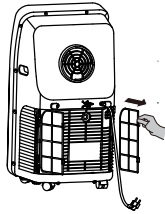
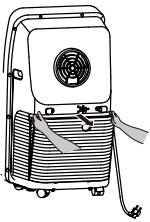

If filter is dirty, clean in 40°C (104°F) warm water or in water with neutral detergent.

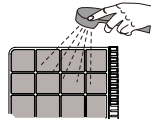
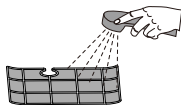
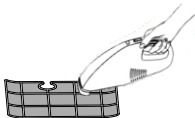

If filter is not that dirty, clean the dust with a vacuum cleaner.

SEASONAL CLEANING

If the A/C will not be used for a long time:

- Pull out the water plug to drain.
- Run the A/C in fan mode for 2H till the inside is dry.
- Turn off the A/C and unplug .
- Wash the filter screen and reassemble it.
- Dismantle the exhaust duct and keep it properly.
- Cover the A/C with a plastic bag and place it at a dry place.

Common Failures and Diagnosis

Intelligent Error Detection

Error-detecting code	Multi-functional defection
E1	Error of the coil's temperature sensor
E2	Error of indoor temperature sensor
E4	Anti-freezing protection: temperature of the coil is too low and the whole A/C is off . When temperature exceeds 8°C or 46.4°F, the protection is released and previous working state is recovered.

FUSE PARAMETERS

- **Voltage:** 250VAC
- **Current:** 3.15A

Troubleshooting

In case of any of the following trouble, please contact professional maintenance personnel in time.

TROUBLE	CAUSE	SOLUTION
The A/C doesn't work	No display	Reset circuit breaker on AC cord
	The display panel displays "FL"	Restart the A/C after power off and draining, then it will become normal
	Time OFF function is started	The A/C can be restarted 3 minutes after being turning off.
The A/C starts frequently	Direct sunlight	Draw the curtain
	Doors and windows keep open; there are lots of people or heat source in room	Close doors and windows, remove heat source
	Filter screen is very dirty	Clean or replace it
	Air inlet or air outlet is blocked	Remove the stem

Big noise of the A/C	The A/C is placed unevenly	Place it at even and firm ground, avoid shaking
The compressor doesn't work	Its delay protection is started	Wait for 3min., turn on after temperature decreases

Notice: When there is any abnormal to the A/C, turn it off and unplug, and then contact professional maintenance personnel.

The above technical parameters are subject to change without notice.



Do not dispose of electrical appliances as unsorted municipal waste, use separate collection facilities. Contact you local government for information regarding the collection systems available. If electrical appliances are disposed of in landfills or dumps, hazardous substances can leak into the groundwater and get into the food chain, damaging your health and well-being. When replacing old appliances with new ones, the retailer is legally obligated to take back your old appliance for disposals at least free of charge.

SPF2-08CG

Portable Air Conditioner

Compact Home AC Cooling Unit with Built-in Dehumidifier & Fan Modes, Includes Window Mount Kit (8,000 BTU)

Features:

- Lightweight & Portable A/C Unit
- Compact Freestanding Room Air Conditioner
- (3) Operation Modes: AC Cooling / Dehumidifier / Fan
- Hassle-Free, Quick Setup Cooling
- Simple Electric Plug-in Operation
- Convenient Wide-Area Climate Control Room AC Coverage
- Digital Touch Button Control Panel with LED Display
- Time, Temperature & Fan Speed Adjustment Settings
- Includes Universal Window Mount AC Exhaust Kit
- Removable & Washable Air Filter Screen

- Modern Style, Sleek Body Housing
- Energy Efficient: Low Power Consumption
- Low Noise Level Motor
- Rolling Wheels for Easy Portability
- Used for Home, Office, School & Business Rooms

What's in the Box:

- AC Unit
- Exhaust Hose
- Window Installation Plate
- Remote Control



This product can expose you to a chemical or group of chemicals, which may include "Acrylonitrile" which is known in the state of California to cause cancer, birth defects, or other reproductive harm. For more info, go to

WARNING: <https://www.p65warnings.ca.gov/>.