







## Duplex Receptacle Wallplates

Description	Color	Thermoplastic			Material	Metal Catalog Number
		Standard	Mid-Size	Jumbo		
1-Gang, 1-Duplex 	Black	<b>P8BK</b>	<b>PJ8BK</b>	-	Aluminum Brass Brass Plated Chrome S/S 302/304 S/S 430	<b>SA8</b>
	Blue	-	<b>PJ8BL</b>	-		<b>SB8</b>
	Brown	<b>P8</b>	<b>PJ8</b>	-		<b>SBP8</b>
	Gray	<b>P8GY</b>	<b>PJ8GY</b>	-		<b>SCH8</b>
	Ivory	<b>P8I</b>	<b>PJ8I</b>	<b>NPJJ8I</b>		<b>SS8</b>
	Light Almond	<b>P8LA</b>	<b>PJ8LA</b>	<b>NPJJ8LA</b>		<b>SS8L</b>
	Orange	<b>P8OR</b>	-	-		
	Red	<b>P8R</b>	<b>PJ8R</b>	-		
	White	<b>P8W</b>	<b>PJ8W</b>	<b>NJJ8W</b>		
	2-Gang, 2-Duplex 	Black	<b>P82BK</b>	<b>PJ82BK</b>		-
Brown		<b>P82</b>	-	-	<b>SB82</b>	
Gray		<b>P82GY</b>	<b>PJ82GY</b>	-	<b>SBP82</b>	
Ivory		<b>P82I</b>	<b>PJ82I</b>	-	<b>SCH82</b>	
Light Almond		<b>P82LA</b>	<b>PJ82LA</b>	-	<b>SS82</b>	
Orange		<b>P82OR</b>	-	-	<b>SS82L</b>	
Red		<b>P82R</b>	<b>PJ82R</b>	-		
White		<b>P82W</b>	<b>PJ82W</b>	-		
3-Gang, 3-Duplex 		Ivory	<b>P83I</b>	-	-	Aluminum Brass Brass Plated Chrome S/S 302/304 S/S 430
	White	<b>P83W</b>	-	-	⓪ ⓪ ⓪ <b>SS83</b> -	
4-Gang, 4-Duplex 					Aluminum Brass Brass Plated Chrome S/S 302/304 S/S 430	⓪ ⓪ ⓪ ⓪ <b>SS84</b> -
2-Gang, 1-Duplex 					Brass Brass Plated Chrome S/S 302/304 S/S 430	- - - <b>SS748</b> -

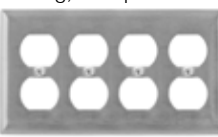
## Single 15/20A Straight Blade or 15A Twist-Lock® Receptacle Wallplates

Description	Color	Thermoplastic			Material	Metal Catalog Number
		Standard	Mid-Size	Jumbo		
1-Gang, 1-Single 1.40 in. (35.6) Dia. Hole 	Black	<b>P7BK</b>	-	-	Aluminum Brass Brass Plated Chrome S/S 302/304 S/S 430	<b>SA7</b>
	Brown	<b>P7</b>	-	-		<b>SB7</b>
	Gray	<b>P7GY</b>	-	-		<b>SBP7</b>
	Ivory	<b>P7I</b>	<b>PJ7I</b>	-		<b>SCH7</b>
	Light Almond	<b>P7LA</b>	<b>PJ7LA</b>	-		<b>SS7</b>
	Red	<b>P7R</b>	-	-		<b>SS7L</b>
	White	<b>P7W</b>	<b>PJ7W</b>	-		
2-Gang, 1-Single 1.40 in. (35.6) Dia. Hole 					Aluminum Brass Brass Plated Chrome S/S 302/304 S/S 430	- - - - <b>SS747</b> -
2-Gang, 2-Single 1.40 in. (35.6) Dia. Hole 					Aluminum Brass Brass Plated Chrome S/S 302/304 S/S 430	⓪ ⓪ ⓪ ⓪ <b>SS72</b> -

Note: Thermoplastic wallplates feature pre-inserted captive screws for faster assembly in single gang configurations.

⓪ Available as a custom wallplate, see pages O-32 to O-34. Consult custom wallplates section for additional openings and combinations.

Dimensions in Inches (mm)

# Floor Boxes

## Above-Floor Service Fittings (Single Service)

Hubbell offers a variety of above-floor service pedestals to satisfy just about any requirement. Large capacity enables a choice of services—you can even create your own unique pedestal to satisfy specific requirements. Above floor service fittings are ideal for furniture feed applications.

### Pedestals – Metallic – LO-CON (single service only)

Traditional metallic pedestals with die-cast aluminum frame, brushed aluminum housing and stainless steel faceplates. These pedestals are offered as component parts. They mount on floor box covers or floor deck/duct systems with  $\frac{3}{4}$  inch or 1 inch threaded openings.

### Create Pedestal – Create your own pedestal to meet specific service requirements. Order housing, face plates and devices separately.



Description	Catalog Number
Frame, housing, $\frac{3}{4}$ in. chase nipple, without plates.	SC3098A
Frame, housing, 1 in. chase nipple, without plates.	SC3099A
Blank plate.	SS309B
Telephone bushing with 1 in. I.D. and (2) $\frac{5}{8}$ in. KO for coax.	SS309T
Single receptacle plate with 1.39 in. (35.3) opening.	SS309S
Duplex receptacle plate.	SS309D
Style Line® decorator plate.	SS309DS

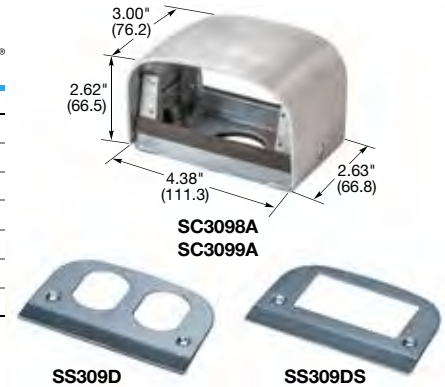

### Furniture Feed Plates – Use with SC3098A or SC3099A housings to feed furniture systems in office settings or display cases in retail applications.

Description	Catalog Number
Aluminum plate with $\frac{3}{4}$ in. trade size knockout.	SS309SF
Aluminum plate, blank.	SS309BF

Note: When using SS309SF on Hubbell's LO-CON pedestals, SS309BF must be used on the opposite side.

### Pedestals – Specialized Service – Large Capacity Pedestals (single service only)



Designed to accommodate receptacles up to 50A (4-gang only). These brushed aluminum pedestals are furnished with either a  $\frac{3}{4}$  inch or 1 inch hub and are designed for mounting to floor box covers with  $\frac{3}{4}$  inch or 1 inch threaded openings. Create your own unique pedestal with a wide choice of stainless steel plates and devices.

Description (2-Gang Housing)	Catalog Number
2-gang aluminum pedestal, grounded (front and back) with $\frac{3}{4}$ in. hub.	SA6685G
2-gang aluminum pedestal, grounded (front and back) with 1 in. hub.	SA6686G

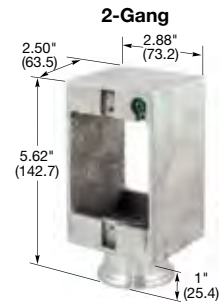

### Plate Option – 1-Gang

Description	Catalog Number
Duplex opening.	SS8
Style Line® decorator opening.	SS26
Single receptacle opening – boss diameter 1.36 to 1.39 in. (34.5 to 35.3).	SS7
Single receptacle opening – boss diameter 1.55 to 1.58 in. (39.4 to 40.1).	SS720
Blank plate.	SS13

Description (4-Gang Housing)	Catalog Number
4-gang aluminum pedestal (2 front and 2 back), with $\frac{3}{4}$ in. hub.	SA6687G
4-gang aluminum pedestal (2 front and 2 back), with 1 in. hub.	SA6688G

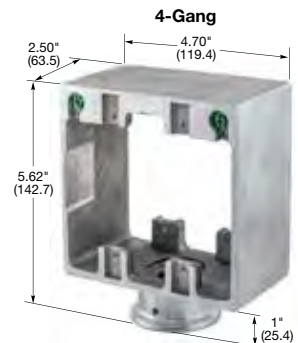

### Plate Option – 2-Gang

Description	Catalog Number
Two duplex openings.	SS82
Two Style Line® decorator openings.	SS262
Two single receptacle openings – boss diameter 1.36 to 1.39 in. (34.5 to 35.3).	SS72
Single receptacle opening – boss diameter 2.41 to 2.44 in. (61.2 to 62.0).	SS701
Single receptacle opening – boss diameter 2.09 to 2.13 in. (53.1 to 54.1).	SS703
Blank plate.	SS23

Dimensions in Inches (mm)