

# OPERATOR'S MANUAL



**A Universal, Battery Powered, Diagnostic Tester for 7-Way Round, 7-Way Flat, 6-Way Round and 4/5 Pin Trailers**



## **LETTER FROM THE PRESIDENT OF IPA®**

My name is Ian Vinci and I would like to thank you for your interest in our products. In today's world, we have all experienced the lack of service and consideration demonstrated by many companies after you buy their products. They say whatever they can to make the sale, and then it's like pulling teeth to get any service response out of them. I know this myself firsthand and because of this, I want to be sure that your experience with IPA® meets your expectations and that IPA® never disappoints you with our service or customer response.

To prove my commitment to you, if for any reason, you are not happy with one of our products, or more importantly, with the response from our customer service department, or any member of the IPA® team, I invite you to contact me directly via my email, [president@ipatools.com](mailto:president@ipatools.com) or call me at 888-786-7899. Your satisfaction is more important to me than the sale itself. We will not be in business for long if we don't make you completely happy with our products and service. I want IPA® to be different and be known for its quality and service.

With that said, please take a look at our product line. You will see innovative first time products that were created to help you do your job faster and better than before. I would also like to invite you to critique our products. If you can think of a better way to make them or changes that will make them work better, please contact me directly and I will be sure to look into it. If you have an innovation and would like some feedback, give me a call.

From all of us at IPA®, we thank you for taking the time to review our product line and wish you and your family the very best of everything.

**Ian Vinci**  
**President**  
**IPA®**

**[www.ipatools.com](http://www.ipatools.com)**  
**Toll Free: 888-786-7899**  
**Phone: 845-679-4500**  
**Fax: 845-679-4600**

# TABLE OF CONTENTS

<b>PART 1: IMPORTANT SAFETY INSTRUCTIONS .....</b>	<b>1</b>
1.1 Important Information .....	1
1.2 Battery Gases, Tester Preparation and Tester/Charger Location...	2
1.3 Lithium Battery Safety/Hazard Information.....	2
1.4 General Charger Use .....	3
<b>PART 2: WHAT'S INCLUDED .....</b>	<b>4</b>
<b>PART 3: SET-UP .....</b>	<b>5</b>
3.1 Specifications .....	5
3.2 Choosing Battery .....	5
3.3 Installing an Internal Battery .....	5
3.4 Built-In Battery/Power Supply Requirements .....	6
3.5 Shipping with Built-In Battery .....	6
3.6 Auto Shutdown Feature .....	6
<b>PART 4: PRETESTING CHECKLIST .....</b>	<b>7</b>
<b>PART 5: GENERAL CONTROLS AND OPERATIONS .....</b>	<b>8</b>
5.1 Control Panel .....	8
5.2 Left and Right Side Panels .....	9
5.3 Using the 12-Button Remote Control .....	10
<b>PART 6: ELECTRICAL/LIGHTING TESTING .....</b>	<b>11</b>
6.1 Selecting a Circuit .....	11
Auto-Cycle Mode	
6.2 Ground Integrity Test .....	12
Establishing a Chassis Ground	
6.3 Fault Indication .....	13
Open Circuit	
Crossed Circuits	
Short/Overloaded Circuit	
6.4 Activating Hazard Lights .....	15
6.5 All Circuits On (Override) Mode .....	15
<b>PART 7: ABS BLINK CODE DIAGNOSTICS .....</b>	<b>16</b>
7.1 Meritor/WABCO Blink Codes .....	17
7.2 Haldex Blink Codes .....	18
7.3 Bendix Blink Codes .....	23
<b>PART 8: MAINTENANCE .....</b>	<b>26</b>
8.1 Maintenance and Storage .....	26
8.2 Instructions for In- and Out-of-Warranty Repairs .....	27
<b>PART 9: TROUBLESHOOTING .....</b>	<b>29</b>
9.1 FAQ .....	29
9.2 Common System Checks .....	29
9.3 Common Troubleshooting Solutions .....	30
<b>PART 10: TYPICAL TRAILER WIRING .....</b>	<b>31</b>
<b>PART 11: OPTIONAL ACCESSORIES AND RELATED PRODUCTS .....</b>	<b>32</b>

# PART 1: SAFETY INSTRUCTIONS

---

## 1.1 Important Information

It is important to read, understand and follow all safety messages and instructions printed in this manual and on the equipment before operating. If safety information is not heeded, serious injury or death to the operator or bystanders may occur.

### Danger

Indicates a hazardous situation, if not avoided, will result in death or serious injury. The possible hazards are shown in the adjoining symbols or explained in the text.

### Warning

Indicates a hazardous situation, if not avoided, could result in death or serious injury. The possible hazards are shown in the adjoining symbols or explained in the text.

### Caution

Indicates a hazardous situation, if not avoided, may result in minor or major injury. The possible hazards are shown in the adjoining symbols or explained in the text.

The following safety alert symbols are used in this manual.

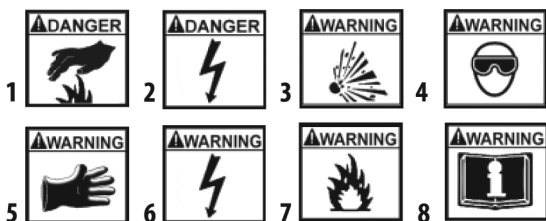

**Symbol 1: Potential burn hazard.** Sparks from electrical shorts can ignite flammable liquids such as fuel or oil. Heat from electrical overloads can cause fire hazards.

**Symbol 2: Potential electrical hazard.** Batteries have enough electrical energy potential to ignite flammable liquids such as fuel or oil. Wire overloads can cause electrical failures. Shock hazard exists.

**Symbol 3: Potential explosive air hazard.** Pneumatic pressures used with this equipment can cause explosive failures on damaged equipment.

**Symbol 4: Potential eye hazard.** Wear OSHA approved safety glasses. Battery acid and high air pressures create hazardous situations for eyes.

**Symbol 5: Potential chemical burn hazard.** Wear protective gloves. Battery acid is corrosive and can cause skin damage.

**Symbol 6: Potential electrical hazard.** Electrical energy can cause heat and burn hazards.

**Symbol 7: Potential fire hazard.** Use caution with flammable liquids such as fuel and oil. Electrical shorts can ignite flammable liquids and wiring.

**Symbol 8: Important information** is stated.

## 1.2 Battery Gases, Tester Preparation and Tester/Charger Location

### Risk of Explosion

- Gases produced by a battery are highly explosive.
- Wear safety goggles and protective clothing, both users and bystanders.
- Use in an area having at least four air changes per hour.
- Read, understand and follow all instructions for charger, battery, vehicle and any equipment used near battery and charger.
- Do not smoke, strike a match, place metal tools on battery or cause a spark in the vicinity of the battery. When removing battery cables, remove the ground cable first.
- Clean terminals before charging battery. During cleaning, keep corrosive particles from eyes, nose and mouth. Use baking soda and water to neutralize acid and help eliminate airborne corrosion.
- Never allow clamps on charger cables to touch each other.
- Do not expose tester or charger to rain, snow, or wet conditions.
- Do not allow battery gases or acid to contact MUTT® cabinet. Do not place charger directly above or below battery.
- Fill battery to level specified by battery manufacturer using distilled water.
- Do not remove cell caps while charging per manufacturer's instructions.
- Make sure tester cable clamps make tight connections.
- Battery explosion can cause injury.



## 1.3 Lithium Battery Safety/Hazard Information

### Risk of Fire, Serious Injury and/or Property Damage

- Do not modify, disassemble or alter the lithium battery.
- Avoid vibrating, puncturing, tampering, or contacting with metal.
- Only use the provided lithium battery charger.
- Never leave lithium battery unattended while charging.
- Disengage charger if lithium battery gets hot, smokes, swells or becomes odorous.
- If lithium battery leaks fluid onto your skin or in your eyes, rinse well with water and seek medical attention immediately. Do not rub fluid on skin or in eyes. Battery fluid can cause real harm if left untreated.
- Keep out of reach of children.
- Risk of fire is exacerbated if: battery is not recharged shortly after being fully discharged; battery is damaged; battery is defective; battery is used/stored at extreme temperatures; battery is reaching end of life cycle.
- Recharge lithium battery within 24 hours of full discharge.



- Do not charge lithium battery at temperatures below 40°F (4°C).
- Do not expose lithium battery to saltwater or similar fluids.
- Do not drop lithium battery. If battery is dropped, inspect for damage. If damage is found, do not use.
- Discharge lithium battery at temperatures between 4°F and 140°F (-20°C and 60°C).
- Store lithium battery at temperatures between 40°F and 80°F (4°C and 27°C).
- A frequently used lithium battery may be stored at 100% charge. If used infrequently, store lithium battery at 40% to 70% charge.

## 1.4 General Charger Use

### Risk of Electric Shock and Fire



- Before connecting charger to unit, make sure controls are set to OFF.
- Do not remove or bypass the grounding pin.
- Do not operate charger with damaged cord or plug. Replace cord or plug immediately if damage occurs.
- Position power cord and charger cables away from the hood, doors and hot or moving engine parts where they could be damaged.
- Unplug power cord by grasping and pulling on the plug, rather than the cord when disconnecting charger from outlet.
- Charger power cord uses equipment-grounding conductor and a grounding plug. Plug only into a 120V AC outlet that is correctly installed and grounded in accordance with all ordinances and local codes.
- Unplug power cord from outlet before cleaning or maintaining tester and charger. Turning off controls does not reduce the risk of electric shock.
- Do not operate charger after a sharp impact, drop or any other damage. Do not disassemble charger.
- Use only recommended attachments.
- Do not charge a frozen battery.
- Do not overcharge a battery.
- Electric shock or fire can cause injury.

### Risk of Entanglement

- Keep yourself, clothing and battery charger leads clear of moving parts such as fan blades, pulleys, hood and doors.
- Moving parts can cause injury.

### Risk of Burns

- Batteries can produce short circuit current high enough to weld jewelry such as rings, bracelets and watches. You must remove them before working near batteries.
- Short circuits can cause injury.

# PART 2: WHAT'S INCLUDED

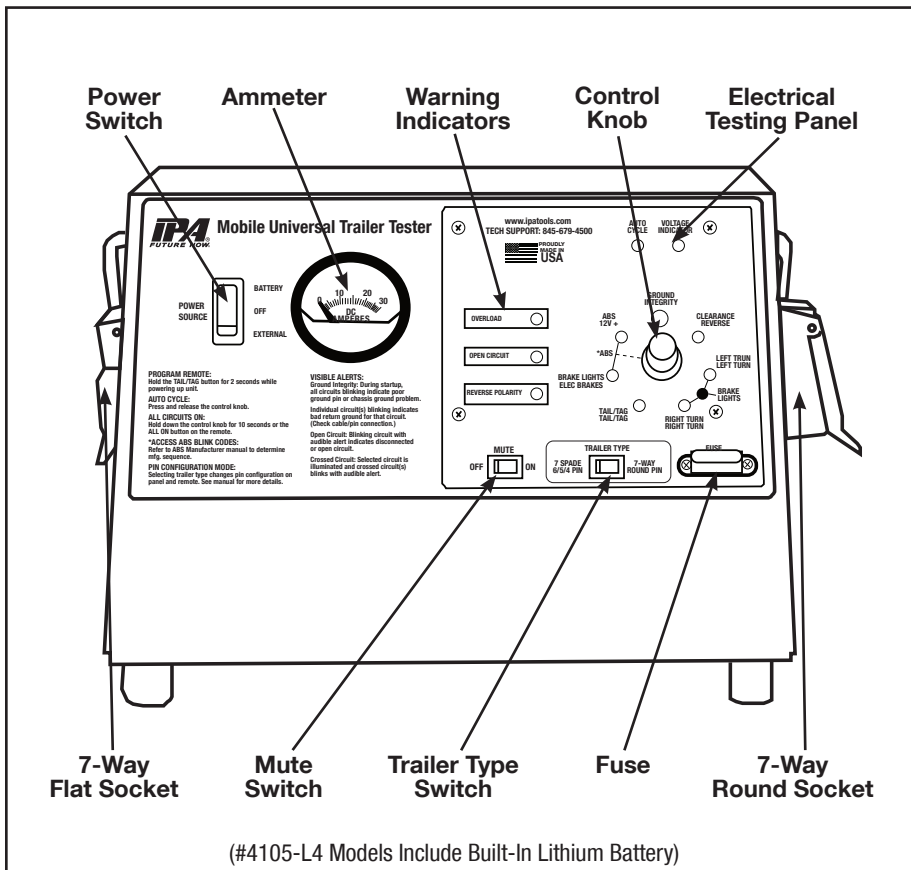

## Included Parts and Accessories:

12-Button Remote Control  
#MUT-RM12-4100



500mA Battery Charger  
#CHR001



3-Way Trailer Adapter  
#8000



Use the Provided Reference Numbers When  
Ordering Products and Parts Above  
Toll Free: 888-786-7899

## PART 3: SET-UP

---

### 3.1 Specifications

<b>Connection Type:</b>	7-Way Round, 7-Way Flat, 6-Way Round. 4/5 Pin
<b>Power Input:</b>	12V DC
<b>Ammeter:</b>	1A—21A
<b>Source Output:</b>	20A @ 12V DC
<b>Controls:</b>	Remote or Manual
<b>Microprocessor:</b>	2020 High-Speed
<b>Materials:</b>	16 ga. Powder-Coated Steel
<b>Weight:</b>	11.4 lbs
<b>Dimensions:</b>	15" L x 9.75" W x 9" H

### 3.2 Choosing a Battery

(Manufacturer's Suggested Replacement: YUASA #YTX14 or Group 14 Equivalent)

- Battery Voltage: 12/24V DC
- Battery Type: Lead-Acid
- Battery Compartment Dimensions: 5 7/8" L x 5 3/4" H x 3 3/8" W
- Battery Protection: In-line 30 amp Fuse for Overcharge

### 3.3 Installing an Internal Battery

1. Remove the four 8/32" x 1/4" Phillips head screws in the back of the MUTT®.
2. Slide out the battery tray.
3. Place the battery onto the tray with the battery terminals facing the front of the unit. Attach the ring terminal of the red wire to the positive side of the battery and tighten securely.
4. Cover positive terminal with the red boot.
5. Attach the ring terminal of the black wire to the negative battery terminal.
6. Carefully slide the tray into the tester. Use caution – DO NOT ALLOW the positive battery terminal to contact the unit.
7. Reinstall screws to secure.

**DO NOT**  
**Use 24 Volts on a Trailer**  
**Wired for 12 Volts!**

### **3.4 Built-In Battery/Power Supply Requirements**

The SMART MUTT® X with Built-In Battery (#4105-L4) model is shipped with an internal LiFePO4 (Lithium Iron Phosphate) battery. It should only be charged with the supplied battery charger. The use of another type of battery charger will void the product warranty.

### **3.5 Shipping with Built-In Battery**

Lithium batteries should never be air shipped fully charged. They must be discharged to less than 30% capacity. The voltage of the battery should read 12.9V or less prior to shipping the battery.

### **3.6 Auto Shutdown Feature**

If left inactive for a period of 20 minutes, the SMART MUTT® X will enter a Sleep mode and power down.

- A sound is emitted every 20 seconds during Sleep mode.
- Activation of the control knob will cancel Sleep mode.

# PART 4: PRETESTING CHECKLIST

*The pretesting checklist should always be completed prior to using the SMART MUTT® X.*

---



## Unit Placement

- Place the tester on a flat, level surface.



## Maintain Connectors

Dielectric grease should be used on all connections to avoid corrosion. If a bad connection exists at the terminal junction, you may get an erroneous reading and the MUTT® will not work properly.

- Make sure you have a solid connection in the socket.
- Be certain the 7 pins in each plug are clean and spread to the proper size.
- Always check the MUTT® connector pins at the side of the MUTT® for proper expansion. Over time, the pins may bend in slightly resulting in a poor connection between the connector and the cable ends. A flat head screwdriver can be used to expand the pins until a tight connection is made.



## Trailer Configuration Set-up

The SMART MUTT® X is a microprocessor controlled, diagnostic trailer tester specifically designed for testing lights and electric brakes on trailers with 4, 5, 6, 7-way round pin and 7-way flat (spade) pin type connections. Every time you power up the tester with the Trailer Type switch in the 7-WAY SPADE 6/5/4 PIN position, the internal computer wants to know which of these types of trailer connections you are testing. Note, this phase is known as Trailer Configuration Set-Up and is indicated by a high speed flickering of the LEDs surrounding the control knob only when in 7-WAY SPADE 6/5/4 PIN mode. If left untouched after 15 seconds, the tester will always default to a 7-way flat pin configuration. However, if the user is testing a 4, 5 or 6-way round pin type trailer connection, this setting can be adjusted by rotating the control knob counterclockwise to select the desired number of circuits. Trailer Configuration Set-Up is not initiated when the unit is powered up in 7-WAY ROUND PIN mode.

## Testing 4, 5, and 6-Way Round Pin Type Trailer Connections

The SMART MUTT® X is hard wired to a 7-way flat (spade) pin connector, located on the side of the tester. Each unit is supplied with a plug-in adapter, which will adapt the tester to 4, 5 and 6-way round pin type connections. To test trailers with these types of connections, the adapter must be plugged in line between the tester and the trailer. The instructions above for Trailer Configuration Set-Up should be used for more efficient and accurate testing.

Call 888-786-7899 with any technical questions.

# PART 5: GENERAL CONTROLS AND OPERATIONS

## 5.1 Control Panel

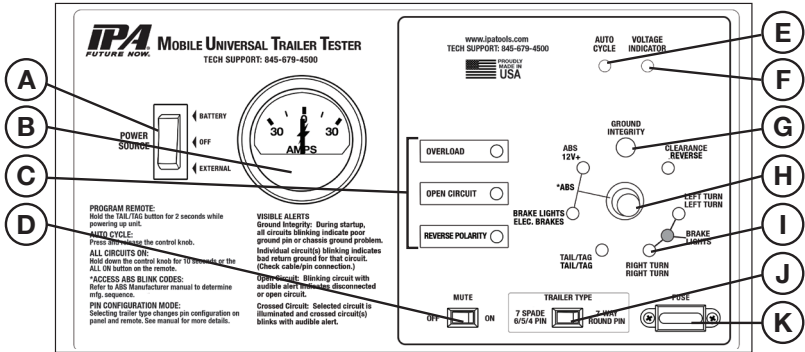

### A. Power Source Switch

Select between Internal Battery, External Power or Power Off.

**Center:** OFF (battery charge in this position only)

**Up:** Installed battery ON

**Down:** External power ON (power supply is an optional accessory)

### B. Backlit 30 Amp Ammeter

Meter shows current draw of a selected circuit up to 30 amps.

### C. Trouble Warning Indicators

Flashing red LEDs indicate problems that may exist in a selected circuit including an overload, open circuit and reversed battery polarity.

### D. Mute Switch

ON disables the sound. OFF enables sound.

### E. Auto Cycle Indicator

Illuminates when Auto Cycle mode is engaged.

### F. Voltage Indicator

Shows supplied battery voltage integrity. Operating voltage range: 12/24 volt DC. Red - charge battery immediately. Amber - charge battery soon. Green - battery voltage within operating range.

### G. Ground Integrity

A large green LED above the control knob indicates ground status. Ground integrity is automatically verified when power is turned on.

### H. Control Knob

Knob activates all electrical test modes and circuits to be diagnosed.

### I. Circuit Indicators

The small green LEDs illuminate or blink in testing phase.

### J. Trailer Type Switch

Selecting a mode changes wiring configuration on panel and remote.

### K. 30 Amp Fuse Socket

Overload protection.

## 5.2 Left and Right Side Panels

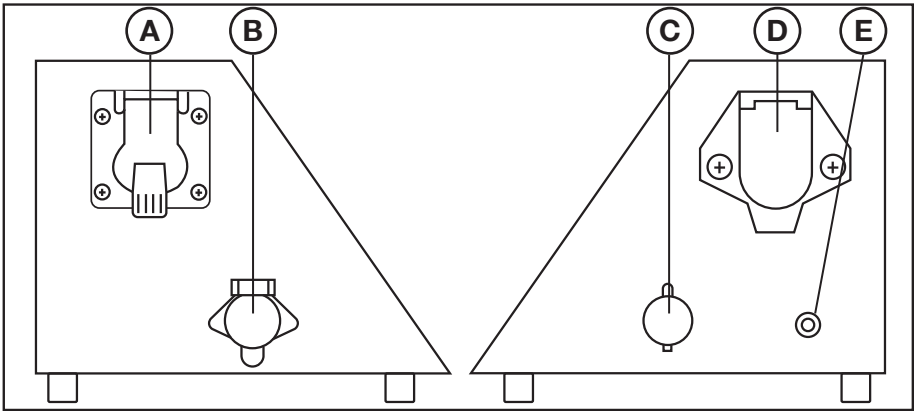

### A. 7-Way Flat (Spade) Pin Socket

Receptacle used to connect your 7-Way Flat (Spade) Pin Trailer to the MUTT® to test electrical circuits.

### B. 20 Amp Independent Power Input Source

For connecting external 12V DC 20 amp max. power supply. (Power supply is an optional accessory, not for battery charging.)

### C. 12V DC Battery Trickle Charger Input

For connecting the charger to the internal lithium ion battery for charging purposes.

### D. 7-Way Round Pin Socket

Receptacle used for connecting your 7-Way Round Pin Trailer to the MUTT® to test electrical circuits.

### E. Chassis Ground Outlet

For connecting a chassis ground cable to the MUTT® when testing trailers using the frame or body for ground connections instead of the ground pin in the harness.

## 5.3 Using the 12-Button Remote Control

The included 12-button remote control is preprogrammed to your SMART MUTT® X and should never lose its programming. In the event that you suspect your remote has lost its programming, contact technical support at 888-786-7899 or email tech247@ipatools.com.

The supplied key fob battery for the remote control is 12V, Alkaline Energizer type A23. A Gold Peak type 23A or Duracell MN21 battery can also be used.

### How to Program the 12-Button Remote

1. Press and hold the TAIL/TAG button while turning the Trailer Tester's main power on.
2. Continue to hold the button for 2 seconds and then release.
3. Your remote control is now programmed.

### How to Use the 12-Button Remote

#### Circuit Selection

Pressing each button will select the corresponding circuit on the MUTT®. Some buttons have different options based on which trailer type you are testing, represented by white and green text. Reference the testers face panel for specific trailer type functions.

(Pressing and holding the ABS/12V+ or Brake Light button will latch both circuits on.)

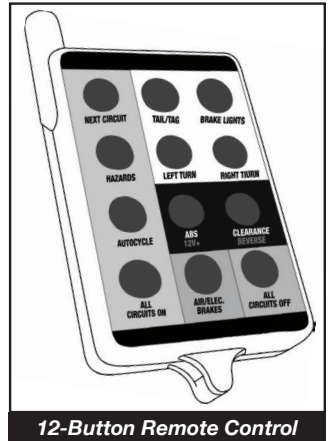

**WARNING:** Inclement weather, nearby power transformers and closely parked trailers may reduce the remote signal.

# PART 6: ELECTRICAL/LIGHTING TESTING

*Complete the pretesting checklist prior to all testing procedures.*

The SMART MUTT® X is microprocessor controlled and features a special diagnostic firmware, designed to speed up your inspection process. The MUTT® will power the selected electrical circuits and instantly alert you to any signs of a faulty condition. **To properly utilize the diagnostic features, a complete scan of the trailer's electrical system should be performed at the front of the trailer using the MUTT® prior to a walk-around inspection.** If any wiring faults are present, the MUTT® will blink or sound, alerting you to the issue. Only a one-time, walk-around/visual inspection is needed to confirm that each individual light bulb is properly illuminating.

**NOTE:** Some advanced functions may not be listed on the face panel, so it's important to read the manual in its entirety to ensure that you are getting the full use of this diagnostic system.

## 6.1 Selecting a Circuit

Circuits can be selected for testing manually, via remote control or by initiating Auto Cycle Mode.

### Manually

1. Turn the control knob to select a circuit. The control knob is automatically set to Ground Integrity when power is turned on.

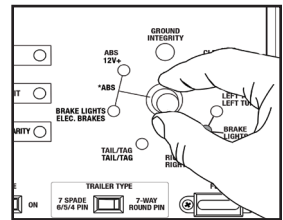

### 12-Button Remote Control

1. Press and release the desired circuit's button.
2. Press the NEXT CIRCUIT button to cycle through circuits.

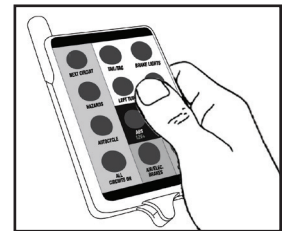

### Auto Cycle Mode

Auto Cycle Mode automatically tests one circuit at a time in a clockwise rotation.

### Manually

1. Press and release the control knob. The Auto Cycle indicator should illuminate.
2. A five-second delay commences between circuit sections.
3. Circuits are automatically tested one at a time in a clockwise rotation.
4. To cancel Auto Cycle mode, momentarily press or turn the control knob.

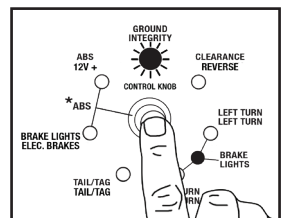

## 12-Button Remote Control

1. Press and release the AUTO CYCLE button on the 12-button remote. The Auto Cycle indicator should illuminate.
2. A five-second delay commences between circuit sections.
3. Circuits are automatically tested one at a time in a clockwise rotation.
4. To cancel Auto Cycle mode, momentarily press or turn the control knob.

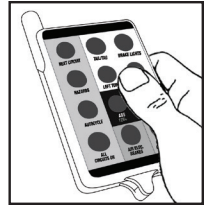

**NOTE:** Auto Cycle mode does not work when ABS or Brake Light Circuits are selected.

## 6.2 Ground Integrity Test

Each time the SMART MUTT® X is powered on, it automatically runs a Ground Integrity Test. A good ground connection must be established for the MUTT® to operate a trailer's electrical system.

1. Immediately after power up, the green lights around the control knob will illuminate.
2. A solid/healthy ground connection is indicated by a steadily illuminated Ground Integrity Indicator.

**NOTE:** The SMART MUTT® X cannot monitor ground condition while selecting circuits. A sudden loss of ground while testing circuits will present as open circuits on each selected circuit. To confirm ground status, turn control knob back to the ground position. While in ground position, the SMART MUTT® X continuously monitors the ground status.

3. Bad/poor ground or bad cable condition is indicated by all of the LEDs blinking simultaneously.
4. When one or more green circuit LEDs blink while the Ground Integrity indicator is steadily illuminated, it indicates that a solid ground has been established, but an open circuit has been detected. Refer to OPEN CIRCUIT on the next page.

## Chassis and Pin Grounds

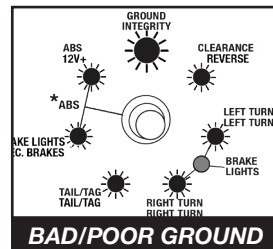
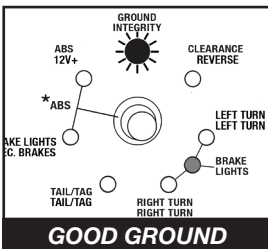

A poor ground warning may be an indication that the connected trailer is only wired for chassis ground. There are two ground types. 1) Pin Ground: The ground wire from each light assembly is wired through the main harness up into the trailer plug. 2) Chassis Ground: The ground wire from each light assembly is grounded directly to the trailer chassis. Ground with the truck is established at the king pin.

**NOTE:** DO NOT assume a bad ground warning is a result of a faulty trailer. Check cable connection.

## Establishing a Chassis Ground

1. To simulate the king pin on a chassis ground connection and bypass the ground integrity fault, plug a chassis ground cable into the MUTT®'s Chassis Ground Outlet.
2. Attach the other end of the chassis ground cable to the chassis of the trailer.
3. Be sure that you are attaching to a clean, dry metal for an effective ground.

### DO NOT

**Assume that a Bad Ground Warning is a Result of a Faulty Trailer. Check Cable Connection.**

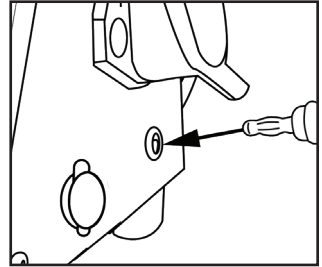

## 6.3 Fault Indication

### Open Circuit

The SMART MUTT® X senses no load which is often the symptom of a disconnected wire, cut wire, poor pin connection or bad return ground. Open circuits can be detected in two ways.

1. During Ground Integrity Test: An individual circuit will blink and no audible alerts will be present.
2. During circuit selection: The selected circuit's LED will blink, while simultaneously the Open Circuit indicator will flash. The MUTT® will also provide an audible alert (beep).

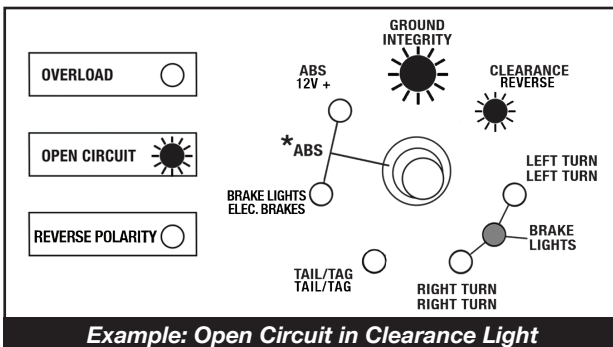

**Example:** The SMART MUTT® X detects an open circuit in the Clearance circuit. The Clearance LED will blink, the Open Circuit indicator will flash and the MUTT® will beep.

**NOTE:** Open Circuit indicator will only illuminate during circuit selection.

## Crossed Circuits

The SMART MUTT® X indicates that two or more circuits are back feeding or crossed. This can be a symptom of two wires in the same harness wearing through their insulated coating and connecting.

1. When a crossed circuit is identified, the selected circuit LED will illuminate steadily and the circuit it is crossed with will flash. The SMART MUTT® X will also provide an audible alert (beep).

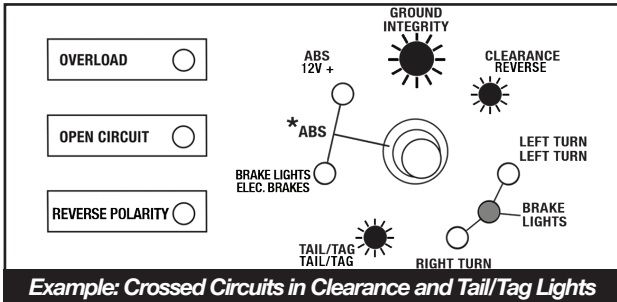

**Example:** The SMART MUTT® X detects that the Clearance and Tail/Tag are crossed while the Clearance circuit is selected. The Clearance LED will illuminate, the Tail/Tag LED will flash and the MUTT® will beep.

**NOTE:** In some cases, a crossed circuit may be a normal function of advanced diagnostic testing, such as with certain ABS systems.

## Short/Overloaded Circuit

Short circuits or overloads can occur when a positive, hot wire touches ground. They can also occur due to faulty lights or connectors.

1. If a short or overloaded circuit is suspected, the SMART MUTT® X will instantly stop powering the circuit.
2. The Overload Warning indicator will then flash, along with the selected circuit's LED. The ammeter needle will also max out and return to 0.
3. The SMART MUTT® X will now automatically enter Pulsar® mode. During Pulsar® mode, the MUTT® will attempt to reapply power to the faulty circuit every three-seconds for an indefinite period of time. After power is applied, if a short is still present, steps 1-3 will automatically repeat.

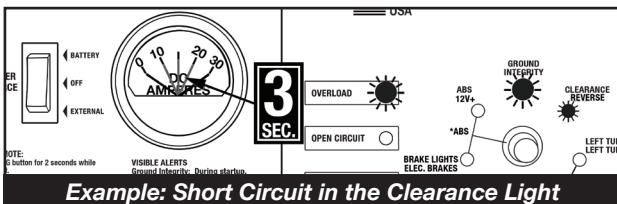

**Example:** The SMART MUTT® X detects a short in the Clearance circuit. The Clearance LED and Overload indicator will flash and a warning beep will sound. The MUTT® will now enter Pulsar® mode.

**NOTE:** PULSAR® mode can be a useful tool for finding dead and intermittent shorts.

## 6.4 Activating Hazard Lights

The four-way flashers on the trailer can be activated with the 12-button remote control.

### 12-Button Remote Control

1. To activate/deactivate, press the HAZARDS button.

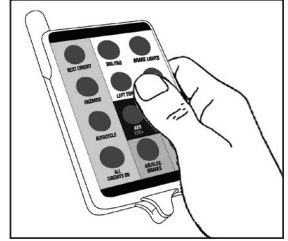

## 6.5 All Circuits On (Override) Mode

All Circuits On mode will engage all electrical circuits at the same time. While short circuit sensing is operational in this mode, if a short circuit is found, the SMART MUTT® X will not be able to identify which circuit is the cause of the short. Open and crossed circuit sensing is not operational in this mode.

On trailers using incandescent bulbs, All Circuits On mode will typically result in an overload because the amperage draw will exceed the maximum of 20 amps.

All Circuits On mode can be accessed manually or by remote control.

### Manually

1. To activate, press and hold the control knob for ten seconds. Listen for beep, then release.
2. To cancel, press or turn the control knob.

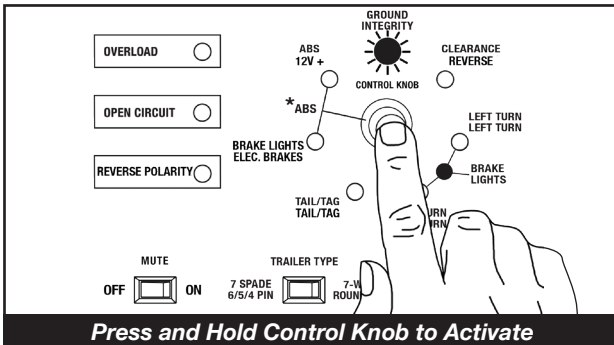

**NOTE:** Does not work when ABS or Brake Light circuits are selected.

### 12-Button Remote Control

1. To activate, press the ALL CIRCUITS ON button. To deactivate, press the ALL CIRCUITS ON button again or press the ALL CIRCUITS OFF button.

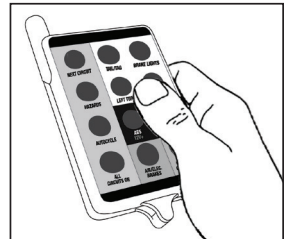

## PART 7: ABS BLINK CODE DIAGNOSTICS

---

The SMART MUTT® X can be used to access ABS Blink Codes on trailers equipped with ABS systems. Trailers equipped with ABS feature an Electronic Control Unit (ECU) which detects any electrical fault in the trailer ABS. Most trailers with ABS will also have a dedicated ABS lamp on the driver side. Each fault has a code. When a fault occurs, the ECU stores the code for that fault in its memory. This fault code will be displayed on the trailer ABS lamp when the proper access sequence is engaged.

### Accessing ABS Blink/Fault Codes

The SMART MUTT® X provides a quick method to trigger ABS blink codes without a tractor present. Depending on the system, you will need to selectively power the Auxiliary and/or Brake Light circuit in the correct order. Instructions on how to access several of the most common ABS systems can be found below.

Once the correct manufacturer's specific sequence is performed, you then must assess the trailer ABS lamp. The number of blinks displayed on the trailer ABS lamp will correspond to a specific ABS fault. As each manufacturer uses different access methods and each blink code has different meanings, the remainder of the ABS section will be broken down by the brand of ABS system installed on the trailer you wish to test.

<p><b>NOTE:</b> ABS Manufacturer Access Protocols/Blink Codes are subject to change. Please consult specific ABS manufacturer manuals for more detailed information and any discrepancies in their literature shall supersede the following directions.</p>
---

## 7.1 Meritor/WABCO Blink Codes

To access Meritor/WABCO blink codes, you must select the Auxiliary circuit to power ON/OFF/ON in one second intervals using the following directions:

1. Make sure trailer is stationary and wheels are properly chocked.
2. On the SMART MUTT® X, turn the control knob to the Auxiliary circuit. Pause one second.
3. Turn the control knob to the Ground Integrity indicator (one position to the right). Pause one second.
4. Turn the control knob back to the Auxiliary circuit (one position to the left).
5. Count the number of blinks on the trailer ABS lamp. Use the chart below for specific fault information.

<b>Blink Code</b>	<b>Problem Area</b>	<b>Action</b>
3	Sensor BUI	Determine sensor location. Check sensor installation. Make necessary repairs.
4	Sensor YE1	Determine sensor location. Check sensor installation. Make necessary repairs.
5	Sensor BU2	Determine sensor location. Check sensor installation. Make necessary repairs.
6	Sensor YE2	Verify proper electrical modulator installation. Check power supply. Make necessary corrections.
7	External ABS Modulator Valve	Verify proper electrical modulator installation. Check power supply. Make necessary corrections.
9	Internal modulator failure inlet valve #2	Verify proper installation. If code continues, contact Meritor/WABCO for assistance.
10	Internal modulator failure inlet valve #1	Verify proper installation. If code continues, contact Meritor/WABCO for assistance.
11	Internal modulator failure inlet valve	Verify proper installation. If code continues, contact Meritor/WABCO for assistance.
14	Power Supply	Verify proper electrical installation. Check power supply. Make necessary corrections.
15	ECU Failure	Verify proper installation. If code continues, contact Meritor/WABCO for assistance.
16	SAE J1 708 Failure	Internal failure, contact Meritor/WABCO.
17	SAE J2497 (PLC) Failure	Internal failure, contact Meritor/WABCO.
18	Generic I/O Failure	Verify proper electrical installation. Check power supply. Make necessary corrections.

*For diagnostic and troubleshooting assistance, call Meritor WABCO at 1-800-535-5560.*

## 7.2 Haldex Blink Codes

To access Haldex Blink Codes, you must select the Brake Light circuit and press the control knob to cycle the Auxiliary circuit the appropriate number of times using the following directions:

See table below for modes and sequences:

Mode	Description	Ignition Cycles (Hold 1 Second ON/OFF)
1	Simple/Wheel Speed Mode	ON, off, ON
2	Active Faults Mode	ON, off, ON, off, ON
3	Stored Faults/Clear Mode	ON, off, ON, off, ON, off, ON
4	Configuration Mode	ON, off, ON, off, ON, off, ON, off, ON

1. Make sure trailer is stationary and wheels are properly chocked.
2. On the SMART MUTT® X, turn the control knob to select Brake Light circuit.
3. Push the control knob to cycle Auxiliary circuit ON for each desired ignition cycle. Auxiliary circuit will flash.
4. Each Ignition Cycle must end with both Brake Light and Auxiliary circuits simultaneously powered. To do this, press and hold the control knob for five seconds during the last ON cycle.
5. Count the number of blinks on trailer ABS lamp; see the following charts (pg. 18-22) for specific fault info.

Item	Flash Count	Actual Fault
System OK	Light Stays On	07
Sensor 1A	1 Flash	01
Sensor 1B	2 Flashes	02
Sensor 2A	3 Flashes	03
Sensor 2B	4 Flashes	04
Sensor 3A	5 Flashes	05
Sensor 3B	6 Flashes	06
Red Valve	7 Flashes	61, 67, 71, 77, 81, & 87
Blue Valve	8 Flashes	62, 68, 72, 78, 82, & 88
Yellow Valve	9 Flashes	63, 69, 73, 79, 83, & 89
Low Voltage	10 Flashes	90
ECU Failure	11 Flashes	93, 99, & E-Codes

<b>Fault Code</b>	<b>Explanation</b>	<b>Possible Causes</b>	<b>PLC Select 1M</b>	<b>PLC Select 2M</b>
00	System OK (with vehicle traveling > 6 mph).	ABS is operational. Displays "00" when traveling > 6 mph.	X	X
01	Red channel wheel speed sensor wiring S1A has an open or short circuit.	Indicates a wheel speed sensor or its wiring has short or open circuit. Disconnect the relevant sensor and measure the resistance between the two pins in the sensor connector housing. If sensor extensions are used, verify extension continuity and connections. Replace sensor and/or extension cable. The Ohm meter reading for the sensor or sensor and extension cable should be between 980 and 2350 Ohm (.98K and 2.35K Ohm) If not, replace sensor and/or extension cable.	X	
02	Red channel wheel speed sensor wiring S1B has an open or short circuit.		X	
03	Blue channel wheel speed sensor wiring S2A has an open or short circuit.			X
04	Yellow channel wheel speed sensor wiring S2B has an open or short circuit.			X
05	Blue channel wheel speed sensor wiring S3A has an open or short circuit.			X
06	Yellow channel wheel speed sensor wiring S3B has an open or short circuit.			X
07	System OK (No Active Fault).	ABS ECU is fully operational. Displays "07" when vehicle is stationary.	X	X
11	Red channel speed sensor S1A has low sensor output.	Sensor or spring clip is worn or not properly adjusted, wiring open or short circuit, wheel bearing not properly adjusted (these faults will only occur at speeds > 6 mph). Measure the AC voltage at the sensor in question while rotating the wheel at a rate of about one revolution every two seconds. The output should be at least 200 millivolts (0.2V AC). If this is not the case, push in the sensor until it touches the exciter and rotate the wheel again. If this doesn't correct the problem, then the sensor and the sensor block clip should be replaced. If sensor extensions are used, verify extension continuity and connections. Replace sensor and/or sensor cable. Inspect exciter teeth for minor damage or teeth filled with debris. Verify all exciters have the same number of teeth. Verify sensor and valve wiring/plumbing is correct. See Side-by-Side and Axle-by-Axle configurations.	X	
12	Red channel speed sensor S1B has low sensor output.		X	
13	Blue channel speed sensor S2A has low sensor output.			X
14	Yellow channel speed sensor S2B has low sensor output.			X
15	Blue channel speed sensor S3A has low sensor output.			X
16	Yellow channel speed sensor S3B gap too large. Gap should be kept to a minimum.			X

Fault Code	Explanation	Possible Causes	PLC Select 1M	PLC Select 2M
21	Red channel wheel speed sensor S1A has an erratic output voltage.	Loose sensor, connection, bracket or exciter, damaged exciter, sensor is not properly adjusted or has worn cable insulation, or worn sensor block clip, wheel bearing failure, wheel bearing is not properly adjusted ( <b>these faults will only occur at speeds &gt; 6 mph</b> ).	X	
22	Red channel wheel speed sensor S1B has an erratic output voltage.	Measure the AC voltage at the sensor in question while rotating the wheel at a rate of about one rotation every two seconds. The output should be at least 200 millivolts (0.2V AC).	X	
23	Blue channel wheel speed sensor S2A has an erratic output voltage.	If this is not the case, push in the sensor until it touches the exciter and rotate the wheel again. If this doesn't correct the problem, then the sensor should be replaced.		X
24	Yellow channel wheel speed sensor S2B has an erratic output voltage.	Verify the tire and wheel size is large enough for 100 tooth exciter ring. If these faults re-occur at the same speed, inspect the exciter ring for damage.		X
25	Blue channel wheel speed sensor S3A has an erratic output voltage.	Smaller wheels and tires require 80 tooth exciter rings. Reference Tire Scale Factor Chart.		X
26	Yellow channel wheel speed sensor S3B has an erratic output voltage.	Verify sensor and valve wiring/plumbing is correct. See Side-by-Side and Axle-by-Axle configurations.		X

### Occurs Only When Vehicle is Stationary

31	Auxiliary channel 1 fault (digital channel 1) output only.	PLC Select 2M Plus (ABS Auxiliary Codes).		
32	Auxiliary channel 2 fault (digital channel 2) output only.	Note: These codes are only used with PLC select 2M Plus ABS that supports trailer auxiliaries.		
33	Auxiliary channel 3 fault (digital channel 3) output only.	Auxiliary Channel has an open circuit or the ECU (Electronic Control Unit) has an auxiliary device connected and is not programmed to be.		
34	Auxiliary channel 4 fault (digital channel 4) output only.	Note: These codes do not affect ABS performance and do not illuminate the tractor trailer ABS warning lamps.		
35	Auxiliary channel 5 fault (digital channel 3) output only.			

<b>Fault Code</b>	<b>Explanation</b>	<b>Possible Causes</b>	<b>PLC Select 1M</b>	<b>PLC Select 2M</b>	
41	Slow wheel recovery on Red valve channel.	For a 2M System, verify sensor and valve wiring/plumbing is correct. (See Side-By-Side and Axle-By-Axle configurations). Slow brake release, foundation brake mechanical faults, dry bushings, broken ABS valve, restricted piping. Check for kinks and blockage etc., incorrect air-lines, wiring.	X		
42	Slow wheel recovery on Blue valve channel.			X	
43	Slow wheel recovery on Yellow valve channel.			X	
61	Hold solenoid open circuit on Red valve channel.	Modulator valve solenoid failure, solenoid connection, or valve cable damage. The most likely causes include: a bad solenoid or a loose solenoid connection. Disconnect the indicated solenoid and check the resistance at the solenoid pins.	X		
62	Hold solenoid open circuit on Blue valve channel.			X	
63	Hold solenoid open circuit on Yellow valve channel.			X	
67	Dump solenoid open circuit on Red valve channel.		Check the female terminals on the connector for excessive pin spread or corrosion. Replace defective hardware as required and retest.	X	
68	Dump solenoid open circuit on Blue valve channel.				X
69	Dump solenoid open circuit on Yellow valve channel.			X	
71	Hold solenoid short circuit to ground on Red valve channel.	Modulator valve solenoid failure, or valve cable damage. The most likely causes include: a damaged cable or solenoid. An example of this is a worn or chafed cable that has exposed wires contacting the trailer.  Disconnect the indicated solenoid and check the resistance at the solenoid pins.	X		
72	Hold solenoid short circuit to ground on Blue valve channel.			X	
73	Hold solenoid short circuit to ground on Yellow valve channel.			X	
77	Dump solenoid short circuit to ground on Red valve channel.			X	
78	Dump solenoid short circuit to ground on Blue valve channel.			X	
79	Dump solenoid short circuit to ground on Yellow valve channel.			X	

<b>Fault Code</b>	<b>Explanation</b>	<b>Possible Causes</b>	<b>PLC Select 1M</b>	<b>PLC Select 2M</b>	
80	Output leakage or poor insulation on any of the valve channels.	Modulator valve solenoid failure or valve cable damage. Indicates that the solenoid or its cable has a short circuit to positive power (12 volts DC). The most likely cause is a damaged cable or solenoid. Disconnect the indicated solenoid and check the resistance at the solenoid pins.  If solenoid checks good and 80-89 code still exists, check ECU.	X	X	
81	Hold solenoid short circuit to permanent power on Red valve channel.		X		
82	Hold solenoid short circuit to permanent power on Blue valve channel.			X	
83	Hold solenoid short circuit to permanent power on Yellow valve channel.			X	
87	Dump solenoid out shorted to permanent power on Red valve channel.		X		
88	Dump solenoid out shorted to permanent power on Blue valve channel.			X	
89	Dump solenoid out shorted to Permanent Power on Yellow valve channel.			X	
90	Low supply voltage fault. This code is not stored in memory.		Verify 12V DC power source. Do Not Use battery charger as power supply. ECU minimum operating voltage is 8.5V DC.	X	X
91	No internal ABS ECU solenoid voltage available.		Verify permanent power is present.	X	X
92	Power input over voltage fault.	Verify 12V DC power source. Do Not Use battery charger as power supply. ECU maximum operating voltage is 16.0V DC.	X	X	
93	Short circuit on ABS ECU internal relay.	Replace ECU.	X	X	
99	ABS corrupt memory.		X	X	
9A	ABS corrupt memory.		X		

### 7.3 Bendix Blink Codes

To access Bendix Blink Codes you must select the Auxiliary circuit and press the control knob to cycle the Brake Light circuit the appropriate number of times using the following directions:

See table below for modes and sequences:

Mode	Cycle Brake Light Power
Display Active DTCs	3 times
Display Inactive DTCs	4 times
Clear Active DTCs	5 times
Display Configuration	6 times
Display Odometer Mileage	7 times
Reset Configuration	8 times

1. Make sure trailer is stationary and wheels are properly chocked.
2. On the SMART MUTT® X, turn the control knob to select the Auxiliary circuit
3. Push the control knob to cycle the Brake Light circuit for each desired cycle in one second intervals. The Brake Light circuit will flash.
4. Count the number of blinks on the Trailer ABS lamp; see the following charts (pg. 23-25) for specific fault info.

**NOTE:** Blink code “digits” are separated by a one second pause.

1st Digit	2nd Digit	Fault Description	Repair Information	J1587 (SID)	J1587 (FMI)
10	10	No Faults	ABS system fully operational - no faults detected.	1	0

### Wheel Speed Sensors (WSS)

2	1	SL Sensor signal valid -large gap	Dynamic Wheel Speed Sensor Fault.	1	0
3	1	SR Sensor signal valid - large air gap		2	0
4	1	SAL Sensor signal valid - large air gap		3	0
5	1	SAR Sensor signal valid - large air gap		4	0
2	2	SL Sensor signal valid - loss of signal		1	1
3	2	SR Sensor signal valid - loss of signal		2	1
4	2	SAL Sensor signal valid - loss of signal		3	1
5	2	SAR Sensor signal valid - loss of signal		4	1
2	3	SL Sensor signal valid – noisy		1	2
3	3	SR Sensor signal valid – noisy		2	2
4	3	SAL Sensor signal valid – noisy	3	2	
5	3	SAR Sensor signal valid – noisy	4	2	
2	4	SL Sensor shorted or open	Static Wheel Speed Sensor Fault.	1	4 or 5
3	4	SR Sensor shorted or open		2	4 or 5
4	4	SAL Sensor shorted or open		3	4 or 5
5	4	SAR Sensor shorted or open		4	4 or 5
2	5	SL Tire diameter out of range	Verify correct tire size as desired. Verify proper tire inflation. Verify correct number of exciting teeth. Verify that the ECU has the proper tire size settings.	1	13
3	5	SR Tire diameter out of range		2	13
4	5	SAL Tire diameter out of range		3	13
5	5	SAR Tire diameter out of range		4	13

4	6	SAL Sensor configuration error	Verify correct ABS configuration using blink codes or other diagnostic tools. If needed, reset to the default ABS configuration and power-up to initiate auto-configuration.	3	13
5	6	SAR Sensor configuration error		4	13

### Power

6	1	Over-voltage	Power supply diagnostic trouble code.	251	3
6	2	Low-voltage	Power supply diagnostic trouble code.	251	4
6	3	Excessive power line resistance	Power supply diagnostic trouble code.	251	13

### Modulator (MOD)

7	1	MOD1 Hold solenoid shorted or open	Clear faults. If faults return, replace the TABS-6 Module.	42	3,4,5 6 or 12
7	2	MOD1 Release solenoid shorted or open		48	3,4,5 6 or 12
8	1	MOD2 Hold solenoid shorted or open	Static ABS Modulator Fault.	43	3,4,5 6 or 12
9	1	MOD3 Hold solenoid shorted or open		44	3,4,5 6 or 12
8	2	MOD2 Releasesolenoidshortedoropen		49	3,4,5 6 or 12
9	2	MOD3 Release solenoid shorted or open		50	3,4,5 6 or 12
7	3	MOD1 ABS modulator dynamic error	Dynamic ABS Modulator Fault.	7	7
8	3	MOD2 ABS modulator dynamic error		8	7
9	3	MOD3 ABS modulator dynamic error		9	7
8	4	MOD2 Valve configuration error	Verify correct ABS configuration using blink codes or other diagnostic tools. If needed, reset to the default ABS configuration and power-up to initiate auto-configuration.	8	13
9	4	MOD3 Valve configuration error		9	13

### Common

10	1	Valve MOD1/2 low-side switch shorted to ground	Check for corroded/damaged wiring or connectors between the ECU and MOD. At the MOD harness connector, verify: No continuity from modulator/AUX leads to ground. After repairs or if no issues found, then clear faults. If faults return, replace the TABS-6 Module.	7	4
10	2	Valve MOD3 low-side switch shorted to ground		9	4
10	3	ABS modulator dynamic error - all valves	Dynamic ABS Modulator Fault.	7	7
10	4	Excessive ABS activity	Dynamic Wheel Speed Sensor Fault.	1	7

## Electronic Control Unit (ECU)

11	1	ECU internal error	Check for damaged or corroded connectors. Check for damaged wiring. After repairs or if no issues found, then clear faults. If faults return, replace the TABS-6 Module.	254	12
11	2	ECU configuration error	Verify correct ABS configuration using blink codes, PC-diagnostics or other off-board diagnostic tools. If needed, reset to the default ABS configuration and power-up to initiate auto-configuration.	254	13

## J1587 Diagnostic

12	1	J1587	<p>Check for corroded/damaged wiring or connectors between the ECU and J1587 Diagnostic. Verify the following:</p> <p>-At the 18-pin ECU harness connector:</p> <p style="margin-left: 20px;">(a) Continuity of the J1587 Diagnostic wiring to the lamp (auxiliary device).</p> <p style="margin-left: 20px;">(b) +12V is not measured at J1587 Diagnostic lead.</p> <p>-At J1587 Diagnostic connector:</p> <p style="margin-left: 20px;">(a) No continuity of the J1587 Diagnostic lead to ground.</p> <p style="margin-left: 20px;">(b) No continuity from J1587 Diagnostic lead to any other ECU pin(s).</p> <p style="margin-left: 20px;">(c) Replace or repair J1587 Diagnostic wiring or components as required.</p>	250	3,4,5 or 12
----	---	-------	--	-----	----------------

## Trailer-Mounted ABS Indicator Lamp

13	1	ABS lamp shorted or open	<p>Check for corroded/damaged wiring or connectors between the ECU and ABS Indicator Lamp. Verify the following:</p> <p>-At the 5-pin or 18-pin ECU harness connector:</p> <p style="margin-left: 20px;">(a) Continuity of the ABS Indicator Lamp wiring to the lamp auxiliary device).</p> <p style="margin-left: 20px;">(b) +12V is not measured at ABS Indicator Lamp lead to any other ECU pin(s).</p> <p>-At ABS Indicator Lamp connector:</p> <p style="margin-left: 20px;">(a) No continuity of the ABS Indicator Lamp lead to ground.</p> <p style="margin-left: 20px;">(b) No continuity from ABS Indicator Lamp lead to any other ECU pin(s).</p> <p style="margin-left: 20px;">(c) Replace/repair ABS Indicator Lamp wiring or components as required.</p>	81	3,4,5 or 12
----	---	--------------------------	---	----	----------------

## PART 8: MAINTENANCE

---

### 8.1 Maintenance and Storage

- Switch power to OFF and remove all power cables before storing and cleaning.
- Wipe surfaces down with a well-wrung, soft, damp cloth.
- Diluted dishwasher liquid or similar substance can be used in the dampened cloth if necessary.
- Frequently clean and resize the 7-way pin connectors and add dielectric grease to the 7-way pin connector outlet. This will ensure a proper connection when using your SMART MUTT® X.
- Do not allow water to enter the control panel.
- Store in a cool, dry area when not in use and keep covered to prevent dust from accumulating inside the unit.
- Do not store in direct sunlight.
- Do not store near magnetic field or damage to the microprocessor may occur.

## 8.2 Instructions for In- and Out-of-Warranty Repairs

If you experience any difficulty with your SMART MUTT® X, please call IPA® toll free at 888-786-7899 and speak to one of our tech-support representative to determine if the tester should be returned for repair. Our return and service policies are designed to be simple and hassle free. Please follow the instructions listed in this manual when you feel you have a product that is in need of repair. If at any point in the process you are not happy with the service or support you receive from any member of the IPA® team, please email [president@ipatools.com](mailto:president@ipatools.com).

### Step 1: Determine Type of Repair Needed

There are three types of repair:

Physically Broken – Tester has physical damage, i.e. switch snapped off, socket came loose, etc.

Erratic Behavior – Tester is not working properly, i.e. lights flashing, erroneous error warnings, etc.

Problems with Components/Accessories – Issues with items not in the main tester, i.e. remotes not programming, battery charger issues, etc.

### Step 2: Determining Service Action

Many issues can be fixed over the phone with the help of one of our tech-support team members. If you have an issue with one of our testers, call 888-786-7899 or email [tech@ipatools.com](mailto:tech@ipatools.com) to speak with one of our team members. They will determine the best level of service to provide for the tester.

There are three levels of repair:

Fix Over the Phone – Tech support will walk the customer through the repair over the phone. No parts or in-house service is needed.

Field Repair – Tech support will send the required parts needed for the customer to service the tester in the field themselves.

In-house Repair – The customer will send in the tester for the tech-support team to service in house.

### Step 3: Acquire RGA #

Once a tech-support team member determines the tester needs to be sent in for repair, an RGA # will be assigned along with next step instructions for the customer.

#### Note:

- Always take at least 5 pictures of your tester BEFORE sending the tester to the IPA® facility.
- IPA® is not liable for any damage that occurs to the tester during shipment.
- Consult a tech-support team member over the phone or via email before you send in any tester for repair. Testers with excessive sheet metal damage may not be eligible for repair and a tech may suggest another option, i.e. swap-out program, scratch and dent model.



\*\* Examples of situations and parts not covered by out-of-warranty service: punctured tires, dented sheet metal, standard misuse and abuse, worn-out connectors due to excessive use, water/fire damage.

# PART 9: TROUBLESHOOTING

---

## 9.1 FAQ

- NEVER assume a connection is a quality connection. Many ABS issues are the direct result of poor pin or sensor connections. These poor connections can be located directly at the ABS ECU on the trailer and typically can be found at the 7-way round nose box connection. If you suspect poor connectivity problems, verify the 7-way cable is securely inserted into the 7-way connection. Make sure the cable head is bottomed out in the connector. Always be certain to check the 7 pins in each plug are clean and spread to proper size before using.

## 9.2 Common System Checks

There are many safety and operational functions to test on a trailer. With the SMART MUTT<sup>®</sup> X, these tests can be performed without the truck or tractor, quickly, accurately, and in most cases, with only one person. Below are a few common system checks that can be performed using the SMART MUTT<sup>®</sup> X.

- One-man shake testing throughout the trailer.
- Even electric brake pressure activation.
- One-man, wheel-off-ground testing for brake strength and operation.

### 9.3 Common Troubleshooting Solutions

Symptom	Possible Cause	Solution
30-amp fuse keeps blowing.	Shorted cig. socket or power connector.	Remove wires going to cig. socket. If fuse still blows, call tech support at 888-786-7899
Open Circuit Warning.	Poor pin connections.	Spread and grease pins
	Trailer circuit is disconnected.	Check trailer wiring.
	Current draw from trailer is too low or nonexistent.	Make sure trailer lights are connected.
Short/Overload Warning: System goes into overload or short circuit protection if more than 21 amps of current draw at 12V is detected for longer than 69 milliseconds.	Short circuit condition is detected if the overdraw > 50 amps in less than 69 milliseconds. Short is defined by positive power connected directly to ground.	Remove cause of short and retest.
	Overload is determined if overdraw > 21 amps but < 50 amps in 69 milliseconds.	

**Note:** For more troubleshooting help, please call 888-786-7899 or email [tech247@ipatools.com](mailto:tech247@ipatools.com).

# PART 10: TYPICAL TRAILER WIRING

**Note:** Not all trailers/vehicles are wired to this standard. The use of an electrical circuit tester is necessary to ensure proper match of vehicle's wiring to trailer's wiring. On some trailers with 6-way round plugs, the 12V wire and electric brake wire may be reversed (particularly horse trailers).

## Trailer Wiring (View From Front Plug)

### 6-WAY ROUND PIN PLUG

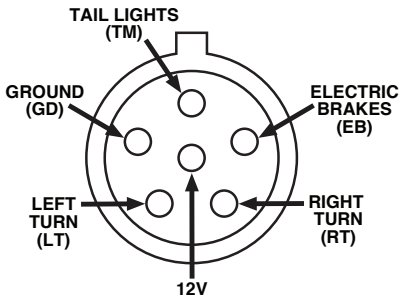

### 7-WAY ROUND PIN PLUG

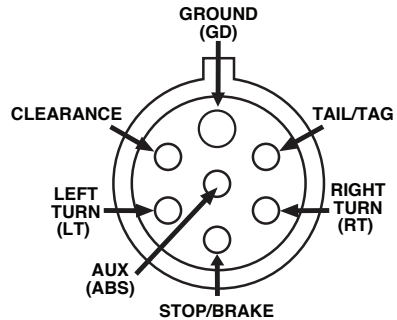

### 7-WAY FLAT PIN PLUG

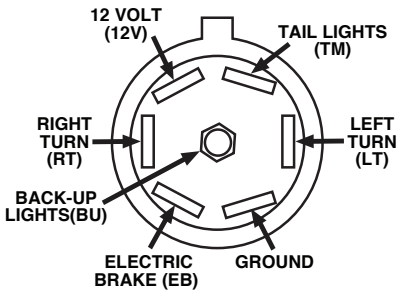

### 4/5 PIN PLUG

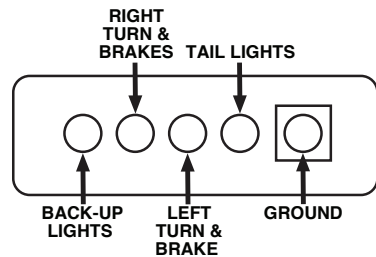

# PART 11: OPTIONAL ACCESSORIES AND RELATED PRODUCTS

**#9008-DL SUPER MUTT® PRO EDITION:** (2) 12-Button Remote Controls, 5-ft. 7-Way Cable, 8-ft. Gladhands, 10A Smart Battery Charger, Face/Battery Shield and Rain Cover

**#5611A-RT8 ALPHA MUTT® (2<sup>ND</sup> GEN) w/ ABS, RUGGED TABLET, & SLIDE-OUT BASE (Service-Truck Model):** Rugged Tablet, 12-Button Remote Control, 20-ft. 7-Way Cable, 20-ft. Gladhands with Handles, Bluetooth® Antenna, 5-ft. Bluetooth® Extension Cable and Power Cable

**#5710A-T10 ALPHA MUTT® (2<sup>ND</sup> GEN) w/ ABS (Shop Model):** Tablet, 12-Button Remote Control, 12-ft. 7-Way Cable, 12-ft. Gladhands with Handles, Bluetooth® Antenna, 12-in. Bluetooth® Extension Cable, External Battery Connectors and Rain Cover



#9008-DL



#5611A-RT8



#5710A-T10

**#8026 4/5 PIN TOWING MAINTENANCE KIT**



**#7866 4/5 PIN TRAILER HARNESS CHECKER**



**#8027 6-WAY ROUND PIN TOWING MAINTENANCE KIT**



**#7897 6-WAY ROUND PIN TRACTOR TRAILER CIRCUIT TESTER**



**#8028 7-WAY FLAT (SPADE) PIN TOWING MAINTENANCE KIT**



**#7893 7-WAY FLAT (SPADE) PIN TRAILER CIRCUIT TESTER**



**#8029 7-WAY ROUND PIN TOWING MAINTENANCE KIT**



**#7865L 7-WAY ROUND PIN TRACTOR TRAILER CIRCUIT TESTER**



**#8000 3-WAY TRAILER ADAPTER**



**#TSTPK1 MULTI-TRAILER TESTER JOBBER PACK**



# Limited Three-Year Warranty

## #4105/#4105-L4 SMART MUTT® X

### Mobile Universal Trailer Tester

---

Innovative Products of America® Incorporated has established a Limited Three-Year Warranty Policy for the SMART MUTT® X Series, not including any wearable parts, i.e. cables, battery clips, etc.

**Three-Year Limited Warranty/Return or Replace Policy:** The product is covered for three years from the date of original user purchase under the stipulations of the standard warranty.

The product is warranted to be free from defects in workmanship or material. If there is a problem due to workmanship or material defect, Innovative Products of America® Incorporated will repair or replace the product within 24-working hours after it is received by the IPA® repair service center. In the event it is determined that the product has been tampered with, or altered in any way, the warranty is void and all claims against the product will not be honored. The warranty repair/return procedures require that the proof of purchase must be established (either by warranty card from the seller or by point of purchase receipt/invoice) and the manufacturer makes every attempt to return ship the product within three business days from the receipt of the returned product, freight prepaid.

If it has been determined that the tool has been damaged due to misuse, Innovative Products of America® Incorporated will repair the tool at a cost we deem reasonable and these charges will be the responsibility of the user. We truly want you to be happy with our products, so if you have any questions, call us toll-free at 888-786-7899.



**Innovative Products of America® Incorporated**  
234 Tinker Street, Woodstock, NY 12498  
888-786-7899 • 845-679-4500 • [www.ipatools.com](http://www.ipatools.com)