

AIRPLUS

**PORTABLE AIR
CONDITIONER
USER MANUAL**

AIRPLUS



Customer Service Email

us.airplus@gmail.com

s.frankie@aboutkehome.com

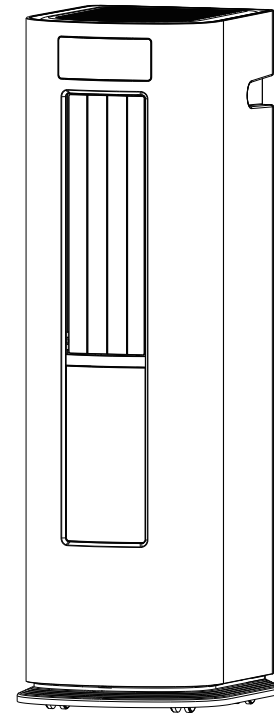

KY- 17D1

CONTACT US

We guarantee a replacement or a full refund to you if you have any problems with your dehumidifier in the future! Please keep this manual for future reference.



Customer Service Email

us.airplus@gmail.com

s.frankie@aoutkehome.com

ATTENTION

Contact us to get **A FULL REFUND** or **A REPLACEMENT** if you have any problems with this product.

CONTENTS

Use Environment	01
Safety Instructions	01
Product Specifications	07
Name Of Each Part	08
Control panel	09
Remote control	09
Operation	10
Other functions	12
Preparation for using remote control	12
Precautions for using remote control	13
Cleaning and maintenance	13
Installation precautions	15
Preparation before installation	16
Drainage method	17
Installation and removal of heat discharge pipe	18
Precautions for installing heat discharge pipe	19
Install window isolation panels	20
Troubleshooting	22

USE ENVIRONMENT

- This air conditioner is suitable for temperature range of 50-95°F
- This air conditioner is only suitable for family rooms and is not suitable for commercial or industrial purposes.
- At least 50cm of space should be reserved in front of and behind the air conditioner.
- Avoid using in damp environments; Avoid direct sunlight.
- Please keep the air inlet and outlet clean and free of obstacles.
- Please close the doors and windows when using to improve the cooling/heating effect.
- To avoid abnormal situations such as noise and vibration of the air conditioner, please place the air conditioner on a flat ground.
- This air conditioner comes with casters for easy sliding. The casters should slide on a smooth and flat surface, not on carpets or surfaces with obstacles, to avoid dirt on the ground wrapping around the casters and making sliding inconvenient.
- Do not tilt or lie down the air conditioner. If there is any abnormality, immediately turn off the power and contact the dealer for inspection and repair

SAFETY INSTRUCTIONS

Do not use means to accelerate the defrosting process or to clean, other than those recommended by the manufacturer.
The appliance shall be stored in a room without continuously operating ignition sources (for example: open flames, an operating gas appliance or an operating electric heater.
Do not pierce or burn.
Be aware that refrigerants may not contain an odour.



Refer operators manual



Read technical manual



Read operators

Qualification of workers

Every working procedure that affects safety means shall only be carried out by competent persons.

Examples for such working procedures are:

- breaking into the refrigerating circuit;
- opening of sealed components;
- opening of ventilated enclosures.

Checks to the area

Prior to beginning work on systems containing FLAMMABLE REFRIGERANTS, safety checks are necessary to ensure that the risk of ignition is minimised.

Work procedure

Work shall be undertaken under a controlled procedure so as to minimise the risk of a flammable gas or vapour being present while the work is being performed.

General work area

All maintenance staff and others working in the local area shall be instructed on the nature of work being carried out. Work in confined spaces shall be avoided.

Checking for presence of refrigerant

The area shall be checked with an appropriate refrigerant detector prior to and during work, to ensure the technician is aware of potentially toxic or flammable atmospheres. Ensure that the leak detection equipment being used is suitable for use with all applicable refrigerants, i.e. non-sparking, adequately sealed or intrinsically safe.

Presence of fire extinguisher

If any hot work is to be conducted on the refrigerating equipment or any associated parts, appropriate fire extinguishing equipment shall be available to hand. Have a dry powder or CO2 fire extinguisher adjacent to the charging area.

No ignition sources

No person carrying out work in relation to a REFRIGERATING SYSTEM which involves exposing any pipe work shall use any sources of ignition in such a manner that it may lead to the risk of fire or explosion. All possible ignition sources, including cigarette smoking, should be kept sufficiently far away from the site of installation, repairing, removing and disposal, during which refrigerant can possibly be released to the surrounding space. Prior to work taking place, the area around the equipment is to be surveyed to make sure that there are no flammable hazards or ignition risks. "No Smoking" signs shall be displayed.

Ventilated area

Ensure that the area is in the open or that it is adequately ventilated before breaking into the system or conducting any hot work. A degree of ventilation shall continue during the period that the work is carried out. The ventilation should safely disperse any released refrigerant and preferably expel it externally into the atmosphere.

Checks to the refrigerating equipment

Where electrical components are being changed, they shall be fit for the purpose and to the correct specification. At all times the manufacturer's maintenance and service guidelines shall be followed. If in doubt, consult the manufacturer's technical department for assistance.

The following checks shall be applied to installations using FLAMMABLE REFRIGERANTS:

- the actual REFRIGERANT CHARGE is in accordance with the room size within which the refrigerant containing parts are installed;

- the ventilation machinery and outlets are operating adequately and are not obstructed;
- if an indirect refrigerating circuit is being used, the secondary circuit shall be checked for the presence of refrigerant;
- marking to the equipment continues to be visible and legible. Markings and signs that are illegible shall be corrected;
- refrigerating pipe or components are installed in a position where they are unlikely to be exposed to any substance which may corrode refrigerant containing components, unless the components are constructed of materials which are inherently resistant to being corroded or are suitably protected against being so corroded.

Checks to the refrigerating equipment

Where electrical components are being changed, they shall be fit for the purpose and to the correct specification. At all times the manufacturer's maintenance and service guidelines shall be followed. If in doubt, consult the manufacturer's technical department for assistance.

The following checks shall be applied to installations using FLAMMABLE REFRIGERANTS:

- the actual REFRIGERANT CHARGE is in accordance with the room size within which the refrigerant containing parts are installed;
- the ventilation machinery and outlets are operating adequately and are not obstructed;
- if an indirect refrigerating circuit is being used, the secondary circuit shall be checked for the presence of refrigerant;
- marking to the equipment continues to be visible and legible. Markings and signs that are illegible shall be corrected;
- refrigerating pipe or components are installed in a position where they are unlikely to be exposed to any substance which may corrode refrigerant containing components, unless the components are constructed of materials which are inherently resistant to being corroded or are suitably protected against being so corroded.

Checks to electrical devices

Repair and maintenance to electrical components shall include initial safety checks and component inspection procedures. If a fault exists that could compromise safety, then no electrical supply shall be connected to the circuit until it is satisfactorily dealt with. If the fault cannot be corrected immediately but it is necessary to continue operation, an adequate temporary solution shall be used. This shall be reported to the owner of the equipment so all parties are advised.

Initial safety checks shall include:

- that capacitors are discharged: this shall be done in a safe manner to avoid possibility of sparking;
- that no live electrical components and wiring are exposed while charging, recovering or purging the system;
- that there is continuity of earth bonding.

Repairs to sealed components

Sealed electrical components shall be replaced.

Cabling

Check that cabling will not be subject to wear, corrosion, excessive pressure, vibration, sharp edges or any other adverse environmental effects. The check

shall also take into account the effects of aging or continual vibration from sources such as compressors or fans.

Detection of flammable refrigerants

Under no circumstances shall potential sources of ignition be used in the searching for or detection of refrigerant leaks. A halide torch (or any other detector using a naked flame) shall not be used.

The following leak detection methods are deemed acceptable for all refrigerant systems.

Electronic leak detectors may be used to detect refrigerant leaks but, in the case of FLAMMABLE REFRIGERANTS, the sensitivity may not be adequate, or may need re-calibration. (Detection equipment shall be calibrated in a refrigerant-free area.) Ensure that the detector is not a potential source of ignition and is suitable for the refrigerant used. Leak detection equipment shall be set at a percentage of the LFL of the refrigerant and shall be calibrated to the refrigerant employed, and the appropriate percentage of gas (25 % maximum) is confirmed.

Leak detection fluids are also suitable for use with most refrigerants but the use of detergents containing chlorine shall be avoided as the chlorine may react with the refrigerant and corrode the copper pipe-work.

If a leak is suspected, all naked flames shall be removed/extinguished.

If a leakage of refrigerant is found which requires brazing, all of the refrigerant shall be recovered from the system, or isolated (by means of shut off valves) in a part of the system remote from the leak. Removal of refrigerant shall be according to Removal and evacuation.

Removal and evacuation

When breaking into the refrigerant circuit to make repairs – or for any other purpose – conventional procedures shall be used. However, for flammable refrigerants it is important that best practice be followed, since flammability is a consideration. The following procedure shall be adhered to:

- safely remove refrigerant following local and national regulations;
- evacuate;
- purge the circuit with inert gas ;
- evacuate;
- continuously flush or purge with inert gas when using flame to open circuit; and
- open the circuit.

The refrigerant charge shall be recovered into the correct recovery cylinders if venting is not allowed by local and national codes. For appliances containing flammable refrigerants, the system shall be purged with oxygen-free nitrogen to render the appliance safe for flammable refrigerants. This process might need to be repeated several times. Compressed air or oxygen shall not be used for purging refrigerant systems.

For appliances containing flammable refrigerants, refrigerants purging shall be achieved by breaking the vacuum in the system with oxygen-free nitrogen and continuing to fill until the working pressure is achieved, then venting to atmosphere, and finally pulling

tdown to a vacuum. This process shall be repeated until no refrigerant is within the system. When the final oxygen-free nitrogen charge is used, the system shall be vented down to atmospheric pressure to enable work to take place. The outlet for the vacuum pump shall not be close to any potential ignition sources, and ventilation shall be available.

Charging procedures

In addition to conventional charging procedures, the following requirements shall be followed.

- Ensure that contamination of different refrigerants does not occur when using charging equipment. Hoses or lines shall be as short as possible to minimise the amount of refrigerant contained in them.
- Cylinders shall be kept in an appropriate position according to the instructions.
- Ensure that the REFRIGERATING SYSTEM is earthed prior to charging the system with refrigerant.
- Label the system when charging is complete (if not already).
- Extreme care shall be taken not to overfill the REFRIGERATING SYSTEM.

Prior to recharging the system, it shall be pressure-tested with the appropriate purging gas. The system shall be leak-tested on completion of charging but prior to commissioning. A follow up leak test shall be carried out prior to leaving the site.

Decommissioning

Before carrying out this procedure, it is essential that the technician is completely familiar with the equipment and all its detail. It is recommended good practice that all refrigerants are recovered safely. Prior to the task being carried out, an oil and refrigerant sample shall be taken in case analysis is required prior to re-use of recovered refrigerant. It is essential that electrical power is available before the task is commenced.

- a) Become familiar with the equipment and its operation.
- b) Isolate system electrically.
- c) Before attempting the procedure, ensure that:
 - mechanical handling equipment is available, if required, for handling refrigerant cylinders;
 - all personal protective equipment is available and being used correctly;
 - the recovery process is supervised at all times by a competent person;
 - recovery equipment and cylinders conform to the appropriate standards.
- d) Pump down refrigerant system, if possible.
- e) If a vacuum is not possible, make a manifold so that refrigerant can be removed from various parts of the system.
- f) Make sure that cylinder is situated on the scales before recovery takes place.
- g) Start the recovery machine and operate in accordance with instructions.
- h) Do not overfill cylinders (no more than 80 % volume liquid charge).
- i) Do not exceed the maximum working pressure of the cylinder, even temporarily.
- j) When the cylinders have been filled correctly and the process completed, make sure that the cylinders and the equipment are removed from site promptly and all isolation valves on the equipment are closed off.
- k) Recovered refrigerant shall not be charged into another REFRIGERATING SYSTEM unless it has been cleaned and checked.

Labelling

Equipment shall be labelled stating that it has been de-commissioned and

emptied of refrigerant. The label shall be dated and signed. For appliances containing FLAMMABLE REFRIGERANTS, ensure that there are labels on the equipment stating the equipment contains FLAMMABLE REFRIGERANT.

Recovery

When removing refrigerant from a system, either for servicing or decommissioning, it is recommended good practice that all refrigerants are removed safely. When transferring refrigerant into cylinders, ensure that only appropriate refrigerant recovery cylinders are employed. Ensure that the correct number of cylinders for holding the total system charge is available. All cylinders to be used are designated for the recovered refrigerant and labelled for that refrigerant (i.e. special cylinders for the recovery of refrigerant). Cylinders shall be complete with pressure-relief valve and associated shut-off valves in good working order. Empty recovery cylinders are evacuated and, if possible, cooled before recovery occurs. The recovery equipment shall be in good working order with a set of instructions concerning the equipment that is at hand and shall be suitable for the recovery of the

flammable refrigerant. If in doubt, the manufacturer should be consulted. In addition, a set of calibrated weighing scales shall be available and in good working order. Hoses shall be complete with leak-free disconnect couplings and in good condition.

The recovered refrigerant shall be processed according to local legislation in the correct recovery cylinder, and the relevant waste transfer note arranged. Do not mix refrigerants in recovery units and especially not in cylinders.

If compressors or compressor oils are to be removed, ensure that they have been evacuated to an acceptable level to make certain that flammable refrigerant does not remain within the lubricant. The compressor body shall not be heated by an open flame or other ignition sources to accelerate this process. When oil is drained from a system, it shall be carried out safely.

PRODUCT SPECIFICATIONS

Model No.	KY-17D1
Rated Power	115V~/60Hz
Cooling Capacity(ASHARE)*	7500BTU/h
Cooling Capacity(SACC)*	4560BTU/h
Refrigeration Input Power/Current*	820w/7.5A
Refrigerant Charge*	R32/0.195kg (6.882OZ)
Waterproof Level	IPX1
Machine size(WxDxH)	313x365x985mm
Net Weight	22.8kgs

※ Due to technical and voltage fluctuations and other precision reasons, the data marked with * in the table may change. Please refer to the nameplate label attached to the product.

NAME OF EACH PART

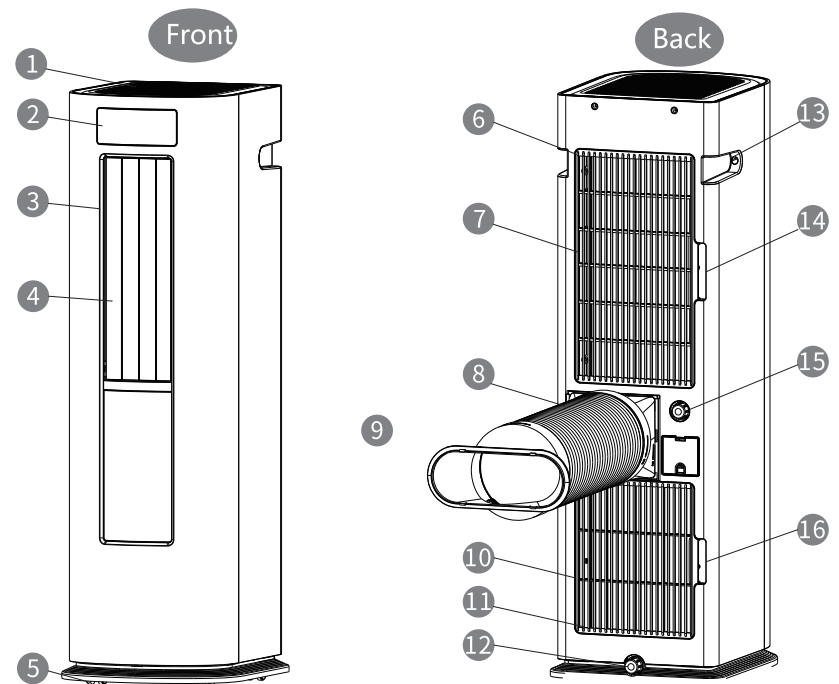

- 1 Top panel
- 2 Front panel
- 3 Air outlet
- 4 Outward swing leaf
- 5 Casters
- 6 Upper air inlet
- 7 Upper filter frame
- 8 Pipe for hot air
- 9 Duckbill joint

- 10 Lower air inlet
- 11 Lower filter frame
- 12 Lower water outlet
- 13 Handle
- 14 Handle for upper filter
- 15 Upper water outlet
- 16 Handle for lower filter

The appearance diagram is just one kind of model, and we company reserves the right to change the design of the product. The product you purchased may have been improved and may not be completely consistent with the intention indicated in the manual, but it will not change the performance or usage method. Please rest assured to use it

CONTROL PANEL

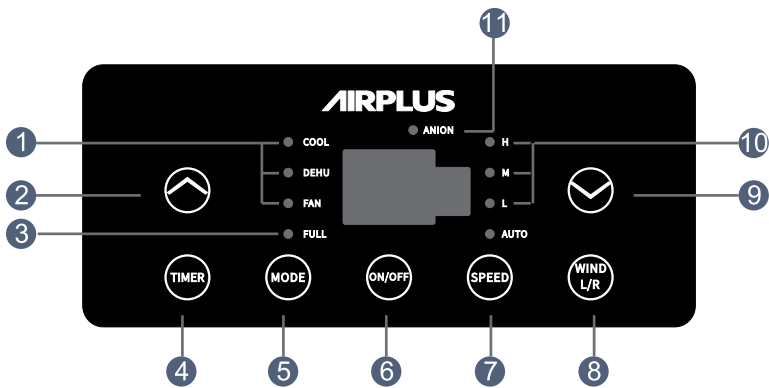

- | | |
|------------------------|---------------------------|
| 1 Mode indicator | 7 Wind speed button |
| 2 Water full indicator | 8 Left and right sweep |
| 3 UP button | 9 DOWN button |
| 4 Timer button | 10 Wind speed indicator |
| 5 Mode key | 11 Negative ion indicator |
| 6 Standby button | |



REMOTE CONTROL



- | | |
|---------------|-----------------------|
| On/Off button | Timer button |
| Speed button | Mode button |
| UP button | DOWN button |
| Anion button | Left and right button |

OPERATION

ON/OFF

- ◆ When the power is turned on, the machine emits a beep sound (refer to the power parameters on the nameplate to connect to the power), and the machine enters standby mode. At this time, the machine can be controlled using the control panel or remote control.
- ◆ Press the standby button , the machine will start up, enter default mode, and the corresponding indicator light will light up; Press the standby button  again, the machine stops working, enters the shutdown state, and all indicator lights turn off. If the machine is not used for a long time, it is recommended to unplug the power cord from the socket.

MODE

- ◆ Select mode: Press  to cycle between cool, dehumidification, air supply, and sleep.
- ◆ Cool mode: The cool indicator light and icon light up, the air conditioner operates according to the set parameters, the target temperature is set by pressing the "∧" or "∨" key, and the speed is adjusted by pressing the "wind speed" key; When the indoor temperature is higher than the set temperature, the compressor starts. When the indoor temperature is lower than the set temperature, the compressor stops working.
- ◆ Dehumidification mode: The dehumidification indicator light and dehumidification icon light up, the air conditioner runs according to the machine's internal program, and the machine defaults to low wind speed operation.
- ◆ Air supply mode: The air supply indicator light and icon light up, and the fan runs at the set wind speed. Press the "wind speed" button to adjust the wind speed. When the air conditioner is in this mode, the compressor does not work.
- ◆ Sleep mode: When the sleep function is on, all except the sleep indicator (30% of normal brightness), The indicator light is out, the wind speed automatically enters the low gear run, pressing the wind speed key is invalid.

TIMER

- ◆ Timed OFF: When turned on, press the button  to activate the timer setting, and the timer indicator light will flash, The display screen displays the set time. Press the "+" and "-" keys to set the target time. Each time the "∧" or "∨" keys are pressed, the time increases or decreases by 1 hour. After stopping the operation for 5 seconds, the timer indicator light will remain on, the timer function will start, and the top panel will restore the set target

temperature (the set temperature during cooling will also be displayed in air supply and dehumidification mode). The front display screen will restore the ambient temperature, and the machine will automatically shut down once the timer duration is reached, The timing range is 0-24 hours (note: the timer function is cancelled when set to 0 hours).



- ◆ Timed ON: In the shutdown state, press the button  once to activate the timer setting. The timer indicator light will flash and the display screen will display the set time. Press the "^" and "v" buttons to set the target time. Press the "+" or "-" button every time, the time will increase or decrease by 1 hour. After stopping the operation for 5 seconds, the timer indicator light will remain on, and the timer function will start. The timer time will last until the machine starts automatically, with a timer range of 0-24 hours. (Note: When setting 0, the timer function is cancelled); When the machine is turned on at a scheduled time, its functions can be preset.

WIND SPEED

- ◆ Wind speed setting: Press  to select "high" → "mid" → "low" → "auto" wind speed, and select in a closed loop; In auto mode, the machine automatically adjusts the wind speed based on the ambient temperature.

- ◆ Note: In dehumidification mode, this button is invalid.

UP & DOWN

- ◆ In cool mode, press "^" and "v" to raise and lower the temperature, temperature setting is 61°F~86°F. In timer mode, press  and  to increase and decrease time.

- ◆ Note: In dehumidification and air supply mode, this button is invalid.

ANION

- ◆ Long press the mode key  to turn on or off the anion function. After turning on, the anion indicator and the icon will light up, and vice versa, it will be turned off.

WIND LEFT/RIGHT

- ◆ Press  to turn on or off the automatic wind left/right function. After turning it on, the wind left/right indicator and the icon will light up, and vice versa, it will be turned off.

Kind reminder

- ◆ When the air conditioner is cooling, in order to reach better cooling effect, it is necessary to install heat pipe on the machine to guide the hot air to the outside (the installation method of heat pipes is described later).

- ◆ In cool mode, the machine will stop working when temperature is high than 109.4°F or lower than 59°F.

OTHER FUNCTIONS

Defrost

- ◆ The machine has an automatic defrosting function, which automatically detects the temperature and determines whether defrosting is needed during operation, ensuring that the machine still has good heating performance even in low ambient temperatures.
- ◆ Note: This key is invalid in air supply and dehumidification mode

Anti freezing protection

- ◆ This machine has anti freezing protection function. When the machine is working, it will automatically detect the temperature and determine whether the anti freezing function needs to be activated. This ensures that the machine still has good refrigeration performance when the ambient temperature is low.

Auto water full protection

- ◆ When the machine detects that the water level in the water tray has reached the preset height, the compressor, motor, and water throwing motor stop working. The machine emits 10 alarm sounds, and the screen shows "FU", and the machine stops working.
- ◆ After drainage, the machine returns to the state before it is full of water.

Compressor shutdown/start protection

- ◆ During the operation of the machine, if any operation causes the compressor to stop working. At this time, the machine automatically switches to the protection function of stopping the compressor for 3 minutes before restarting, which means the compressor will not start again within 3 minutes, and other functions have outputs.
- ◆ The compressor will run for at least 3 minutes after each start before stopping operation (except for shutdown).

PREPARATION FOR USING THE REMOTE CONTROL

- ◆ Before using the remote control, please correctly install two AAA-sized dry batteries into the battery compartment of the remote control.



PRECAUTIONS FOR USING REMOTE CONTROL

- ◆ 1. Align the signal transmitter with the signal receiving window on the air conditioner during use.
- ◆ 2. The distance between the signal transmitter and receiver window should generally be within 6 meters, and there should be no obstacles.
- ◆ 3. In rooms equipped with electronic start type fluorescent lamps, conversion type fluorescent lamps, or wireless telephones, the signal is easily disturbed. The remote control should be as close to the air conditioner as possible.
- ◆ 4. When not using the remote control for a long time, it is recommended to remove the battery from the remote control.

CLEANING AND MAINTENANCE

Warning

- ◆ Before cleaning the air conditioner, it must be turned off and the power must be cut off, otherwise there is a risk of electric shock.
- ◆ Do not rinse the air conditioner with water, or there will be a risk of electric shock.
- ◆ Do not use volatile liquids (such as diluents or gasoline) to clean the machine, otherwise it will damage the appearance of the machine.

Clean the shell and grille

1. Remove the filter frame
Buckle out the rear filter frame to the side as shown in the picture; Then remove the side filter frame from the other side.

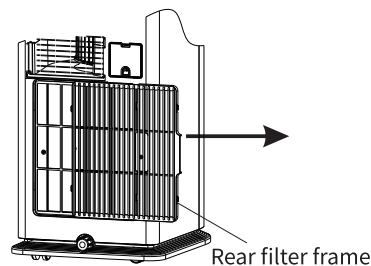

2. Clean the filter frame
Use a vacuum cleaner or clean the filter frame with clean water. When the filter frame is dirty (such as oil), it can be cleaned with warm water dissolved in neutral detergent, and then dried in a cool place

3. Install the filter frame
After cleaning and drying the filter, reinstall it into the machine.

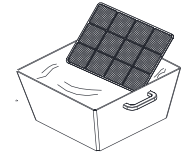

Attention:

- ◆ It is recommended to clean the filter frame every 20 days of use. If used in a dusty environment, the cleaning frequency of the filter frame should be increased.
- ◆ Do not dry the filter frame with fire or a hair dryer, as it may deform or catch fire.

Clean the heat discharge pipe

- ◆ Remove the pipe from the air conditioner and then clean it (using the same cleaning method as the filter frame), air dry and then reinstall it.

Inspection before the usage season

1. Check if the air inlet and outlet are blocked.
2. Check if the plug and socket are in good condition.
3. Check if the filter is clean.
4. Check if the remote control is equipped with a battery.
5. Check if the heat pipe is damaged and if it is securely installed.

Inspection after the usage season

1. Cut off the power supply of the air conditioner.
2. Clean the filter frame and shell.
3. Remove accumulated water from the built-in drain tray (please refer to the "Drainage Method" section for details).

Long term storage

- ◆ If you do not use the air conditioner for a long time, it is recommended that you follow the following steps to maintain the good performance of the air conditioner:
 1. Ensure that there is no accumulated water in the drain tray and remove the heat pipe.
 2. Remove the plug and pack the power cord properly.
 3. Clean the air conditioner and package it to prevent dust accumulation.

Recycling precautions



Please do not dispose of electrical appliances as unclassified urban waste and collect them separately. Facilities, if electrical appliances are disposed of at will in landfills or storage areas, harmful substances, It can seep into groundwater and enter the food chain, damaging your health and well-being.

Restore factory settings

- ◆ Simultaneously press and hold the "+" and "-" keys to restore the device to its factory settings, clear memory data such as temperature and wind speed, and restore initial data

INSTALLATION PRECAUTIONS

Attention:

1. Please comply with all local laws and regulations during installation.
2. Do not use damaged or non-standard power cords.
3. Pay attention to safety during installation and maintenance, prohibit illegal operations, and avoid accidents such as electric shock, high-altitude falling injury, and even death.

Location selection

◆ Basic requirements:

Installing in the following areas may cause air conditioner malfunctions. If unavoidable, please consult your local dealer

1. Areas with strong heat source vapors, flammable and explosive gases, or volatile substances dispersed in the air.
2. Areas with high-frequency facilities (such as welding machines, medical equipment).
3. Seaside salt area.
4. Areas with oil content in the air.
5. Areas containing sulfur gas.
6. Other special environmental areas.
7. Unstable or moving foundations (such as trucks) or in corrosive environments (such as chemical plants).

◆ Peripheral environment requirements:

1. Keep the air inlet away from obstacles, and do not place any objects near the air outlet, otherwise it will affect the heat dissipation of the pipe.
2. Noise and airflow will not affect neighboring areas.
3. Please try to stay away from fluorescent lamps as much as possible. Injury, and even death.

Electrical connection requirements

◆ Safety precautions:



1. Please make sure to follow the electrical safety regulations and install the air conditioner.
2. According to local electrical safety regulations, a dedicated power supply line should be configured when using this product.
3. Please ensure that the power supply meets the requirements of the air conditioner. Unstable power supply or incorrect wiring may cause electric shock, fire, or electrical component failure. Please contact the power personnel to resolve the issue before using the machine.
4. Please make sure to correctly connect the live wire, neutral wire, and ground wire of the power socket.
5. Before carrying out any electrical safety work, please make sure to cut off the power supply of the air conditioner.

6. Do not turn on the power until all installations are completed.
7. This electrical appliance belongs to Class I appliances and must be properly grounded. Connect the ground wire to a dedicated grounding device to ensure effective grounding at all times. Improper grounding may cause electric shock.
8. The grounding resistance should comply with the electrical safety regulations of the local country.

PREPARATION BEFORE INSTALLATION

Tip: Please check if the accessories are complete before installation.

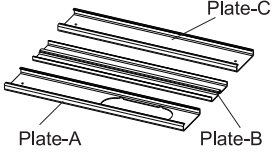
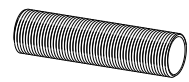
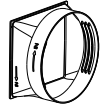
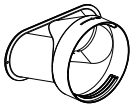
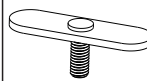
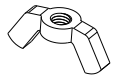
Accessories List

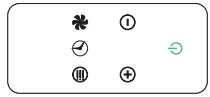
 <p>Plate-C Plate-A Plate-B Window isolation pane</p>	 <p>Heat discharge pipe</p>	 <p>Pipe joint</p>
 <p>Duck billed adapte</p>	<p>Screw*2</p>  <p>Screw arbor*2</p>	 <p>Butterfly nut*2</p>
 <p>Flat washer*2</p>	<p>Sponge*2</p>  <p>Drainage pipe</p>	 <p>Remote control</p>

Usage suggestions:

- ◆ There is a compressor inside the machine. If there is dumping or long-distance transportation, please stand the machine upright for more than 4 hours to allow the condensate to fully reflux, and then turn on the machine. When the temperature exceeds 109.4 °F or falls below 59°F, the refrigeration function will automatically protect the machine from running.
 1. In the power on state, when the timer is not turned on, the machine will automatically start up after powering off and then on, without pressing the standby button.
 2. After normal shutdown, if there is a power outage or continuous power outage, the last working mode will be remembered.

DRAINAGE METHOD

- ◆ When operating in cool mode, manual drainage is generally not required, but when operating in high temperature and high humidity environments, there may be a situation of water full, which requires manual or continuous drainage.
- ◆ When operating for a long time in dehumidify mode, it is necessary to connect a drainage pipe for drainage. The drainage pipe can be connected to the middle or lower drainage outlet. It is recommended to connect to the middle drainage outlet.
- ◆ When operating for a long time in heating mode, it is necessary to connect a drainage pipe for drainage, and connect the drainage pipe to the drainage outlet.
- ◆ Regardless of the mode in which the machine operates, when the water tray is detected to be full, the buzzer will sound and the screen will display "FU" to remind you to drain. At this time, it is necessary to open the lower drain outlet for drainage.
- ◆ After the water is completely removed and the compressor stops running for 3 minutes, the air conditioner will resume operation.

Drainage steps:

1. Cut off the power and move the machine to the appropriate position.
2. Prepare a slightly shallow plate and place it near the lower drain or move the machine to the floor drain.
3. Rotate counterclockwise to remove the water stop button on the lower drainage outlet, pull out the rubber plug, and water will automatically flow out of the drainage hole. In order to drain the water more thoroughly, the machine can be slightly tilted back (see Figure FIG1).
4. After draining the water, reverse the process and install the rubber plug and water stop knob. Attention: When cooling at high temperatures and high humidity, if you want to avoid shutting down when water is full, you can connect the drainage pipe to the drainage outlet (it is recommended to lower the drainage outlet) for continuous drainage to ensure that the drainage pipe runs smoothly straight down. (See Figure FIG2).

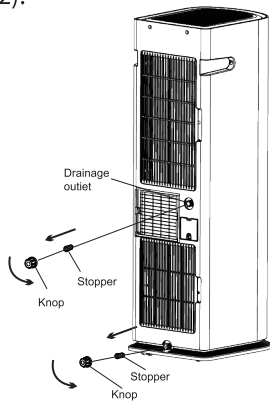

FIG1

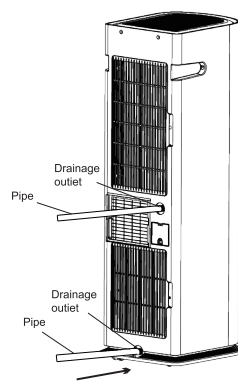
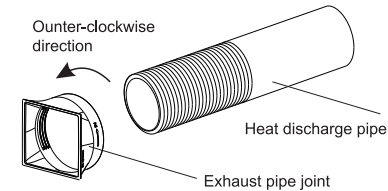

FIG2

INSTALLATION AND REMOVAL OF HEAT DISCHARGE PIPE

Installation

1. Tighten the heat discharge pipe joint counterclockwise to either end of the heat discharge pipe.



2. Tighten the duckbill shaped adapter counterclockwise to the other end of the heat discharge pipe.

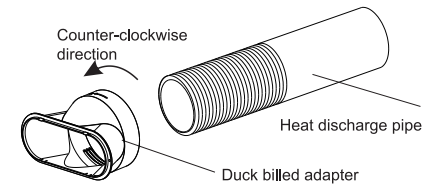

3. Insert the heat discharge pipe joint from top to bottom into the rear shell slot. If you hear a "click" sound, it indicates that the card slot has tightened the joint.

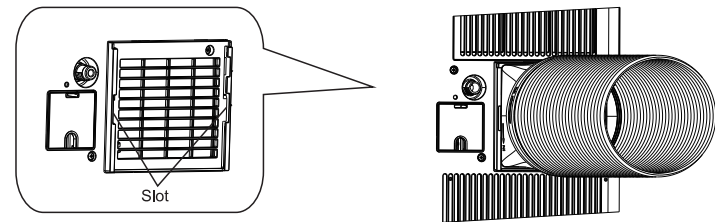

4. Guide the outlet of the heat pipe to the outside.

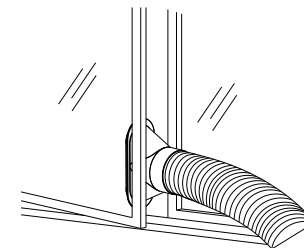

PRECAUTIONS FOR INSTALLING HEAT DISCHARGE PIPE

In order to improve refrigeration efficiency, the installation of heat pipes should be as short and flat as possible, without distortion, and to maintain the smoothness of the heat discharge pipe

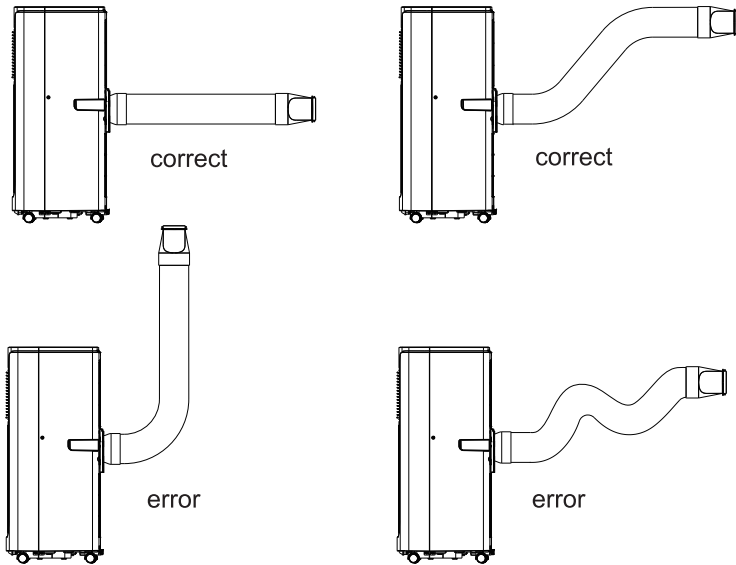

Disassemble

Remove the heat discharge pipe joint: Gently tap the heat discharge pipe joint upwards with your hand to remove the limit point of the heat pipe joint from the slot.

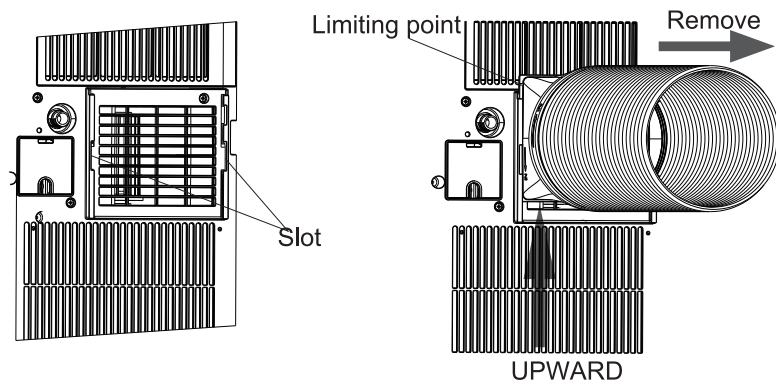

INSTALL WINDOW ISOLATION PANELS

1. After threading the screw through the hole on the isolation plate A, place a flat gasket on the screw and tighten the nut. Be careful not to hold the nut to the bottom, leaving a 2-3mm gap.

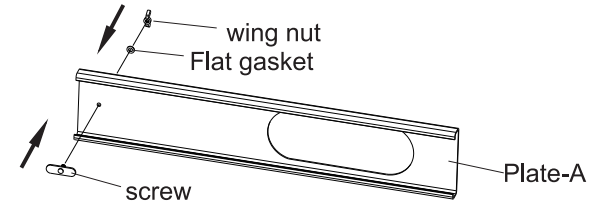

2. After threading the screw through the hole on the isolation plate C, place a flat gasket on the screw and tighten the nut. Be careful not to tighten the nut to the bottom, leaving a 2-3mm gap.

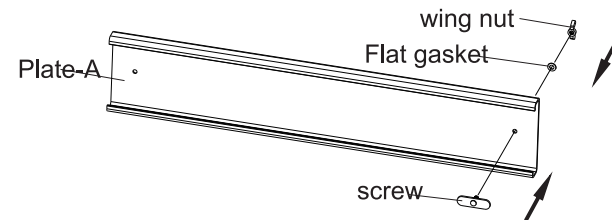

3. Install the window isolation plates A and C, which were installed in steps 1 and 2, from both ends of the window isolation plate B. When installing, be sure to align the fixing plates on the screws with the sliding grooves of the B plate and insert them.

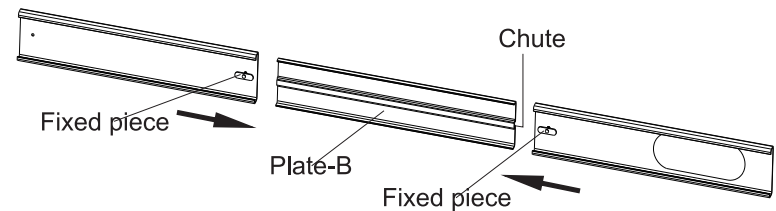

4. Adjust the position of plates A and C on board B through the sliding groove on board B to reach the required length. Then, tighten the butterfly nut clockwise to the end to firmly fix the relative positions of plates A, B, and C.

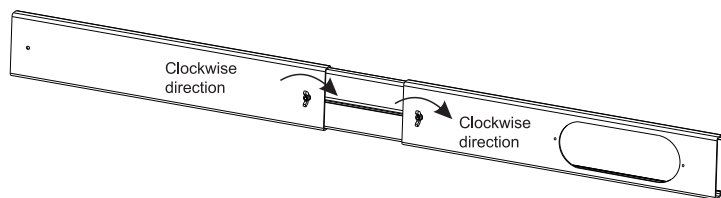

5. Install the duckbill shaped adapter with the installed heat pipe onto the window isolation plate A, installation steps
 (1) Insert the duckbill shaped adapter into the runway shaped hole on board A
 (2) Tighten the duckbill adapter to the window isolation plate A with screws

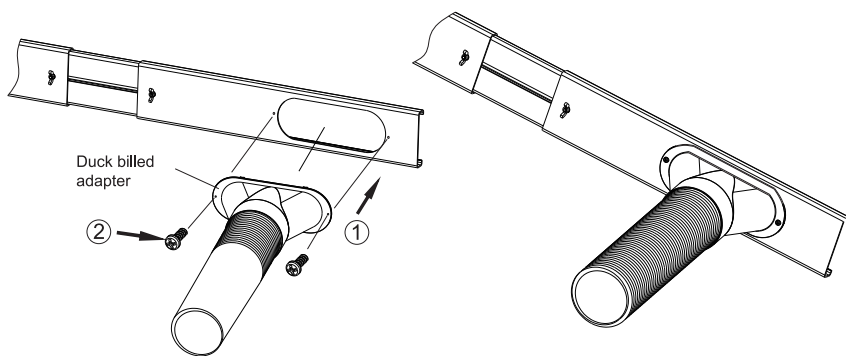

(Installation process diagram)

(Schematic diagram after installation is completed)

6. Install the matched window isolation panel on the window frame, which can be installed horizontally or vertically

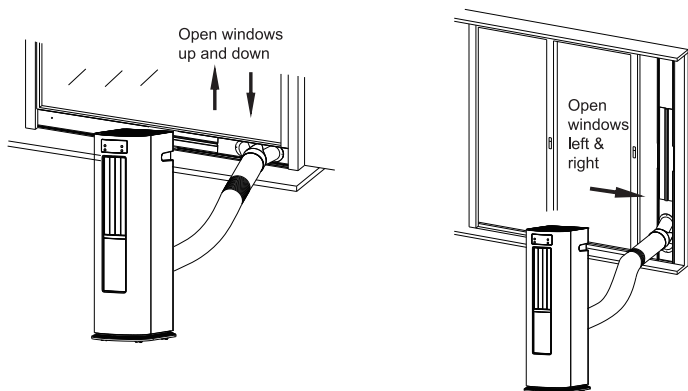

TROUBLESHOOTING

General analysis

Please press the following table for troubleshooting before contacting the maintenance. If the problem still cannot be solved, please contact the dealer or professional in time.

Clockwise

Problem	Possible cause	Solution
Not working	Power off?	Wait for power
	Plug loose?	Plug it back in.
	Power switch trip or blow a fuse?	Ask a professional to replace the power switch or fuse.
	Line faulty?	Ask a professional to replace the line.
	Stop running and start up again immediately?	Please wait 3 minutes and then restart
Smelly	any odors in the room such as furniture, cigarettes, etc.?	Remove odor sources. Clean the filter.
	Low voltage?	Wait for the voltage to return to normal.
Cooling (heating) is not good	Dirty filter?	Clean the filter
	Proper temperature?	Adjust to the proper temperature.
	Doors and windows are closed?	Close the doors and windows.
	Pipe is outside?	Let the pipe outside.
	Strong interference (such as static electricity, abnormal supply voltage)?	Please unplug it. After about 3 minutes, plug it back in and turn it on again
Can not receive the remote control signal or the remote control operation is not sensitive, no response	Remote control in range?	Remote control receiving range within 6 meters, do not exceed this range
	Proper temperature?	Remove obstacles.
	Low sensitivity of remote control	Check the battery of the remote control. If the battery is too low, replace the battery.
	Whether the room has fluorescent lights	Let the remote control is near the machine. Turn off the lights and try again.
	No wind blows out of the machine	The inlet or outlet of the machine blocked?
Room temperature reached the set temperature ?		The machine will stop blowing air when the set temperature is reached.
No cooling	The ambient temperature below the set temperature?	This is a normal phenomenon, if you need to cool please lower the set temperature
	Blow mode?	Change to cooling mode

Problem	Possible cause	Solution
set temperature cannot be adjusted	Operate in air supply or dehumidification mode?	This is a normal phenomenon, the air supply/dehumidification mode temperature is not adjustable
	Required temperature within the set temperature range of the air conditioner?	Et temperature range: 61°F~86°F, beyond the range of the temperature cannot be adjusted.
Sudden abnormal operation during operation	Lightning, radio and other interference?	Turn off the power, turn it on, and turn it back on
Hear the sound of water	Just turn the machine on or off?	The sound caused by refrigerant flow in the air conditioner is a normal phenomenon.
Hear a crack	Just turn the machine on or off?	The temperature change causes the panel and other parts to expand and shrink, causing the sound of friction.

Fault code

Problem	Cause	Solution
E1	Jevaporator temperature sensor is faulty	Contact a professional
E2	Condenser temperature sensor is faulty	Contact a professional
FU	Water tank is full	1. Drain the water from the water tank. 2. If FU is still displayed after the water tank is emptied, notify maintenance personnel

 us.airplus@gmail.com
s.frankie@aoutkehome.com

订单号	BC0250306003
文件名称	美国17D1说明书
更新时间	20250703
版本号	E-0.0.0
尺寸规格	138×210mm
材质	128g铜版纸
印刷要求	彩印