

**IMPORTANT:** Read the instructions carefully before operating the appliance and keep them for future reference.



GEEK TECHNOLOGY CO., LTD  
120 Route 46 West,  
Parsippany, NJ 07054,  
Toll Free  
1-844-801-8880

WELCOME

GeekTale bids you welcome to a world of smart home devices, smart locks, and smart surveillance. We at GeekTale strive to explore and develop the smart home industry for the good of all. We use cutting-edge technologies to develop products fit and ready for the market.

Please visit our website [www.geektechnology.com](http://www.geektechnology.com). Before installing, please scan the QR codes to watch our easy step-by-step installation video. If you have questions regarding the installation process, please contact us by mail [service\\_lock@geektechnology.com](mailto:service_lock@geektechnology.com) or by phone 1-844-801-8880.



Scan the QR code for more Geek Tale Products

PRODUCT DESCRIPTION

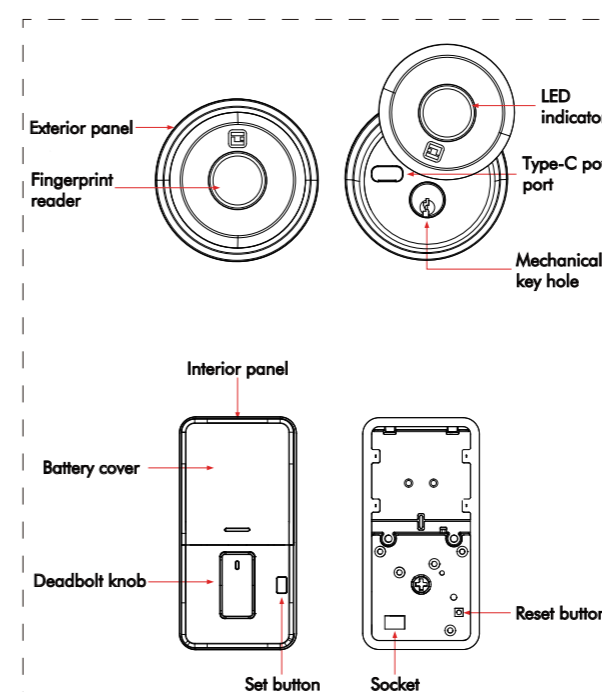

2

INCLUDED IN THE BOX

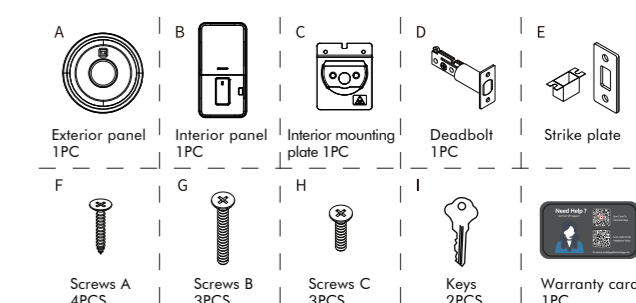

ASSEMBLY DIAGRAM

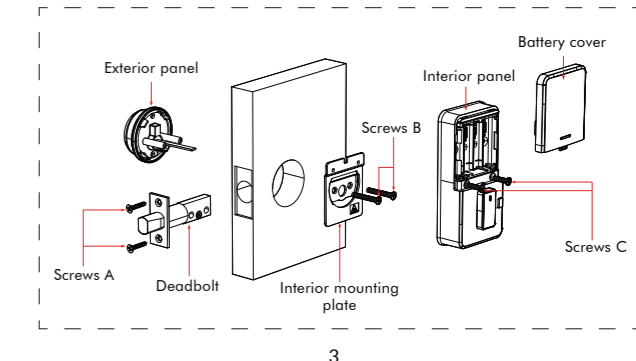

3

CHECK THE DOOR'S DIMENSIONS

- Step 1: Measure to confirm that the door is between 1 3/8"-2 1/8" (35mm-54mm) thick.
- Step 2: Measure to confirm that the hole in the door is 2 1/8" (54mm).
- Step 3: Measure to confirm that the backset is either 2 3/8" - 2 3/4" (60-70mm).
- Step 4: Measure to confirm that the hole in the door edge is 1" (25 mm).

**Note:** If you have a new door, please drill the holes according to Drill Template.

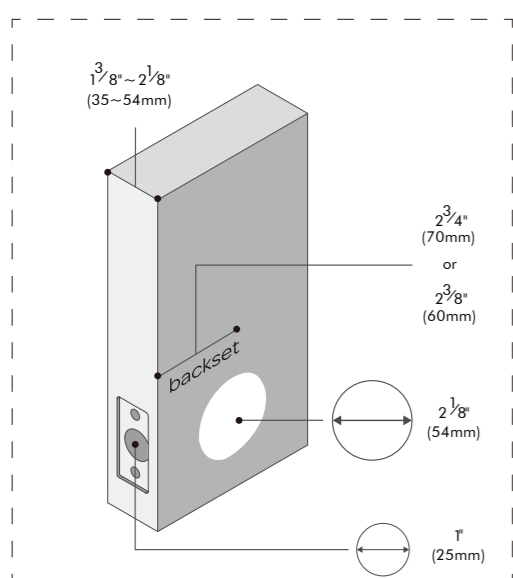

4

INSTALL LATCH AND STRIKE PLATE

1. Install latch into the door, make sure latch fits inside the door opening.
2. Install the strike into the door frame, make sure the latch can go into the strike smoothly.

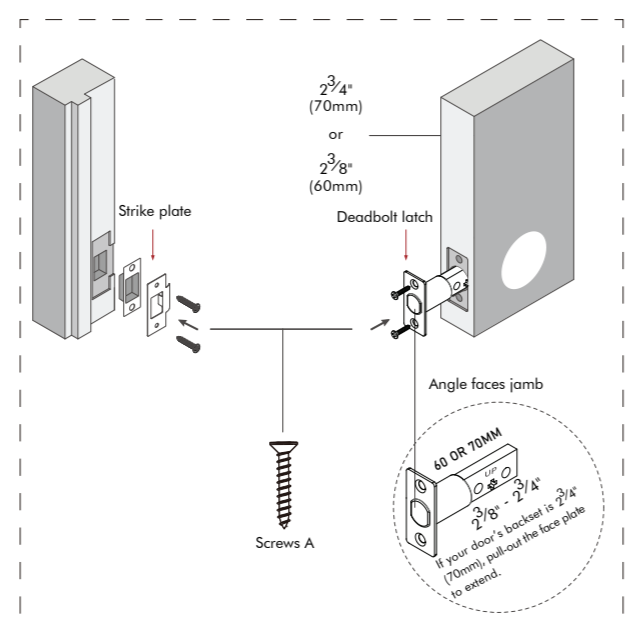

5

CHECK BEFORE INSTALLATION

RIGHT OR LEFT OPEN FOR YOUR DOOR.

RIGHT HINGE DOOR

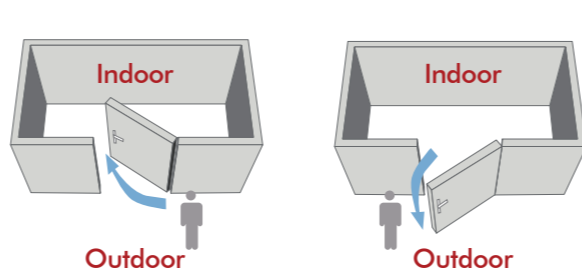

LEFT HINGE DOOR

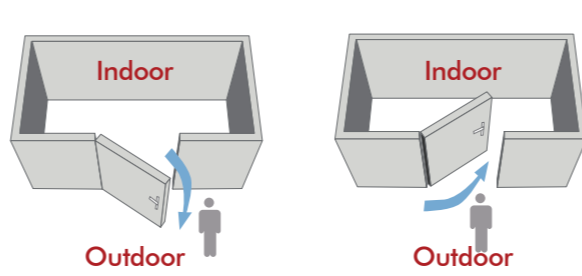

6

INSTALL EXTERIOR PANEL

DO NOT CLOSE THE DOOR UNTIL THE DOOR LOCK IS FULLY INSTALLED AND THE BATTERIES ARE INSTALLED.

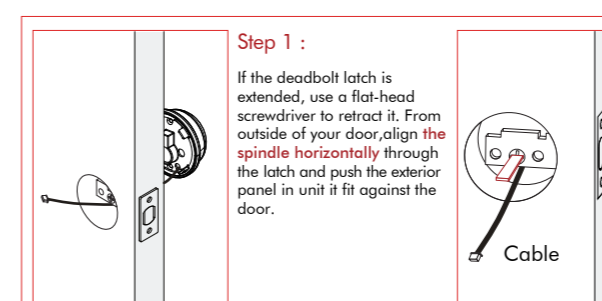

Step 2:

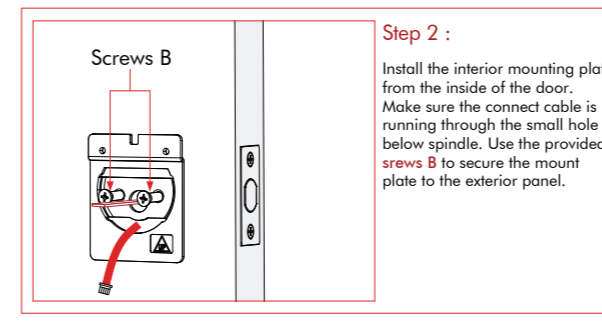

7

INSTALL INTERIOR PANEL FOR RIGHT HINGE

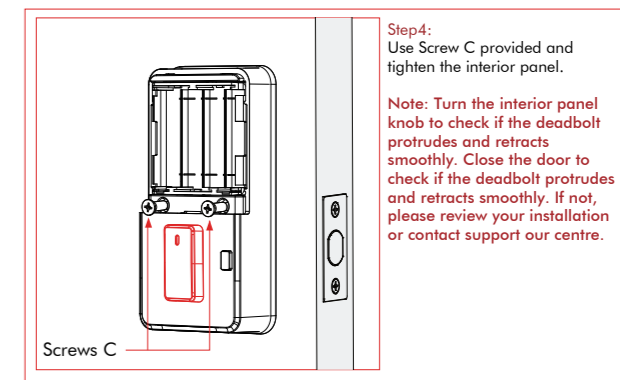
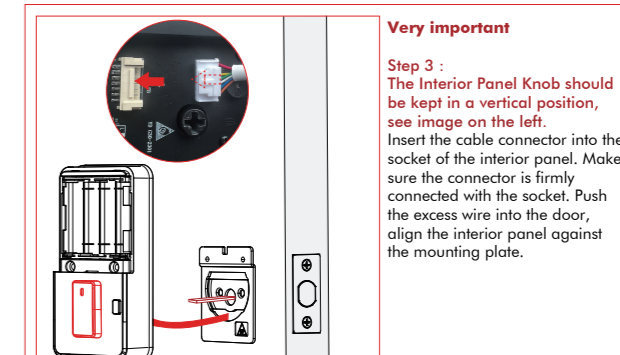

8

INSTALL INTERIOR PANEL FOR LEFT HINGE DOOR

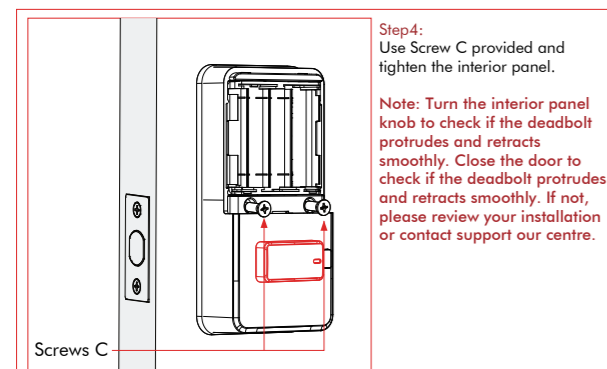
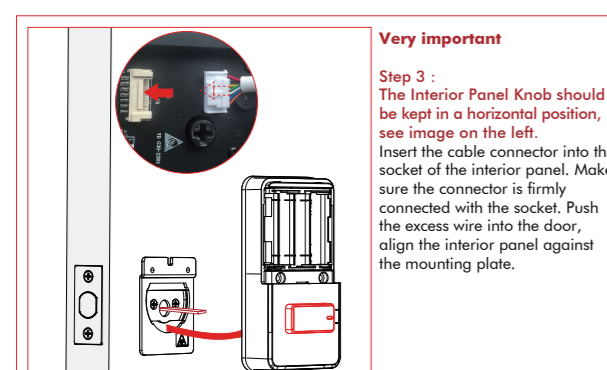

9

INSTALLING BATTERIES

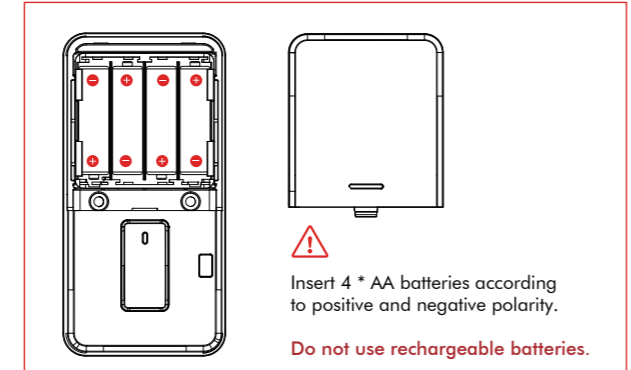

DOWNLOAD THE GEEKSMART APP

1. App Download Instructions
  - A: Scan the QR code on the right if you can use Android and iOS to download the APP.
  - B: Android version software can be downloaded in the Google Play store. Search "GeekSmart".
  - C: iOS version of the software can be downloaded in the iPhone App Store. Search "GeekSmart".
2. Register and log in with your E-mail address.



10

ADDING DEVICE

1. Adding new door lock by app  
(Note: Keep your phone close by the door during this process).

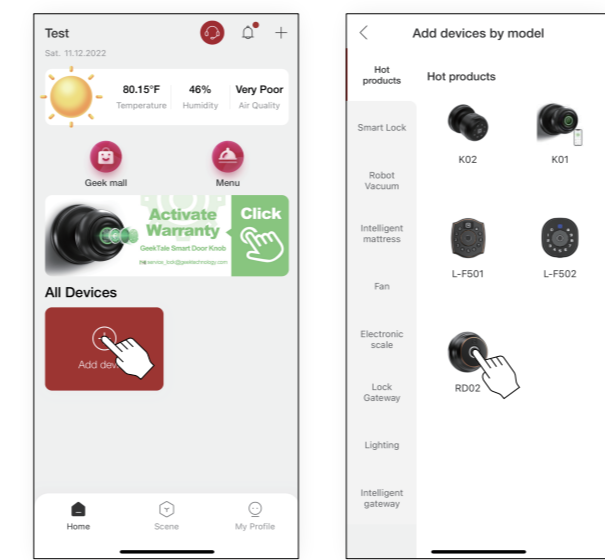

- 1 Tap the add button "+".
- 2 Select the smart lock.

11

After adding the device(s) (3), you will see the RD02 main page (as (4)). Select Right Hinge or Left Hinge door opening.

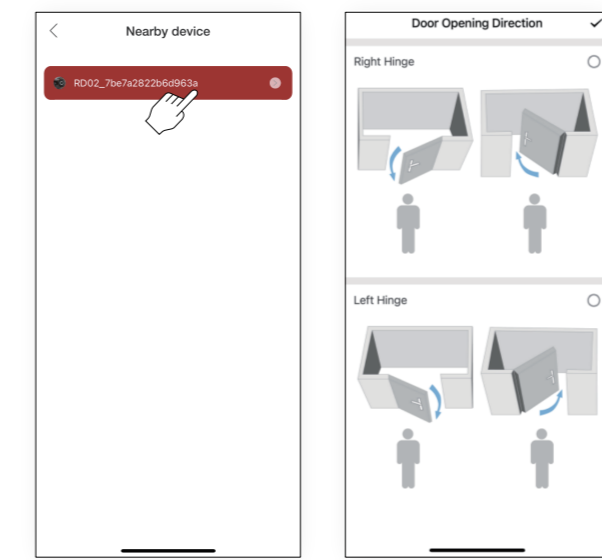

- 3 Select your lock.
- 4 Select right hinge or left hinge door opening.

12

HOW TO ADD FINGERPRINT

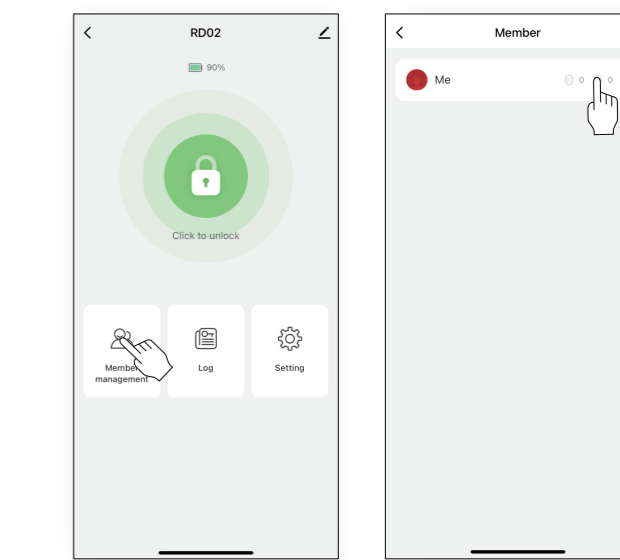

- 1 Click member management.
- 2 Click me.
- 3 Continue to follow the instruction on the App interface.

13

HOW TO DELETE FINGERPRINT

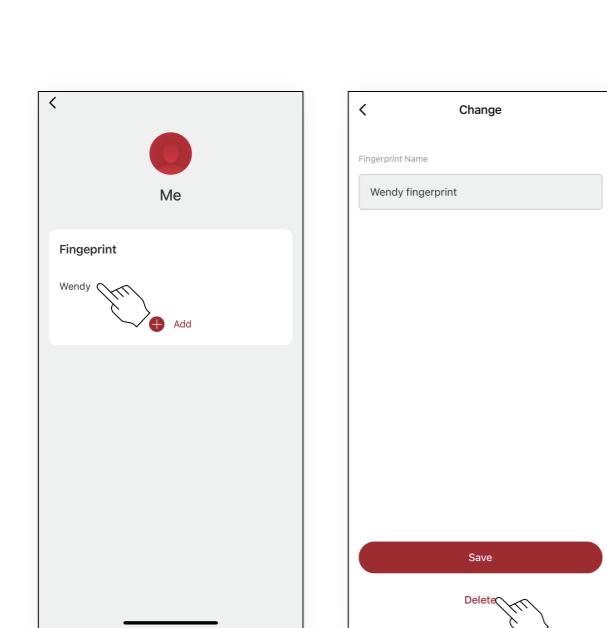

- 1 Tap the fingerprint you want to delete.
- 2 Tap delete.

14

TROUBLESHOOTING

- Q: How to reset the RD02?
- A: Long press the reset button on the interior panel until you hear the buzzer.
- A: Please select "restore factory setting" or "Delete device" by GeekSmart APP.
- A: Remove then reinstall the batteries, press and hold the "Set Button" until the fingerprint indicator flash red light, then enter fingerprint reader for reset the device.
- Q: Does RD02 work with third-party accessories such as deadbolt latch?
- A: It is recommended to use the original accessories for best performance and stability.
- Q: What notification will I receive when the battery is low?
- A: After the fingerprint or are successfully unlocked (the buzzer beeps once, the fingerprint reader flashes green and then flashes red). When you unlock the device through the mobile App, you will receive a push notification message with low battery warning.
- A: The remaining power can provide about 100 times to unlock. Please replace battery in time.
- Q: How can I unlock RD02 if battery runs out?
- A: On exterior panel, connect a power bank to the deadbolt with type-C cable as to activate for emergency access.
- Q: Why RD02 doesn't lock or unlock?
- A: Check for low batteries.
- A: Try to see if you can manually lock the door. (to see if you install the lock correctly).
- A: Please check whether Bluetooth is enabled on your mobile phone.
- Q: Speaker does not make noise when unlocking and locking although Smart lock has power.
- A1: Please check the GEEK APP in the setting to see if you have set to the mute mode.

15

A2: After A1 check, no setting the problem, it is possible that the speaker is broken. Then you should contact us to replace the lock.

- Q: My smart lock doesn't respond. It is not powering and the front light doesn't flash. In this case, the device can't connect to any smartphone.
- A: The fast solution will be the replacement of the batteries.
- A: Re-connect the cable is also a good way to go.
- Q: My smart lock manually locks but doesn't connect to the phone.
- A: Go to the settings and check the Bluetooth connection. Make sure that the Bluetooth is on and connected to the device. If Bluetooth is on and connected, then there may be an issue with the motherboard.
- Q: The gears are not functioning.
- A1: Unlock with the right fingerprint or password or BLE, pay attention if the lock is in security mode (only the master can unlock.).
- A2: After A1 check, the problem is still here, contact us to replace a lock.
- Q: How to enable or disable the security mode?
- A: Long press the set button for 5 seconds, security mode is enabled. In the security mode, only BLE or "Me" account's fingerprint can unlock the lock, other fingerprint can not unlock.
- A: Once "Me" account's fingerprint unlock, or short press the set button again, security mode will be disabled.

16

FCC WARNING

Any Changes or modifications not expressly approved by the party responsible for compliance could void the user's authority to operate the equipment.

**Note:** This equipment has been tested and found to comply with the limits for a Class B digital device, pursuant to part 15 of the FCC Rules. These limits are designed to provide reasonable protection against harmful interference in a residential installation. This equipment generates uses and can radiate radio frequency energy and, if not installed and used in accordance with the instruction, may cause harmful interference to radio communications. However, there is no guarantee that interference will not occur in a particular installation. If this equipment does cause harmful interference to radio or television reception, which can be determined by turning the equipment off and on, the user is encouraged to try to correct the interference by one or more of the following measures:

- Reorient or relocate the receiving antenna.
- Increase the separation between the equipment and receiver.
- Connect the equipment into an outlet on a circuit different from that to which the receiver is connected.
- Consult the dealer or an experienced radio/TV technician for help.

This device complies with part 15 of the FCC Rules. Operation is subject to the following two conditions: (1) This device may not cause harmful interference, and (2) this device must accept any interference received, including interference that may cause undesired operation.

17

SPECIFICATIONS

Technical Parameters		
No.	Name	Parameter Description
1	USB	Type-C/ 5V2A
2	Fingerprints max	50
3	Low power warning	4.8V±0.2
4	Voltage range	4.5-6.5V
5	Stand-by current	Without connect to APP 60uA Connect to APP 75uA
6	Working current	<250mA
7	Unlock time	=1.5 sec
8	Range of working Temperature	Exterior panel -13°F-158°F Interior panel 14°F-131°F
9	Door thickness	1 3/8"-2 1/8" (35-54mm)
10	Material	Aluminum alloy lock+ plastic cover plate body
11	Power	4*AA alkaline batteries

18