



BEYONDBEAM™

UFO High Bay



SKU #	DLC Model #
157063	BLT-HB26-240WS1B60/80/100A1-BH30/40/50WD

BEYOND LED Technology's BEYONDBEAM LED UFO High Bay Light is a highly versatile and energy-efficient lighting solution designed for a wide range of industrial and commercial applications. Offering adjustable wattages (160W, 200W, 240W) and adjustable CCT options (3000K, 4000K, 5000K), this high bay light allows you to tailor the light output to suit your specific needs. With adjustable beam angles of 60°, 80°, and 100°, the beam angles can be easily customized using the DIP switch, providing convenient and precise control for different lighting requirements. Featuring a Sosen non-isolated driver, the BEYONDBEAM LED UFO High Bay delivers up to 170 lumens per watt, ensuring bright, energy-efficient illumination. The fixture comes with a O-hook mount and sensor base, offering easy installation and optional motion sensing for additional energy savings. With a 120-277V input voltage range and a sleek black finish, it's ideal for a variety of environments, providing both durability and performance.

Product Features

- Up to 170 lm/W
- Adjustable wattage
- Adjustable CCT
- Adj. Beam Angle 60°/80°/100°
- 0-10V Dimmable
- Sosen driver
- O-Hook mount included
- Black Housing
- UL & DLC Listed
- 5-year warranty

BEYONDBEAM™

UFO High Bay



SKU	ADJ. WATT	MAX LUMENS	ADJ. CCT	INPUT VOLTAGE	CRI	LIGHT SPREAD	CONSTRUCTION	DIMMING	IP RATING	CERTIFICATIONS
157063	160W/200W/240W	37800	3000K/4000K/5000K	120-277V	>80	60°/80°/100°	Die-cast Aluminum+PC	0-10V	IP65	UL & DLC

SKU: 157063

Specifications

Parameter	Description	Value
General Performance	Model No.	BLT-HB26-240WS1B60/80/100A1-BH30/40/50WD
	Adjustable Watt	160W / 200W / 240W
	Max Lumens	37800
	Lumen Efficacy	Up to 170LM/W
	Color Temperature	3000K / 4000K / 5000K
	CRI (Ra)	>80
	Light Spread	60° / 80° / 100°
Electrical	Input Voltage	120-277Vac
	Distribution Pattern	PC Lens
	Frequency	50/60Hz
	Dimming	0-10V
	PF (Tolerance: -3%)	≥0.9
	THD (Tolerance : +5%)	≤20%
	Flicker Percent	<5%
Physical	Driver Brand	Lifud Driver
	Driver Model	LF-FHB240YAIV
	Driver Surge Protection	L/N-PE: 6kV, L-N: 6kV
	Operating Temperature	Without Motion Sensor -40°C TO 50°C With Motion Sensor: -30°C TO 50°C
	Storage Temperature	-40°C TO 80°C
	Operating Humidity	20% - 90% RH
	Storage Humidity	10% - 95% RH
Qualification	LED Brand	Lumileds
	LED Type	SMD2835
	LED QTY	250*4PCS
	Construction	Die-cast aluminum
	Housing Color	Black
	IP Rating	IP65
	Warranty	5 Year warranty

UFO HIGH BAY



BEYONDBEAM™

UFO High Bay

Correlated Color Temperature (CCT)

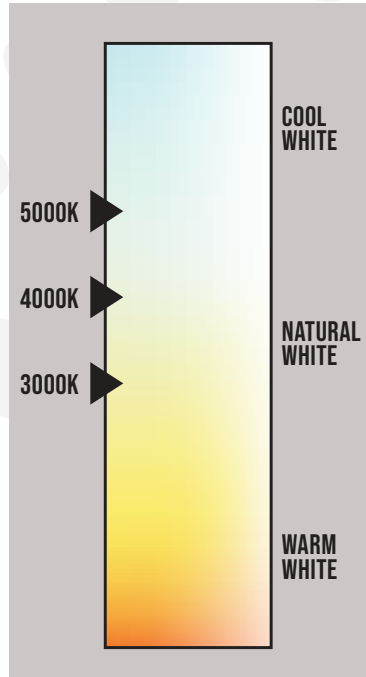

Dimensions

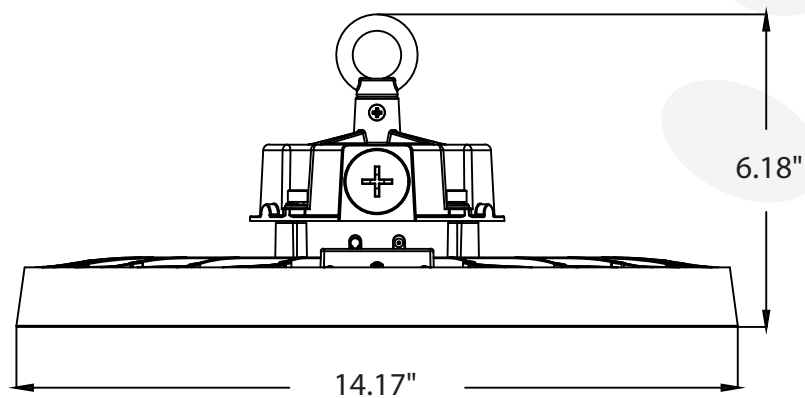

BEYONDBEAM™

UFO High Bay



Photometric Data

Luminaire Property

Luminaire Manufacturer:
 Luminaire Category:
 Lamp Catalog:
 Number of Lamps:
 Luminous Length (mm): -320
 Luminous Height (mm):
 Current: 2.015 A
 Power Factor: 0.998

Luminaire Description:
 Lamp description:
 Lumens Per Lamp:
 Luminous Width: -320
 Voltage: 120.0V
 Power: 241.29 W

Photometric Results

CIE Class: Direct
 Measurement Flux: 32456 lm
 Downward Ratio: 99%
 Horizontal Diffuse Angle(10%,50%): H129.3,H97.2
 Vertical Diffuse Angle(10%,50%): V129.2,V97.7
 Luminaire Efficacy Rating (LER): 134.56
 Max. Intensity: 14264.41 cd
 C/MH(C0/C180): 1.39

Total Rated Lamp Lumens: 32456.0 lm
 Efficiency: 100%
 Upward Ratio: 1%

C0r0 Intensity: 14242.35 cd
 Pos of Max. Intensity: H270 V4
 S/MH(C90/C270): 1.39

Luminous Intensity Distribution Curve

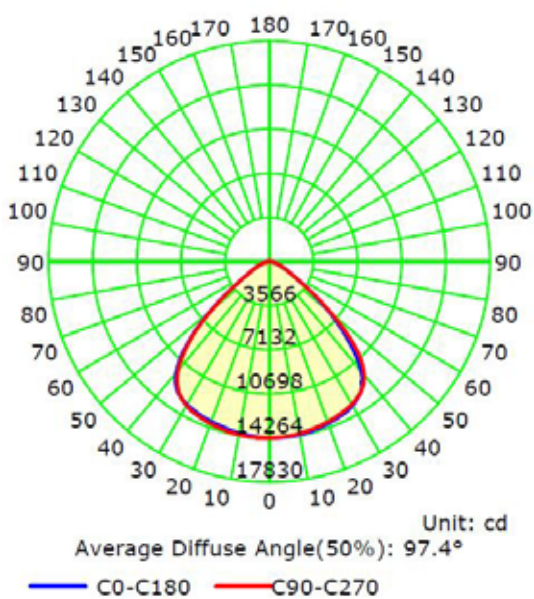

The Average Illuminance Effective Figure

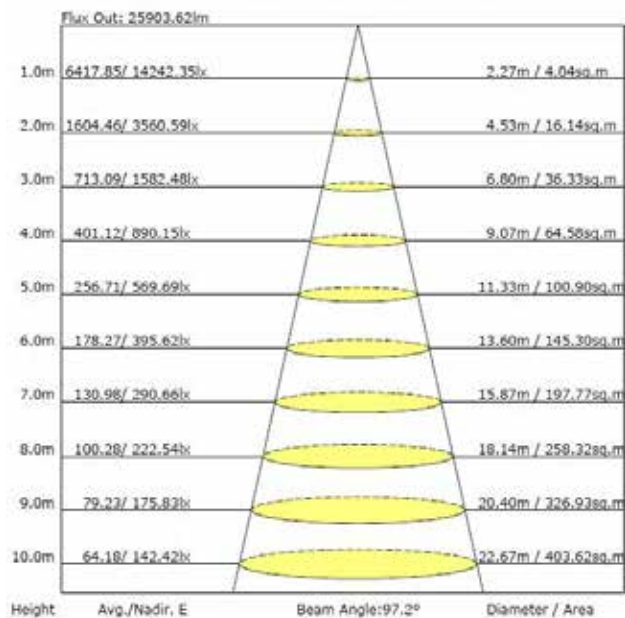

UFO HIGH BAY



BEYONDBEAM™

UFO High Bay

Installation

Cautions:

1. Do not use any electric generator to test the LED light.
2. Please abide by related country, regional and local law and regulations when installing this fixture.
3. Please turn off the power before installation or maintenance.
4. Proper earth grounding is required to ensure safety.

Notice:

1. To avoid possibility of electrical shock or fire, the installation personnel must have professional electric knowledge.
2. Please wear gloves to avoid injury before installation.
3. If any smoke or spark of the wire happened, please turn off the power immediately and notify relevant personnel.
4. Please use listed water proof strain relief bushing when connecting the supply cord to the outlet box.

Attention:

1. Please check if there is any damage during shipping. If so, please contact manufacturer timely.
2. Please read the installation instruction carefully to check whether all the accessories are complete. After confirmation, install the fixture according to installation steps.

Wiring Diagram & Instruction:

3 dimming functions are available in this high bay light:

1. Constant current can be achieved by 0-10V DC dimming;
2. PWM signal dimming;
3. Variation of resistance unit dimming.

Description:	
This product is 0/1-10V dimming, below dimmers are recommended:	
Brand	Model
LUTRON	NTSTV-DV
LEVITON	DS710-10Z / IP710
LEGRAND	RH4FBL3PW

Wiring Instruction:

ACL: Black/Brown, ACN: White/Blue, ⊕ Green/Yellow, DIM +: Purple, DIM -: Pink
(As for the wire color of DIM+ and DIM-, pls check the light label.)



Figure 1

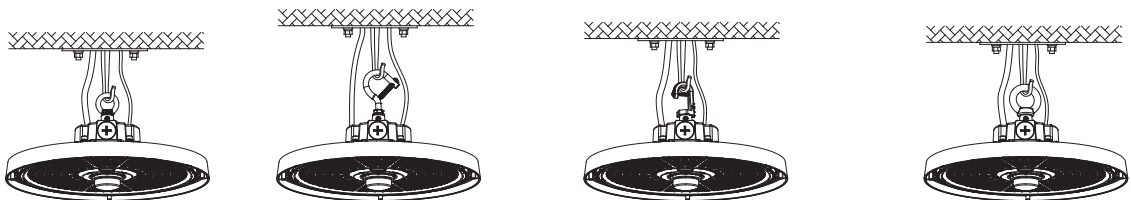

Figure 2



Installation

B. Ceiling Mount:

Step 1. Mark with a mark pen or sharp tool on the mounting surface and drill. (Figure 3)

Step 2. Fix screws into the holes with a hammer. (Figure 4)

Step 3. Align the bracket hole with screw hole (Figure 5), and push the fixture to one side (Figure 6) and fix it.

Step 4. After installation, connect the wire of the fixture to the mains according to local wiring rules, ensure the connection is stable and make good protection on the connection. By adjusting the brackets screws, users can adjust 50° to the left or right vertically. (Figure 7)

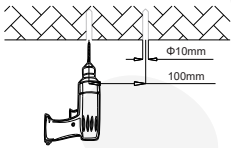

Figure 3

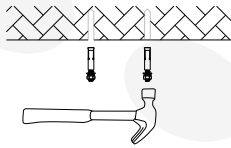

Figure 4

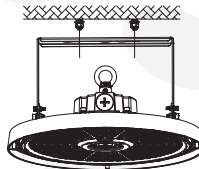

Figure 5

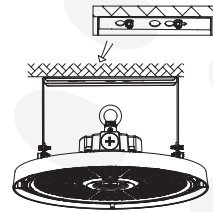

Figure 6

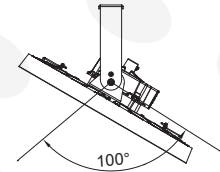

Figure 7

C. 1/2"NPT Mount:

Step 1. Unscrew the nuts on 1/2" NTP. (Figure 8)

Step 2. Insert 1/2" NTP stem into the bracket hole. (Figure 9)

Step 3. Re-screw the nuts. (Figure 10), After installation, connect the wire of the fixture to the mains according to local wiring rules, ensure the connection is stable and make good protection on the connection. By adjusting the brackets screws, users can adjust 50° to the left or right vertically.

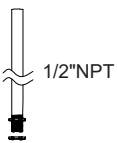

Figure 8

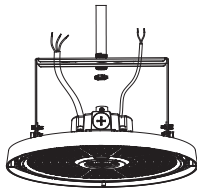

Figure 9

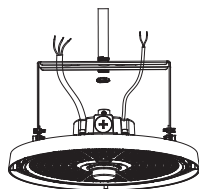
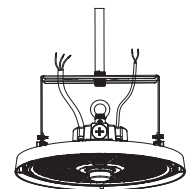

Figure 10



Extra Accessory Option Installation: 1:Wire Guard, 2:Motion Sensor / PIR Sensor, 3: Aluminum reflector/PC reflector 4: Safety cable:

1. **Wire Guard:** (Purchase the correct size wire guard from manufacturer)

Place the wire guard on the lamp and fix it with screws. (Figure 11)

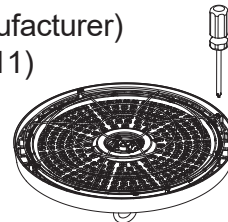

Figure 11



BEYONDBEAM™

UFO High Bay

Installation

2. DC Motion Sensor / PIR Sensor (Both sensors are with the same installation method)

Step 1. Use a screwdriver to remove the 1/2 plug from the sensor; (Figure 12)

Step 2. Twist-lock the DC sensor to the base to make it work properly, use a remote control to adjust the working mode as per demand. (Figure 13)

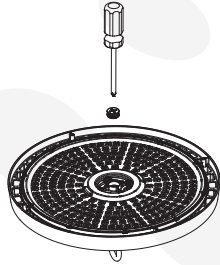

Figure 12

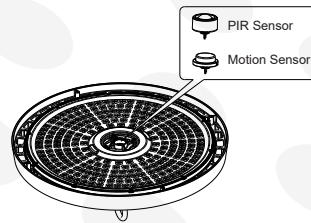

Figure 13

3: Aluminum reflector / PC reflector

Step 1. Lock the PC reflector or Aluminum reflector to the lamp with screws.

Step 2. Installation complete. (Figure 14)

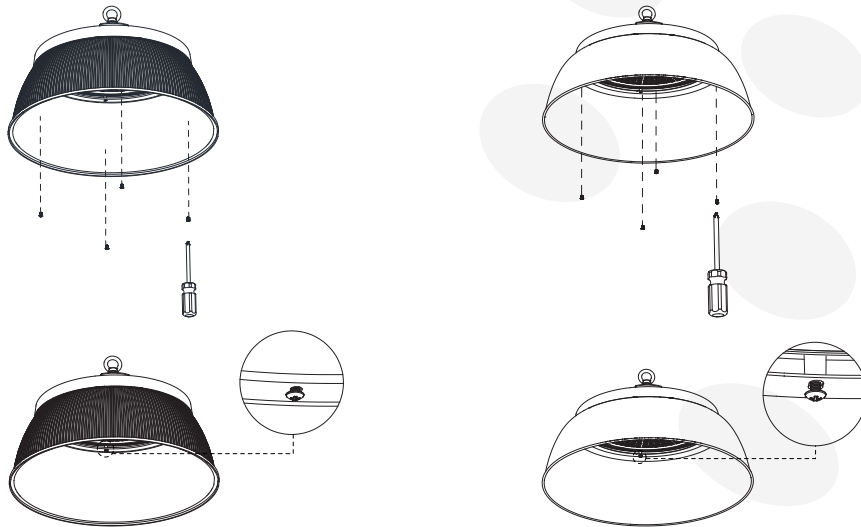

Figure 14



Installation

4: Safety cable:

Step 1. Fix the safety rope on the lamp body with screws. (Figure 15)

Step 2. Fix the safety buckle on the rail, and the installation is finished.

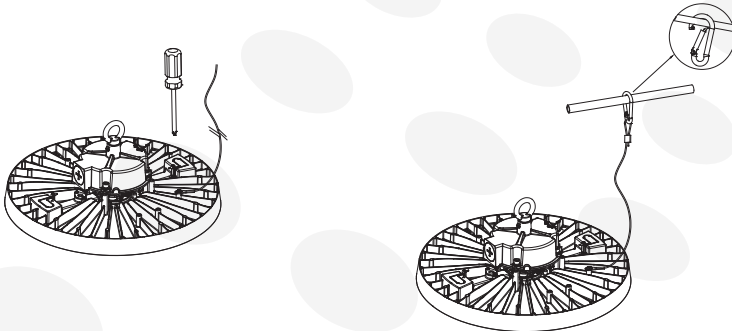

Figure 15

Optional Function:

This fixture is designed with integrated function of 3 CCT tunable, 3 wattage adjustable and 3 beam angle switchable, and the settings can be customized.

Operation: Remove the plug, adjust the switches as indicated to select the desired CCT, wattage or beam angle. Then screw the plug back after finished setting.

The original settings can be the factory default settings or be customized.

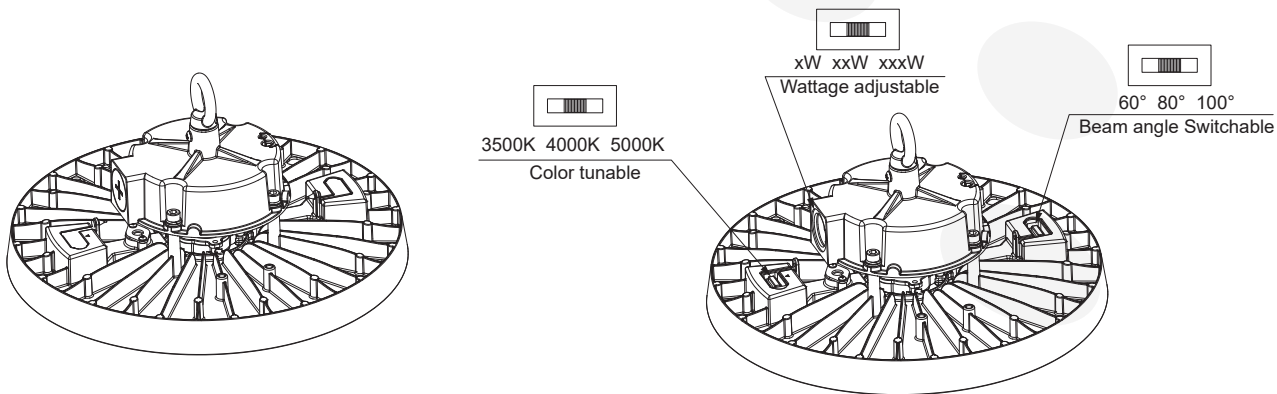



BEYONDBEAM™

UFO High Bay

Packaging

SKU	Box Dimension	Qty	Net Weight	Gross Weight
157063	16.54 x 16.54 x 6.50	1 PC/Box		10.58LBS

Application Image



UFO HIGH BAY

BEYONDBEAM™

UFO High Bay



Application Image



UFO HIGH BAY

Warranty

This product is covered under a 5-year warranty. For complete warranty details, [Click Here.](#)