



ORRA™

Architectural Flood Light



| SKU # | DLC Model # |
|--------|-----------------------------------|
| 156191 | AST-FLE01-80WB35DA1-abcdW30/40/50 |

| SKU # | Model # |
|--------|-----------------------------------|
| 157072 | AST-FLE01-80WB35DA1-abcdW30/40/50 |

The ORRA Architectural Floodlight by Beyond LED Technology offers advanced lighting solutions with two versatile models. The CCT adjustable model allows both wattage and color temperature (CCT) adjustments, with adjustable wattages of 40W, 60W, and 80W for optimal control. The RGB model, available in a 80W option, offers vibrant, customizable colors for accent lighting, signage, and special effects, controlled via the Tuya app and Bluetooth. Both models provide exceptional brightness and energy efficiency. Designed for durability with an IP65 rating, the ORRA is ideal for both commercial and residential applications, with a 35° beam angle for focused illumination of architectural features and landscapes.

Product Features

- Up to 155 lm/W
- Adjustable wattage (CCT model)
- RGB model: 80W with Bluetooth
- 35° Beam Angle
- Built-in photocell
- Built-in 10KV surge protector
- U-bracket included
- Bronze housing
- Input voltage 120-277V
- UL & DLC listed
- 5-year warranty



Architectural Flood Light

| SKU | ADJ. WATT | MAX LUMENS | ADJ. CCT | INPUT VOLTAGE | CRI | LIGHT SPREAD | CONSTRUCTION | BLUETOOTH | DIMMING | IP RATING | CERTIFICATIONS |
|--------|-----------------|------------|-------------------|---------------|-----|--------------|---|-----------|---------|-----------|----------------|
| 157042 | 40W/60W/80W | 12400 | 3000K/4000K/5000K | 120-277V | >80 | 35° | Die-cast Aluminum+ clear Tempered glass | No | 0-10V | IP65 | UL & DLC |
| 157072 | 80W Single Watt | RGBW | RGBW | 120-277V | >80 | 35° | | Yes | 0-10V | IP65 | UL |

SKU: 157042

Specifications

| Parameter | Description | Value |
|---------------------|-------------------------|-----------------------------------|
| General Performance | Model No. | AST-FLE01-80WB35DA1-abcdW30/40/50 |
| | Adjustable Watt | 40W / 60W / 80W |
| | Max Lumens | 12400 |
| | Lumen Efficacy | Up to 155LM/W |
| | Color Temperature | 3000K / 4000K / 5000K |
| | CRI (Ra) | >80 |
| | Light Spread | 35° |
| | Input Voltage | 120-277Vac |
| Electrical | Distribution Pattern | Clear Tempered Glass |
| | Frequency | 50/60Hz |
| | Dimming | 0-10V |
| | PF (Tolerance: -3%) | ≥0.9 |
| | THD (Tolerance : +5%) | ≤20% |
| | Flicker Percent | <5% |
| | Driver Brand | LIFUD |
| Driver Model | LF-FAA100 /LF-FAC100 | |
| Physical | Driver Surge Protection | L/N-PE: 6kV, L-N: 4kV |
| | Operating Temperature | -40°C TO 50°C |
| | Storage Temperature | -40°C TO 80°C |
| | Operating Humidity | 20% - 90% RH |
| | Storage Humidity | 20% - 90% RH |
| | LED Brand | Lumileds |
| | LED Type | 2835 |
| | LED QTY | 176 PCS |
| Construction | Die-cast aluminum | |
| Qualification | Housing Color | Bronze |
| | IP Rating | IP65 |
| | Warranty | 5 Year warranty |



ORRA™

Architectural Flood Light

SKU: 157072

Specifications

| Parameter | Description | Value |
|---------------------|-------------------------|-----------------------------------|
| General Performance | Model No. | AST-FLE01-80WB35DA1-abcdW30/40/50 |
| | Watt | 80W |
| | Max Lumens | RGB |
| | Lumen Efficacy | N/A |
| | Color Temperature | RGB |
| | CRI (Ra) | >80 |
| | Light Spread | 35° |
| | Input Voltage | 120-277Vac |
| Electrical | Distribution Pattern | Clear Tempered Glass |
| | Frequency | 50/60Hz |
| | Dimming | 0-10V |
| | PF (Tolerance: -3%) | ≥0.9 |
| | THD (Tolerance : +5%) | ≤20% |
| | Flicker Percent | <5% |
| | Driver Brand | LIFUD |
| | Driver Model | LF-FAA100 /LF-FAC100 |
| Physical | Driver Surge Protection | L/N-PE: 6kV, L-N: 4kV |
| | Operating Temperature | -40°C TO 50°C |
| | Storage Temperature | -40°C TO 80°C |
| | Operating Humidity | 20% - 90% RH |
| | Storage Humidity | 20% - 90% RH |
| | LED Brand | Lumileds |
| | LED Type | 2835 |
| | LED QTY | 176 PCS |
| Qualification | Construction | Die-cast aluminum |
| | Housing Color | Bronze |
| | IP Rating | IP65 |
| | Warranty | 5 Year warranty |



Architectural Flood Light

Correlated Color Temperature (CCT)

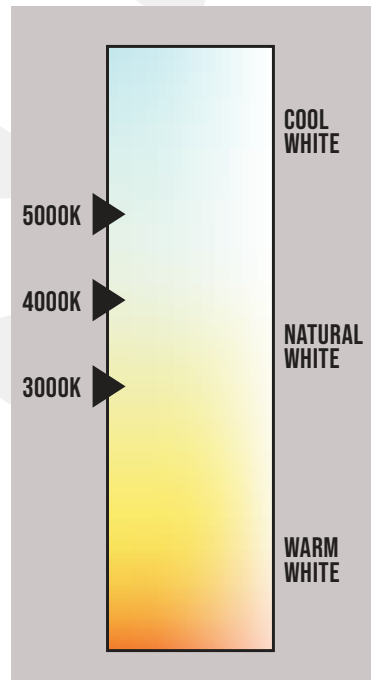

Dimensions

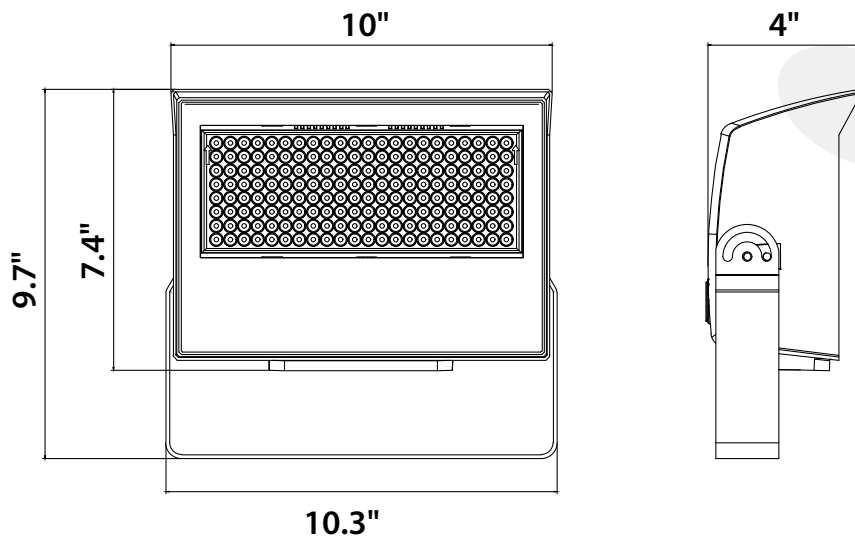



ORRA™

Architectural Flood Light

Correlated Color Temperature (CCT)

Luminaire Property

Luminaire Manufacturer:
 Luminaire Category:
 Lamp Catalog:
 Number of Lamps:
 Luminous Length (mm):
 Luminous Height (mm):
 Current: 0.658 A
 Power Factor: 0.999

Luminaire Description:
 Lamp Description:
 Lumens per Lamp:
 Luminous Width (mm):
 Voltage: 120.0 V
 Power: 78.83 W

Photometric Results

IES Classification: Type I
 Total Rated Lamp Lumens: 11558.2 lm
 Efficiency: 100%
 Upward Ratio: 0%
 C0r0 Intensity: 5697.13 cd
 Pos of Max. Intensity: H202.5 V10
 Beam Angle(C0/C180,C90/C270,C45/C225,C135/315): 93.7, 87.3, 94.3, 94.4

Longitudinal Classification: Very Short
 Measurement Flux: 11558.2 lm
 Downward Ratio: 100%
 Luminaire Efficacy Rating (LER): 146.67
 Max. Intensity: 5730.67 cd

Luminous Intensity Distribution Curve

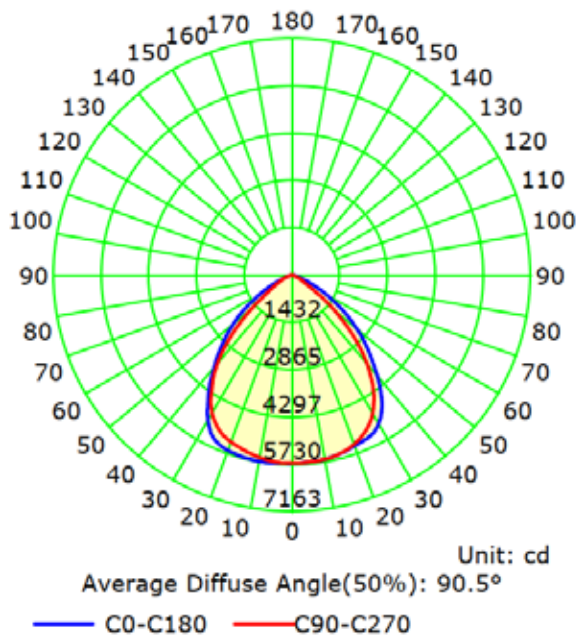

The Average Illuminance Effective Figure

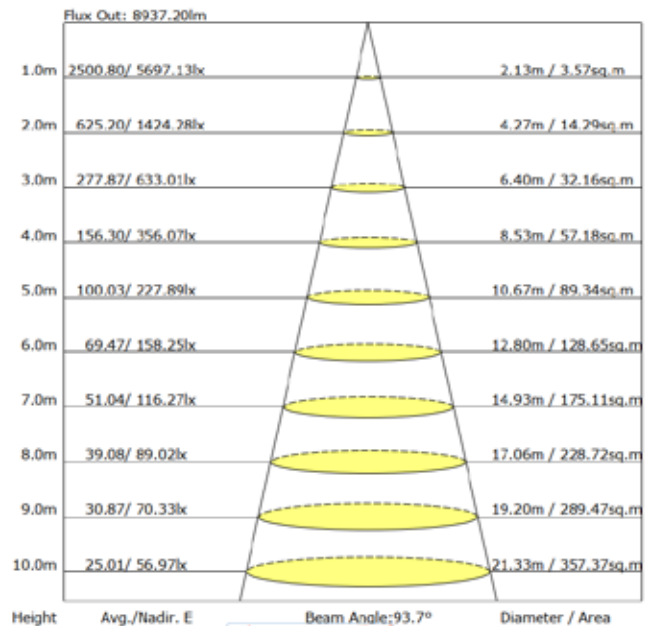



Installation

Cautions:

1. Do not use an electric generator to test LED fixtures.
2. Please abide by related country, regional and local law and regulations when install this fixture.
3. Please turn off the power before installation or maintenance.
4. Proper earth grounding is required to ensure safety.

Notice:

1. To avoid possibility of electrical shock or fire, the installation personnel must have professional electric knowledge.
2. Please wear gloves to avoid injury before installation.
3. If any smoke or spark of the wire happened, please turn off the power immediately and notify relevant personnel.

Attention:

1. Please check if there is any damage during shipping. If so, please contact manufacturer timely.
2. Please read the installation instruction carefully to check whether all the accessories are complete. After confirmation, then install the fixture according to installation steps.

Instructions:

1. This product has dimming function.
2. 2 dimming functions are available in this LED light:
 - (1). Constant current can be achieved by 0-10VDC dimming.
 - (2). Variation of resistance unit dimming(Please choose the appropriate dimming way according to your needs. You can also choose not to use this function).

Wiring Diagram:

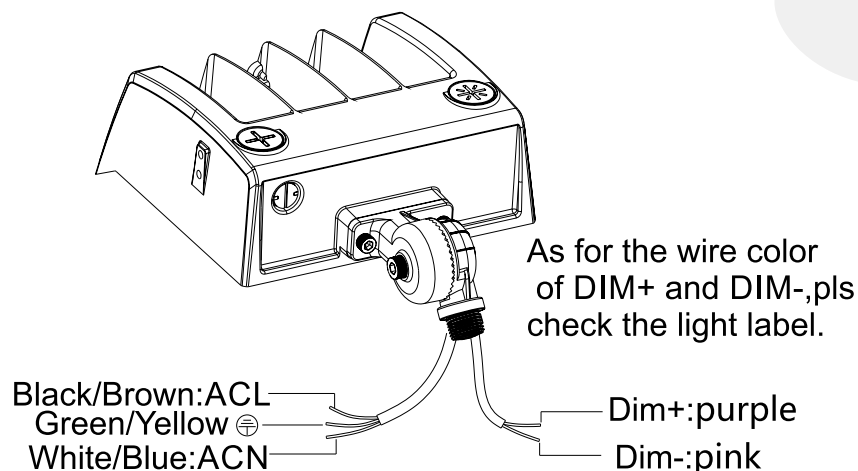



ORRA™

Architectural Flood Light

Installation

Brackets and Installation Instructions

1. There is U-Bracket for this fixture. The following is flood fixtures with U-Bracket.

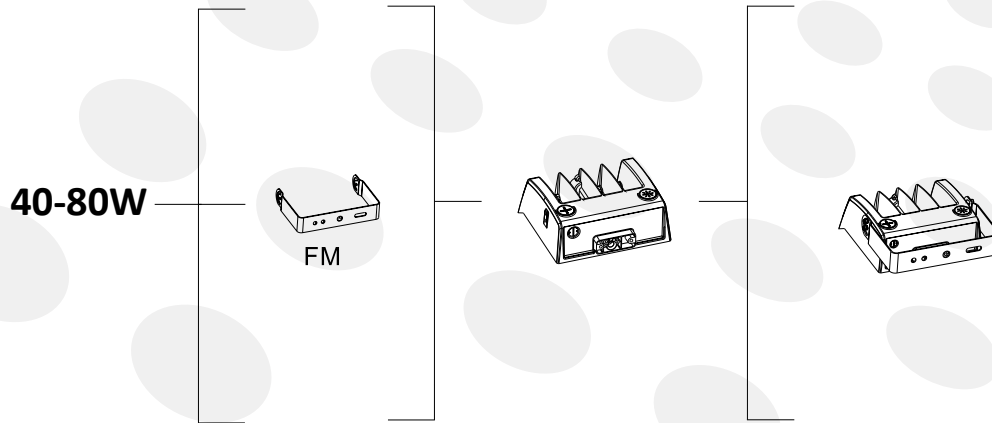

Installation 1. U-Bracket

Installed with U-Bracket (suitable for all power of this fixture)
(suitable for 40W, 60W, 80W)

Step 1: Take the lamp out of package. (figure 1.1)

Step 2: Tighten the brackets and screws. (figure 1.2)

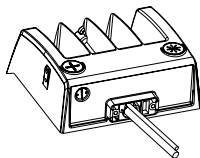

(figure 1.1)

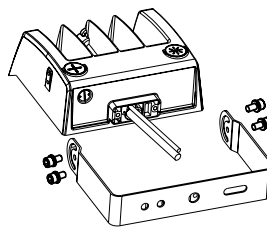

(figure 1.2)

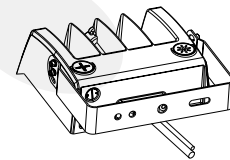

Installed with whole fixture (suitable for all power of this fixture)

Step 1: Take the fixture out of package.

Step 2: Finish the wire connection according to the right mode of connection (pay attention to positive wire, negative wire, and ground wire). (figure 1.3)

Step 3: Loosen screw; Adjust fixture angles as per actual demands and tighten screws later. (figure 1.4), Tips: Angles of the fixture is adjustable



Installation

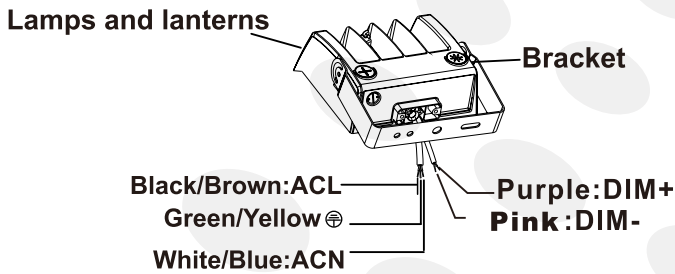

figure 1.3

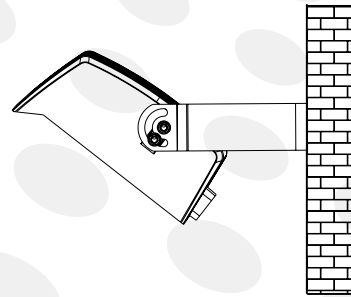

figure 1.4

Installation 2: Function adjustment

Step 1: Open the metal plug and plastic plug counterclockwise with a screwdriver

Step 2: (figure 6.1), then slide the switch up and down to adjust the power controller, CCT controller or photocell controller in your demand. (figure 6.2)

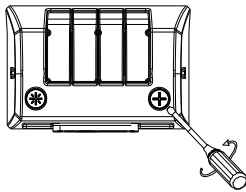

figure 2.1

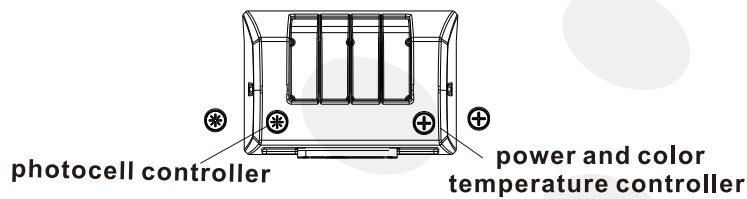

figure 2.2

Step 3: After adjusting the required control function (figure 2.3), tighten the metal plug and the plastic plug clockwise (figure 2.4).

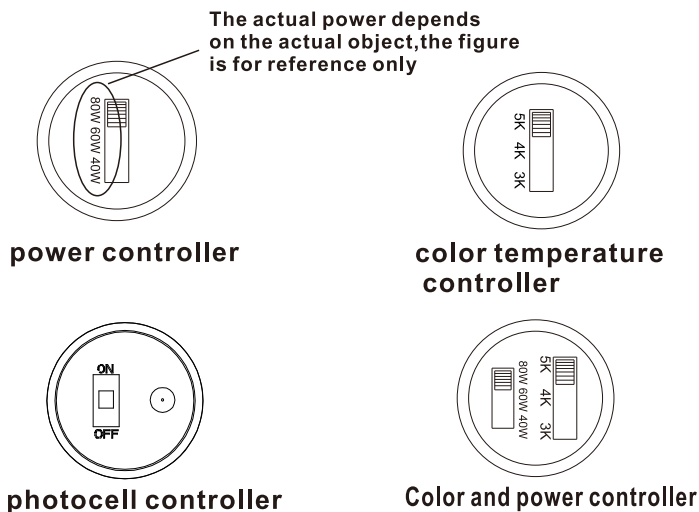

figure 2.3

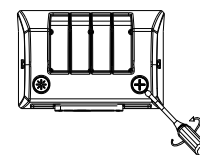

figure 2.4



ORRA™

Architectural Flood Light

Installation

Installation 3: Optical Angle adjustment

1. Take the lamp out of the packing box, take out the handle configured in the packing box and insert it into the slot of the knob. (figure 3.1)
2. Adjust the handle to the desired Angle by turning it left and right, as shown in the picture. (figure 3.2)



figure 3.1

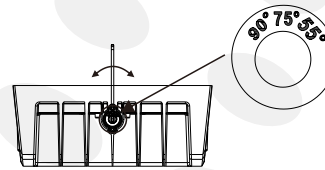

figure 3.2

- Please turn off power before install or change assembly parts.
- The input voltage and lamps should be matched, after connecting the power line, Please make sure the wiring section is insulated.
- No-professionals, must not install and disassemble the lamps.

Troubleshooting

| Troubles | Check Points |
|-------------------------|--|
| Flickering of the light | Turn off the power and turn on again in 3 minutes. If same phenomena occur, then call agencies. |
| Not Working | Please check the connection |



Packaging

| SKU | Box Type | Box Dimension | Qty | Net Weight | Gross Weight |
|--------|----------|--------------------------|-----------|------------|--------------|
| 157042 | Inner | 12.40" x 5.11" x 13.58" | 1 PC/Box | | |
| 157042 | Outer | 26.38" x 12.80" x 14.17" | 5 PCS/Box | | |
| 157072 | Inner | 12.40" x 5.11" x 13.58" | 1 PC/Box | | |
| 157072 | Outer | 26.38" x 12.80" x 14.17" | 5 PCS/Box | | |

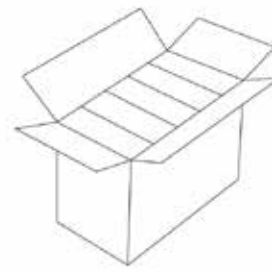
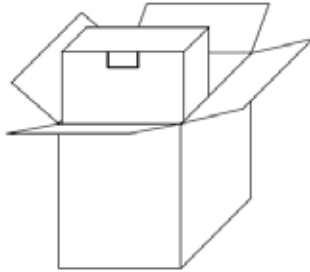
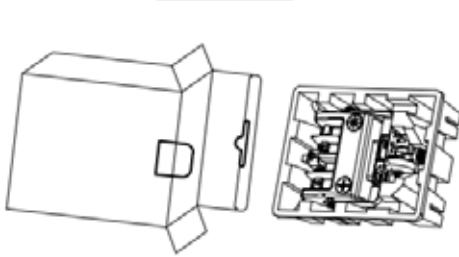



ORRA™

Architectural Flood Light

Application Image



Warranty

This product is covered under a 5-year warranty. For complete warranty details, [Click Here.](#)