

Mechanical Dimensions (mm)

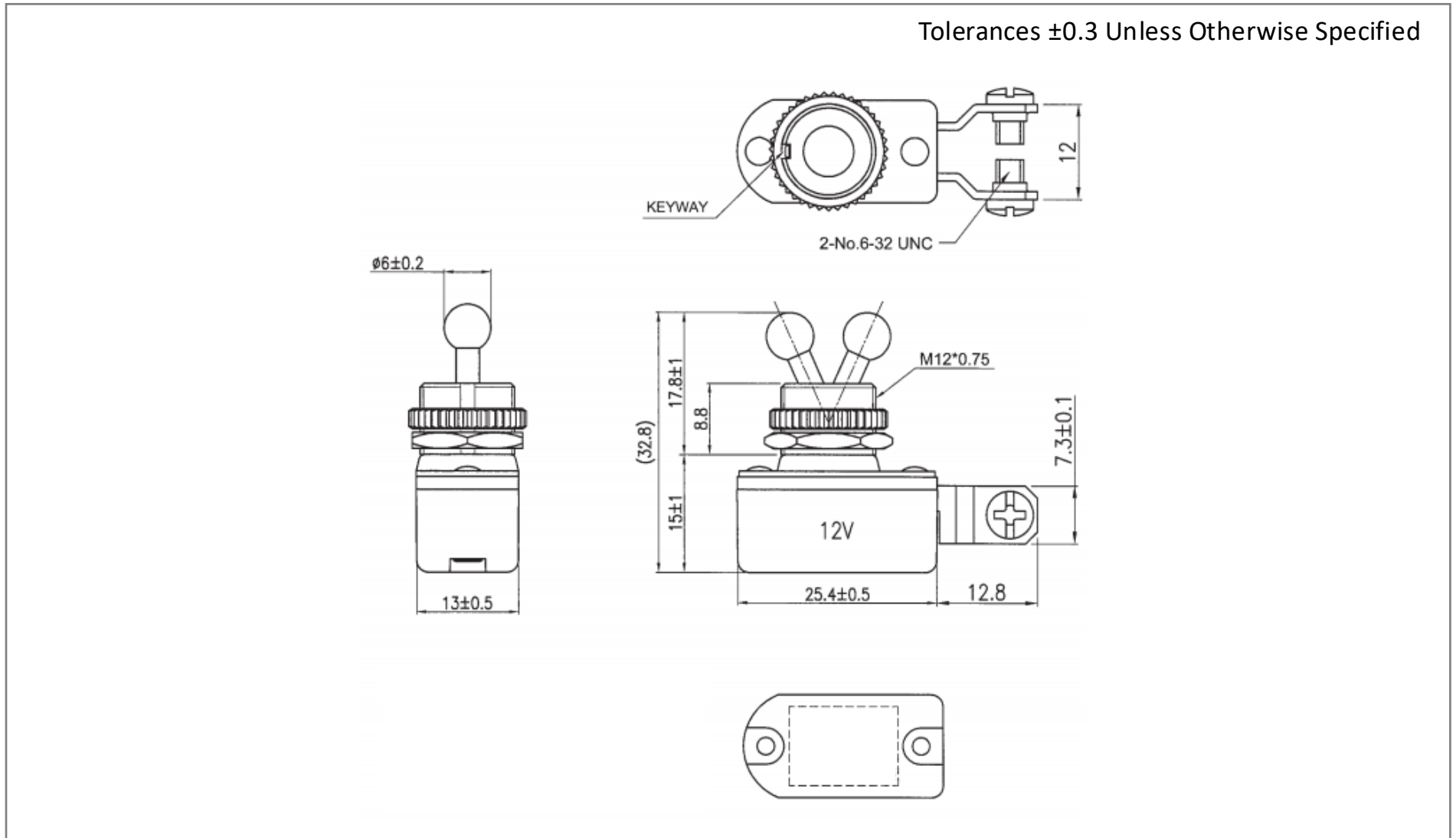

Mounting Hole

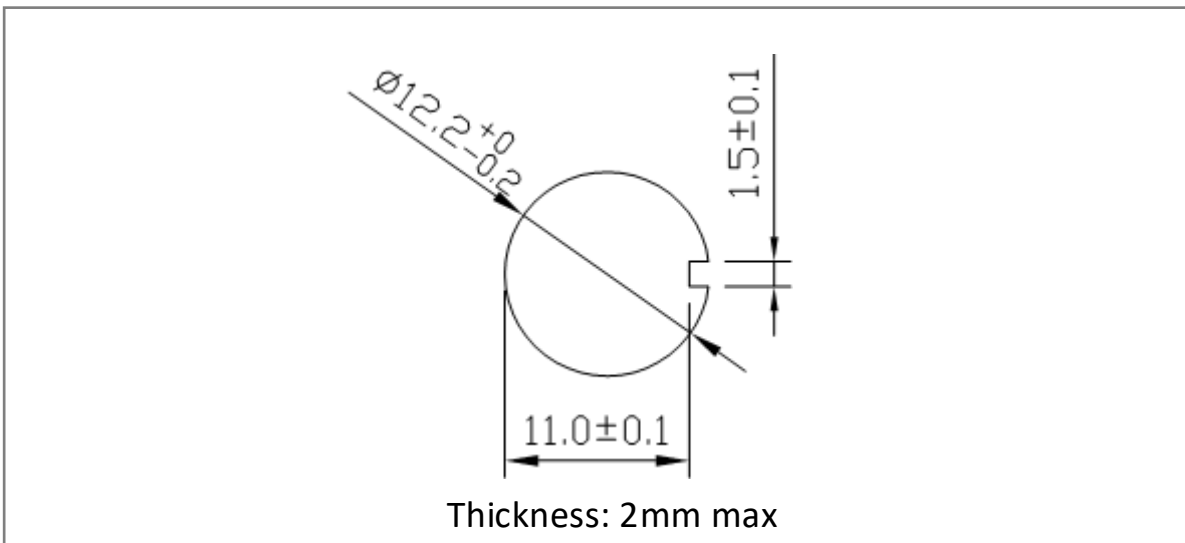

Circuit Diagram

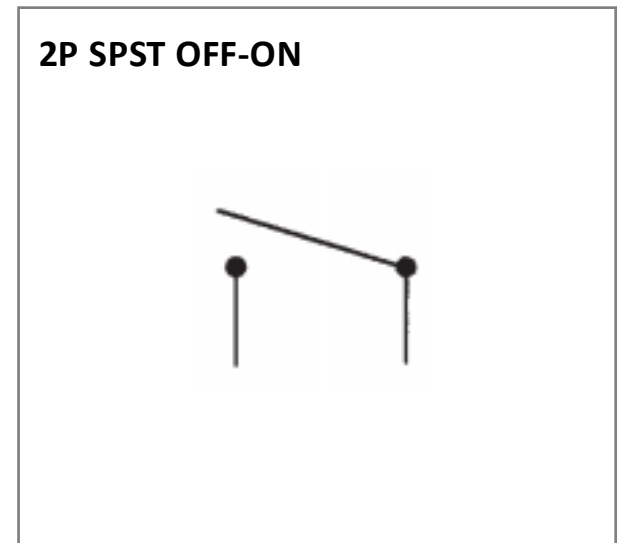

Electrical Specifications

Rating	10A 12VDC
Contact Resistance	50m ohm Max.
Insulation Resistance	DC 500V 100M ohm Min.
Dielectric Strength	AC 1000V 1 minute

Material Specifications

1 HEX NUT ASSY
1 KNURL NUT ASSY