

PRODUCT SPECIFICATIONS

Quartz Classic[®] 15-3/4" x 15-3/4" x 7-11/16" Single Bowl Dual Mount Bar Sink Kit. Sink is molded with up to 80% natural quartz and high performance acrylic resins that are non-porous providing superior heat, scratch, fade and stain resistance. Naturally sound deadening and Rear Center drain placement.

Installation Type:	Drop-in, Sink Kits, Undermount
Material:	Quartz
Finish:	Black (BK), Graphite (GT), Matte Black (MB), White (WH)
Number of Bowls:	1
Sink Dimensions:	15-3/4" x 15-3/4" x 7-11/16"
Bowl 1 Dimensions:	13-1/8" x 13-1/8" x 7-11/16"
Drain Size:	3-1/2" (89mm)
Drain Location:	Rear Center
Minimum Cabinet Size:	21"
Mounting Hardware:	Part # 64090404 included for top mount installation for countertops up to 1-3/4" (44mm) thick. Part # 54300404 included for undermount installation.
Template Included:	Yes
Cutout Template #:	1000003495_undermount 1000003497_topmount

Template is available for download at elkay.com. CAD software will be required to open the template.

Cutout Dimensions for Drop-in Installation:

15-1/8" x 15-1/8" (384mm x 384mm) with 3/8" (10mm) corner radius



Graphite (GT) Matte Black (MB) White (WH)



Included with Product: LKOBG1616SS Bottom Grid, LKQS35 Strainer, LKCLKIT Cleaning Kit

▼ **Ships in multiple boxes.**

A Century of Tradition and Quality. For more than 100 years, Elkay has been making innovative products and providing exceptional customer care. We take pride in offering plumbing products that make life easier, inspire change and leave the world a better place.



Product Compliance: CSA B45.5/IAPMO Z124
Accessory: ASME A112.18.2/CSA B125.2

[Clean and Care Manual \(PDF\)](#)
[Installation Instructions \(PDF\) - 1000005238](#)
[Warranty \(PDF\)](#)

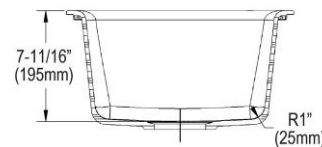
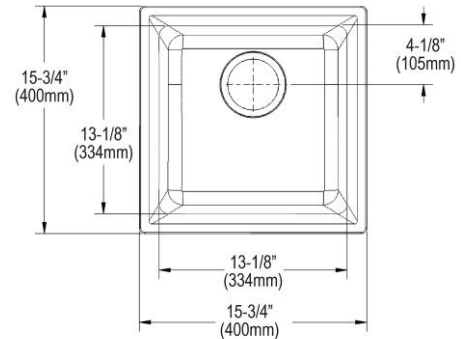





PART: _____ QTY: _____
PROJECT: _____
CONTACT: _____
DATE: _____
NOTES: _____
APPROVAL: _____

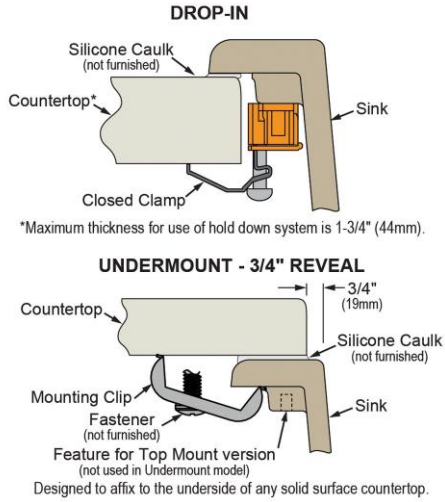

In keeping with our policy of continuing product improvement, Elkay reserves the right to change product specifications without notice. Please visit elkay.com for the most current version of Elkay product specification sheets. This specification describes an Elkay product with design, quality, and functional benefits to the user. When making a comparison of other producers' offerings, be certain these features are not overlooked. Latest version of the spec sheet available: https://www.elkayfiles.com/spec-sheets/ELG1616C_spec.pdf

Installation Profile:



Included Accessories		
LKCLKIT	Sink Cleaning Kit Spec Sheet (PDF)	
LKOBG1616SS	Stainless Steel 11-1/2" x 11-1/2" x 1" Bottom Grid Spec Sheet (PDF)	
LKQS35	Elkay® Polymer 3-1/2" Drain Fitting with Removable Basket Strainer and Rubber Stopper Spec Sheet (PDF)	
Optional Accessories		
LKQD35	Polymer 3-1/2" Disposer Flange with Removable Basket Strainer and Rubber Stopper Spec Sheet (PDF)	
LKQS35	Elkay® Polymer 3-1/2" Drain Fitting with Removable Basket Strainer and Rubber Stopper Spec Sheet (PDF)	
LKW RB1209SS	Stainless Steel 8" x 11" x 7" Rinsing Basket Spec Sheet (PDF)	

In keeping with our policy of continuing product improvement, Elkay reserves the right to change product specifications without notice. Please visit elkay.com for the most current version of Elkay product specification sheets. This specification describes an Elkay product with design, quality, and functional benefits to the user. When making a comparison of other producers' offerings, be certain these features are not overlooked. Latest version of the spec sheet available: https://www.elkayfiles.com/spec-sheets/ELG1616C_spec.pdf

<p>LKQD35</p>	<p>Polymer 3-1/2" Disposer Flange with Removable Basket Strainer and Rubber Stopper Spec Sheet (PDF)</p>	
<p>LKQS35</p>	<p>Elkay® Polymer 3-1/2" Drain Fitting with Removable Basket Strainer and Rubber Stopper Spec Sheet (PDF)</p>	

In keeping with our policy of continuing product improvement, Elkay reserves the right to change product specifications without notice. Please visit elkay.com for the most current version of Elkay product specification sheets. This specification describes an Elkay product with design, quality, and functional benefits to the user. When making a comparison of other producers' offerings, be certain these features are not overlooked. Latest version of the spec sheet available: https://www.elkayfiles.com/spec-sheets/ELG1616C_spec.pdf