



Welcome

Congratulations on your purchase of this Sony VAIO® computer, and welcome to the online VAIO® Computer User Guide. This user guide provides detailed information on all aspects of using your new VAIO computer, from keyboard functions to preinstalled software programs.

In the left navigation window, click the topics you want to learn more about, and that information will be displayed in this main window.

 View the [Electronic Flyer](#), which provides updates and supplemental information about your computer.

 Go to the [Sony Computing Support](#) Web site to view the VAIO® Computer Specifications, which list your computer's hardware specifications and preinstalled software information.

 For Sony software information, click **Start** and select **Welcome to VAIO life**.

Ergonomics and Caring for Your Computer

This section provides information on how to safely use your Sony computer.

- [Applying Ergonomics](#)
- [Storing Your Computer](#)
- [Cleaning Your Computer](#)
- [Handling the LCD Screen](#)

Applying Ergonomics

Your computer is a portable device and can be used in a variety of environments. Whenever possible, you should apply the following ergonomic considerations:

- **Position of your computer** — Place the computer directly in front of you as you work. Keep your forearms horizontal, with your wrists in a neutral, comfortable position while using the keyboard, touch pad, or external mouse. Let your upper arms hang naturally at your sides. Take breaks during sessions with your computer. Excessive use of the computer may strain muscles or tendons.
- **Furniture and posture** — Sit in a chair with good back support and armrests. Adjust the level of the chair so your feet are flat on the floor. A footrest may make you more comfortable. Sit in a relaxed, upright posture and avoid slouching forward or leaning far backward.
- **Viewing angle of the computer's display** — Tilt the display to find the best viewing angle. Also try adjusting the brightness setting of the display. Following these suggestions can reduce eye strain and muscle fatigue.
- **Lighting** — Choose a location where windows and lights do not create glare or reflection on the display. Use indirect lighting to avoid bright spots on the display. You can purchase accessories for your display that help reduce glare. Proper lighting adds to your comfort and work effectiveness.
- **Placement of an external display** — When using an external display, set the display at a comfortable viewing distance. Make sure the display screen is at eye level or slightly lower when you are sitting in front of the monitor.

Storing Your Computer

- Do not use or store your computer in a location subject to:
 - Heat sources, such as radiators or air ducts
 - Direct sunlight
 - Excessive dust
 - Moisture or rain
 - Mechanical vibration or shock
 - Strong magnets or speakers that are not magnetically shielded
 - Ambient temperature higher than 95°F (35°C) or less than 40°F (5°C)
 - High humidity
- Do not place electronic equipment near your computer. When running, the computer's electromagnetic field may cause other electronic equipment in close proximity to malfunction.
- Provide adequate air circulation to prevent internal heat buildup. Do not place your computer on porous surfaces such as rugs or blankets, or near materials such as curtains or draperies that may block ventilation. Leave a space of at least 8 inches (20 cm) behind the back of the computer.
- If the computer is brought directly from a cold location to a warm one, moisture may condense inside your computer. In this case, allow at least one hour before turning on your computer. If any problems occur, unplug your computer, and contact your Sony Service Center.
- The computer uses high-frequency radio signals and may interfere with radio or TV reception. Should this occur, move the computer a suitable distance away from the radio or TV.
- Do not drop the computer or place heavy objects on top of the computer.

Using Cables and Connections

- Use only specified peripheral equipment and interface cables.
- Do not use cut or damaged connection cables.
- If the telephone company makes a service call to your home or office and determines that your computer is responsible for a problem, the telephone company may bill you for the service call. Also, if you do not disconnect your computer when it is adversely affecting a telephone line, the telephone company has the right to disconnect your service until you correct the problem.

Cleaning Your Computer

- Clean the computer with a soft, dry cloth or a soft cloth lightly moistened with a mild detergent solution. Do not use any type of abrasive pad, scouring powder, or solvent such as alcohol or benzine, as these may damage the finish of your computer. You can use canned compressed air specifically for computers to remove dust.
- If a solid object falls onto the computer or a liquid leaks into the computer, immediately turn off and unplug the computer. It is best to have the computer checked by qualified personnel before you use it again.
- Avoid rubbing the LCD screen as this can damage the screen. Use a soft, dry cloth to wipe the LCD screen or canned compressed air.
- Always disconnect the power cord before cleaning the computer.

Handling the LCD Screen

- Direct sunlight can damage the LCD. Be careful when using the computer near a window.
- Do not scratch the LCD or exert pressure on it. This can cause a malfunction.
- Using the computer in low temperature conditions may produce a residual image on the screen. This is not a malfunction. When the computer returns to normal temperature, the screen returns to normal.
- The screen becomes warm during operation. This is normal and does not indicate a malfunction.
- The LCD is manufactured using high-precision technology. You may, however, see tiny black points and/or bright points (red, blue, or green) that continuously appear on the LCD. This is a normal result of the manufacturing process and does not indicate a malfunction.

Locating Controls and Ports

Congratulations on your purchase of the Sony® VAIO® computer. Sony has combined leading-edge technology in audio, video, computing, and communications to provide state-of-the-art personal computing.

Front

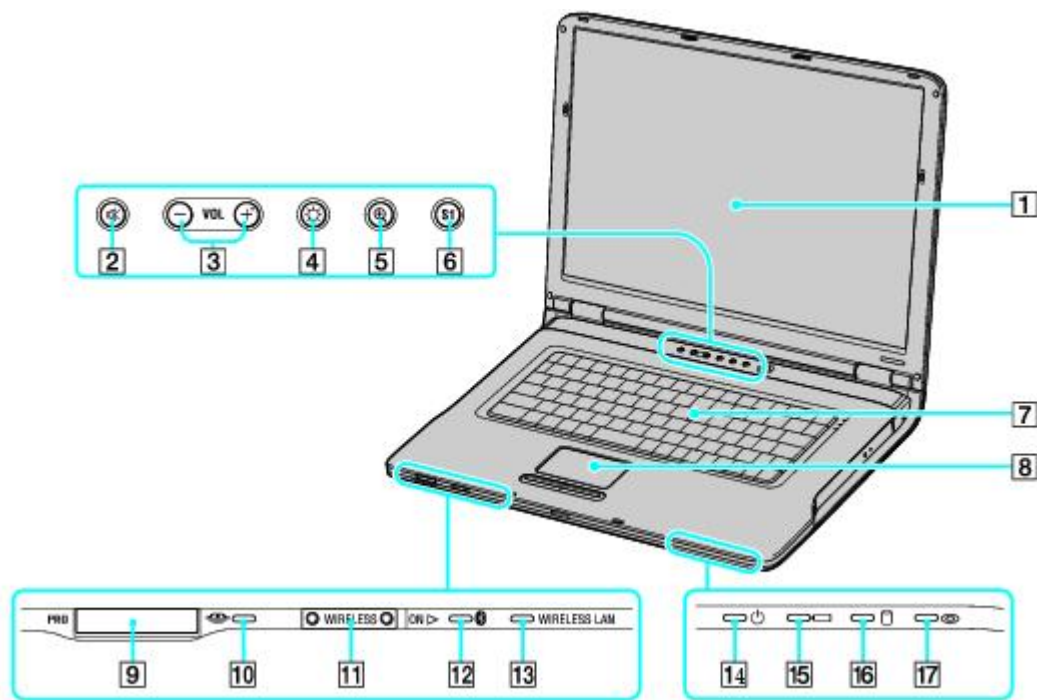

1 LCD screen **10** Memory Stick® media indicator

2 Mute button

11 Wireless switch¹

3 Volume buttons

12 Bluetooth® indicator¹

4 Brightness button

13 Wireless indicator¹

5 Magnify screen button

14 Power indicator

6 S1 button

15 Battery indicator

7 Keyboard

16 Hard disk drive indicator

8 Touch pad

17 Optical drive indicator

9 Memory Stick® media slot²

¹ Wireless LAN and Bluetooth functionality available on selected models only.

² Your computer supports Memory Stick Duo™ media and Memory Stick PRO™ high speed and high capacity capabilities.



Do not insert more than one Memory Stick media into the Memory Stick media slot as it may damage the computer.

Insert the Memory Stick media with the arrow facing up and toward the slot. Inserting the media improperly may damage the computer.

Front

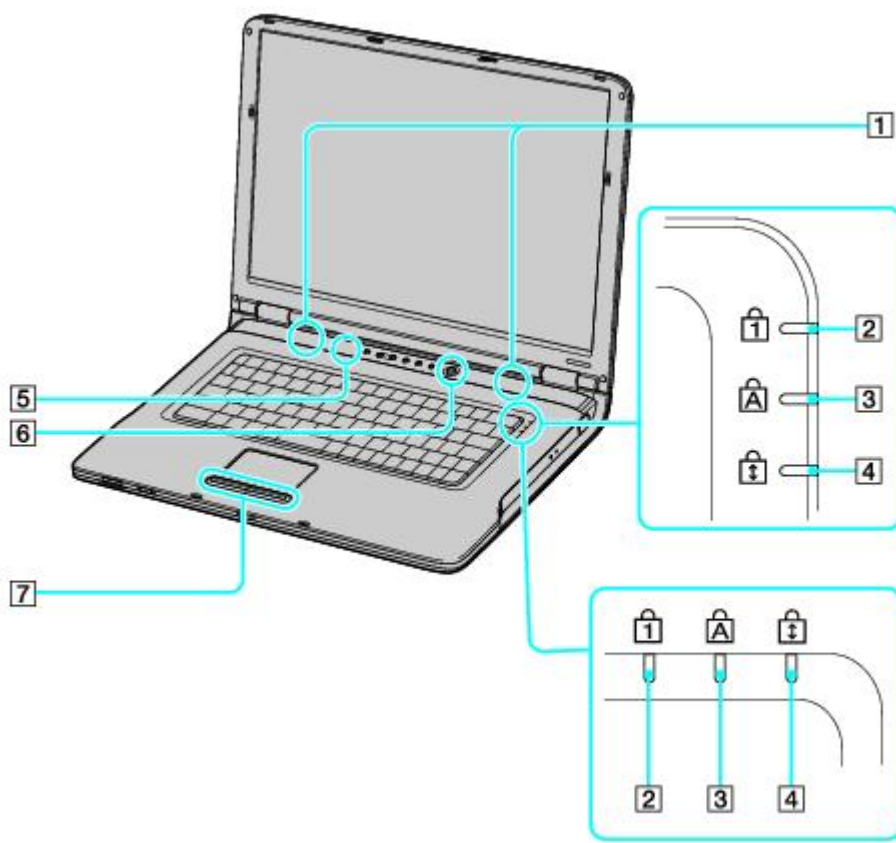

- 1 Speakers
- 2 Num lock indicator¹
- 3 Caps lock indicator¹
- 4 Scroll lock indicator¹
- 5 Brightness sensor
- 6 Power button
- 7 Left and right buttons

¹Indicator appears on the top or right corner of the keyboard depending on the model that you purchased.

Back

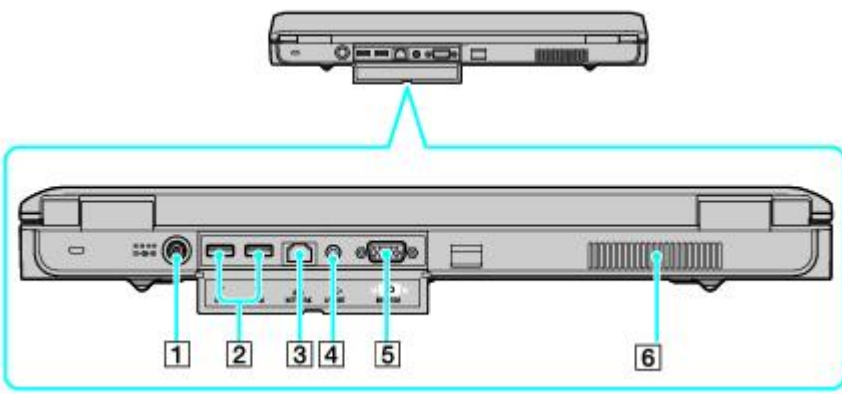

- 1 DC In port
- 2 USB 2.0 ports¹
- 3 Network (Ethernet) port
- 4 AV Out jack
- 5 Monitor (VGA) port
- 6 Air vent

¹ Supports high-/full-/low- speeds.

⚠ Only connect 10BASE-T, 100BASE-TX, 1000BASE-TX cables to the  Network (Ethernet) port. Do not connect any other type of network cable or any telephone line to this port. Connecting cables other than those listed above may result in an electric current overload and could cause a malfunction, excessive heat, or fire in the port. To connect the unit to a network, refer to your on-screen VAIO® Computer User Guide or contact your network administrator.

 Only selected models support a 1000BASE-TX connection.

Left

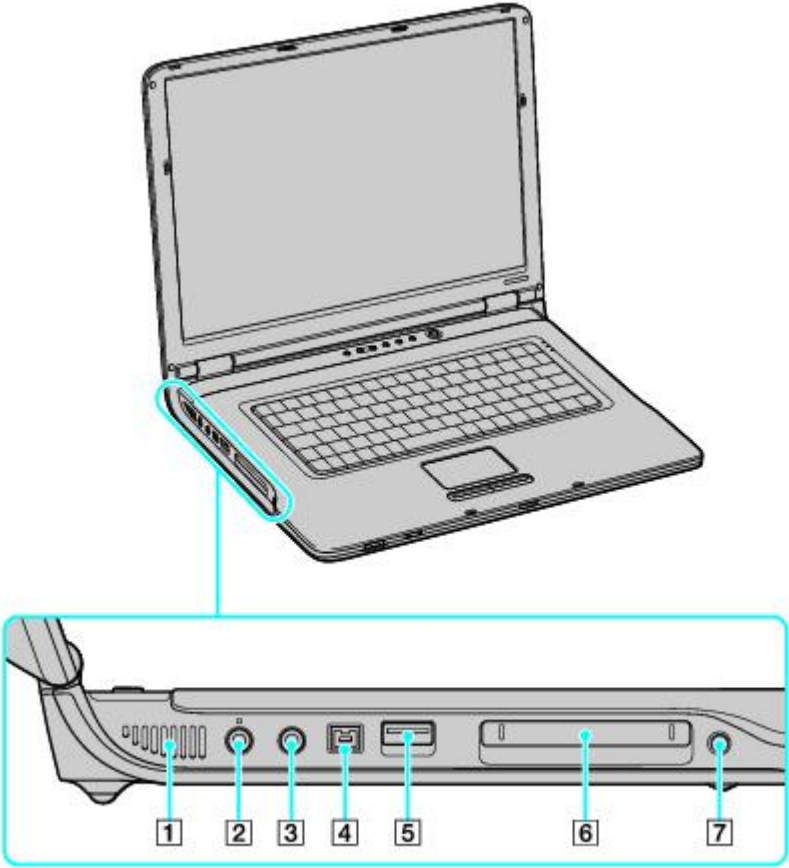

- 1** Air vent **5**  USB 2.0 port¹
- 2**  Microphone jack **6** PC Card slot
- 3**  Headphone jack **7** PC Card eject button
- 4**  i.LINK® (IEEE 1394) S400 port

¹ Supports high-/full-/low- speeds.

Right

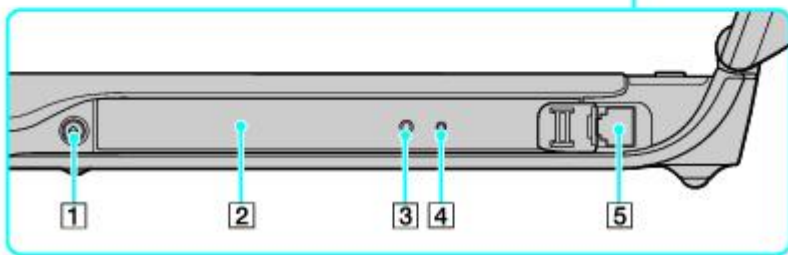
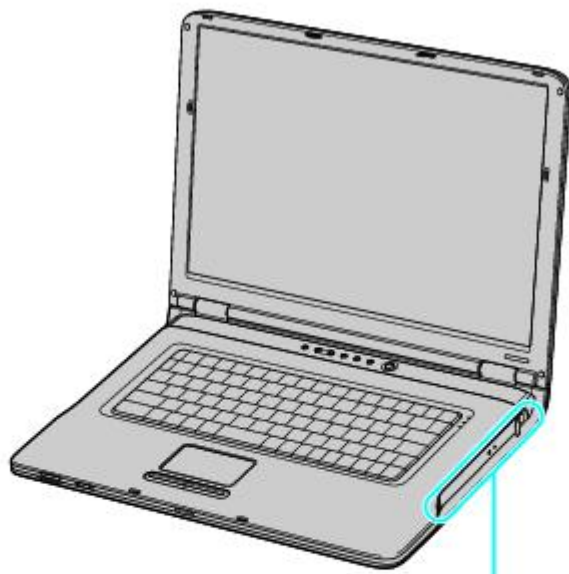

- 1 Drive eject button
- 2 Optical drive
- 3 Drive eject button
- 4 Manual eject hole
- 5 Modem jack

You can use either drive eject button to eject the optical drive tray. The drive eject button located next to the optical drive functions only with Microsoft® Windows® operating system.

Bottom

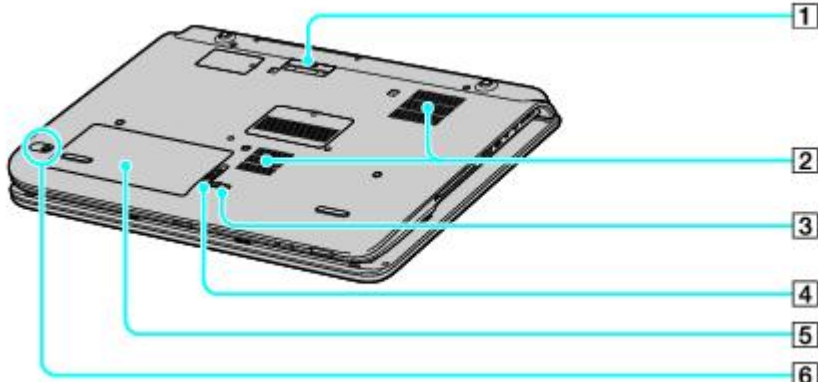

- 1 Port replicator connector
- 2 Air vents
- 3 LOCK/UNLOCK switch
- 4 RELEASE switch
- 5 Battery bay
- 6 CONNECT button¹

¹ On selected models with wireless mouse functionality.

See [Connecting a Wireless Mouse](#) for more information about using the wireless optical mouse.

The printer port on this port replicator is intended for printer connections only.

A/V Port Replicator

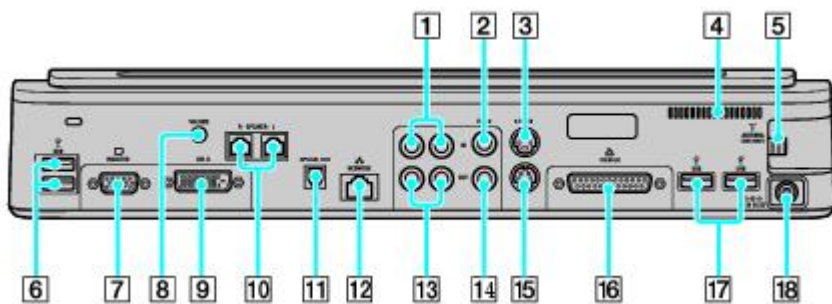

- 1** Composite Audio In jacks **10** Speaker jacks (right and left)
- 2** Composite Video In jack **11** Optical Out port
Output frequency (48 kHz¹/44 kHz)
- 3** S Video In port **12** Network (Ethernet) port (10BASE-T / 100BASE-TX / 1000BASE-TX²)
- 4** Air vent **13** Composite Audio Out jacks
- 5** VHF/UHF port **14** Composite Video Out jack
- 6** USB 2.0 ports³ **15** S Video Out port
- 7** Monitor (VGA) port **16** Printer port
- 8** Volume jack **17** USB 2.0 ports³
- 9** DVI-D port **18** DC IN port

¹ Output frequency is 48 kHz for all frequencies except 32 kHz and 44.1 kHz.



² Only selected models support a 1000BASE-TX connection.

³ Supports high-/full-/low- speeds.

The printer port on this port replicator is intended for printer connections only.

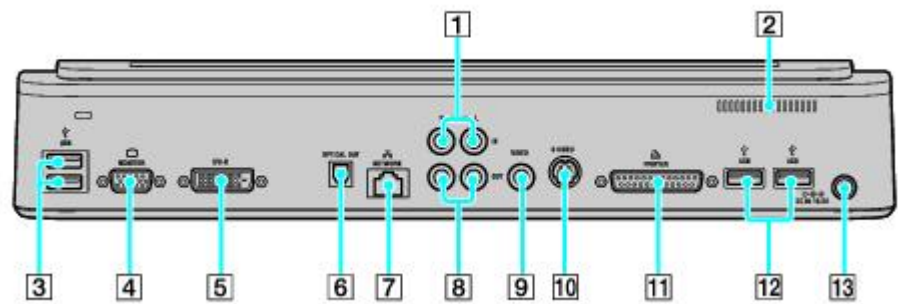
Business Port Replicator



- | | | | |
|----------|-------------------------------------------------------------------------------------------------------------|-----------|--------------------------------------------------------------------------------------------------------------|
| 1 | Composite Audio In jacks | 8 | Composite Audio Out jacks |
| 2 | Air vent | 9 | Composite Video Out jack |
| 3 |  USB 2.0 ports ¹ | 10 | S Video Out port |
| 4 | Monitor (VGA) port | 11 | Printer port |
| 5 | DVI-D port | 12 |  USB 2.0 ports ¹ |
| 6 | Optical Out port
Output frequency (48 kHz ² /44 kHz) | 13 | DC IN port |
| 7 | Network (Ethernet) port (10BASE-T / 100BASE-TX / 1000BASE-TX ³) | | |

¹ Supports high-/full-/low- speeds.

² Output frequency is 48 kHz for all frequencies except 32 kHz and 44.1 kHz.

³ Only selected models support a 1000BASE-TX connection.

About the Indicator Lights

Indicator Function

Power



Turns on when the power to the computer is on, blinks in Standby mode, and turns off when the computer is in Hibernate mode or off.

Battery



Turns on when the computer is using battery power, blinks when the battery is running out of power, double-blinks when the battery is charging.

Memory Stick®



Turns on when data is read from or written to the Memory Stick media. (Do not enter Standby mode or turn off the computer when this indicator is on.) When the indicator is off, the Memory Stick media is not being used.

Hard Disk



Turns on when data is read from or written to the hard disk. Do not enter Standby mode or turn off the computer when this indicator is on.

Num Lock



Press this key to activate the numeric keypad. Press it a second time to deactivate the numeric keypad. The numeric keypad is not active when the indicator is off.

Caps Lock



Press this key to type letters in uppercase. Letters appear in lowercase if you press Shift while the indicator is on. Press the key a second time to turn off the indicator. Normal typing resumes when the Caps Lock indicator is off.

Scroll Lock



Press this key to change how you scroll the display. Normal scrolling resumes when the Scroll Lock indicator is off. The Scroll Lock key functions differently depending on the program you are using and does not work with all programs.

Bluetooth®¹ Turns on when the wireless switch is set to ON and Bluetooth technology is enabled.

Wireless

LAN* Turns on when the wireless LAN function is running.

¹ On selected models only.



See [Internet and Network Connections](#) for more information about Bluetooth and wireless technology.

Using Special Buttons

Your VAIO® computer is equipped with a variety of audio- and video-oriented function buttons: Volume, Brightness, and Magnify screen.

About the special buttons

The following information shows where the special buttons are located, and briefly describes their functionality.

Special Buttons

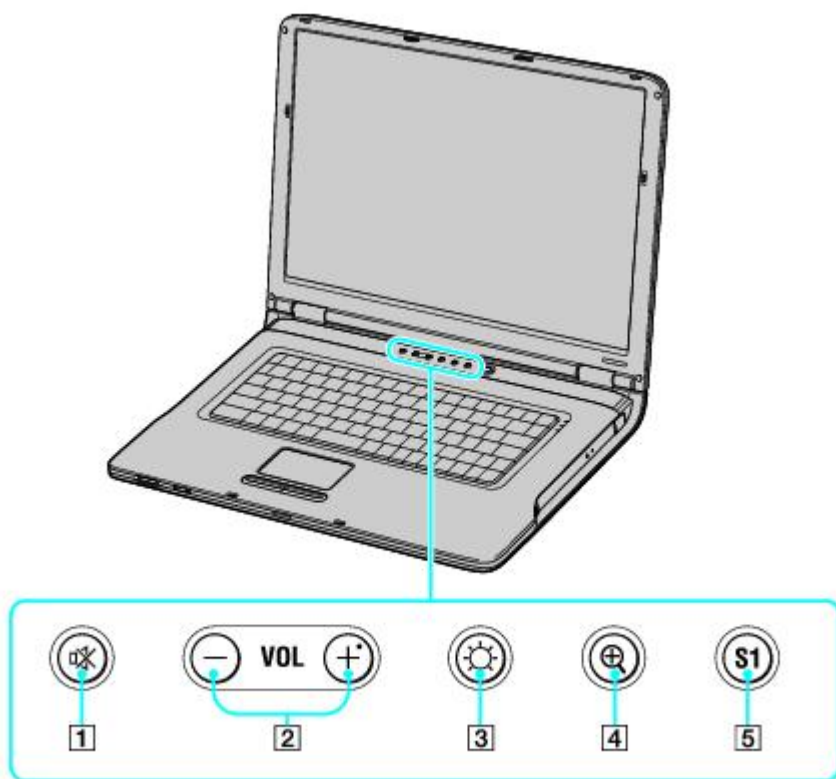

Number Type of Button

1 Mute. The Mute button enables and disables the audio output when using headphones or the internal speakers. This button does not enable and disable the audio output for Optical Out, Line Out, or AV Out connections. The Mute button illuminates when the audio output is disabled.

2 Volume. The Volume buttons control the audio output on your computer.

3 Brightness. The Brightness button, located between the Magnify screen and Volume buttons, toggles brightness levels for the computer's LCD screen. There are three brightness settings: Auto, Brightness, and Max. The brightness button illuminates when the brightness level is set to Brightness or Max.

4 Magnify screen. The Magnify screen button, located next to the computer's brightness button, works as a screen resolution toggle button. By pressing it, you can alternate between different screen resolutions.

5 S1. The S1 button is a pre-programmable button that enables you to enter a power saving mode, switch between displays, or launch an application.

Using the S1 button

As a shortcut, you can assign a pre-programmable S1 button to enter a power saving mode, switch between displays, or launch an application.

To assign a function to a programmable button

1. Click **Start**, and point to **All Programs** and then **Sony Notebook Setup**.
2. From the **Sony Notebook Setup** submenu, click **Sony Notebook Setup**.

 You can also click the S1 button on the computer to launch Sony Notebook Setup.

3. Click the **S1 Button** tab.

Sony Notebook Setup

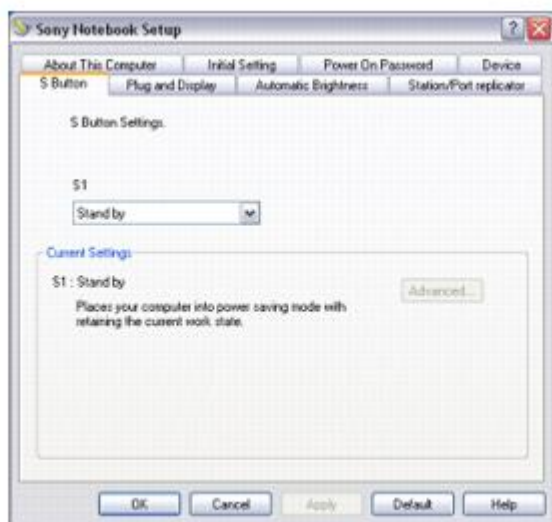

4. Click to select a key assignment from the **S1** drop-down menu.
5. Click **Apply**.
6. Depending on the key assignment, you may be able to customize the S1 button further by clicking **Advanced**, if it becomes available, in the **Current Settings** box.

Additional information about adjusting the brightness of the LCD screen

Your computer comes with a brightness sensor that automatically increases and decreases the LCD screen's brightness level depending on the amount of external light. The automatic sensor is engaged the first time you turn on your computer. To override the automatic setting and manually adjust the brightness, follow these steps:

- Press the Brightness button, located next to the Volume buttons, and select one of the three brightness settings (Auto, Brightness, or Max).
- Press the **Fn** and **F6** keys to increase brightness.
- Press the **Fn** and **F5** keys to decrease brightness.

Using the Keyboard

Although your computer's keyboard is very similar to a typewriter's keyboard, you can use the additional keys on the computer's keyboard to perform specific computer-related tasks.

Using the Keyboard

Although your computer's keyboard is very similar to a typewriter's keyboard, you can use the additional keys on the computer's keyboard to perform specific computer-related tasks.

Keyboard descriptions

Key	Description
-----	-------------

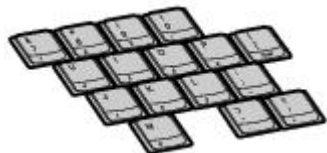

The numeric keypad contains the keys found on a typical calculator. Use the numeric keypad to type numbers or perform mathematical calculations, such as addition and subtraction. Numbers appear on the front beveled edge of the numeric keys. Press the Num Lock key to activate the numeric keypad. (When you do so, the Num Lock indicator light turns on.) Press the Num Lock key again to deactivate the numeric keypad.



The arrow keys move the pointer on the screen. They also function as the Home, End, Page Up, and Page Down keys, respectively, when the Fn key is pressed.



The correction keys enable you to make corrections to keystrokes.



The 12 function keys along the top of the keyboard perform designated tasks. For example, in many programs, F1 is the Help key. The task associated with each function key may vary from one program to the next.



The Escape key cancels commands.



The Print Screen key takes an electronic snapshot of the screen and moves it to the Clipboard. You can then paste the screen shot into a document and print it.



The operator keys provide a variety of commands. For example, in many programs, instead of choosing the Save command from a menu, you can hold down **Ctrl** and press **S** (referred to as **Ctrl+S**). Also, the Shift key to produces capital letters or special symbols, such as @ and \$.



The Windows key opens the Start menu. It is the equivalent of clicking Start on the Windows® taskbar. See [Windows key combinations](#) for more information.



The Fn key is used in combination with other keys to issue commands. See [Fn key combinations](#) for more information.



The Applications key opens a shortcut menu of context-sensitive choices. It is the equivalent of clicking the right mouse button.

Windows key combinations

Key combination	Function
-----------------	----------

 +F1	Displays the VAIO Help and Support Center window.
-------------------------------------------------------------------------------------	---------------------------------------------------

 +Tab	Switches the selected button on the taskbar.
--------------------------------------------------------------------------------------	----------------------------------------------

 +D	Displays the desktop.
------------------------------------------------------------------------------------	-----------------------

 +E	Displays the My Computer window.
------------------------------------------------------------------------------------	----------------------------------

 +F	Displays the Search Results window, where you can find a file or folder. This is the equivalent of selecting Search from the Start menu.
------------------------------------------------------------------------------------	------------------------------------------------------------------------------------------------------------------------------------------

 +Ctrl+F	Displays the Search Results - Computers window, where you can locate other computers. This is the equivalent of selecting Search, and then Computer from the Start menu.
-----------------------------------------------------------------------------------------	--------------------------------------------------------------------------------------------------------------------------------------------------------------------------

 +M	Minimizes all displayed windows.
------------------------------------------------------------------------------------	----------------------------------

Shift+  +M	Returns all minimized windows to their previous size.
----------------------------------------------------------------------------------------------	-------------------------------------------------------

 +R	Displays the Run window. This is the equivalent of selecting Run from the Start menu.
--------------------------------------------------------------------------------------	---------------------------------------------------------------------------------------

Fn+  +Insert	Displays the System Properties window. This is the equivalent of selecting Control Panel, and then System from the Start menu.
-----------------------------------------------------------------------------------------------	--------------------------------------------------------------------------------------------------------------------------------

Fn key combinations

Key combination	Function
-----------------	----------

Fn+F5	Decreases the LCD screen brightness.
-------	--------------------------------------

Fn+F6	Increases the LCD screen brightness.
-------	--------------------------------------

Fn+F7 Toggles the display between the computer screen (LCD), a connected external display, and both the LCD and an external display. Select one display when playing a DVD.

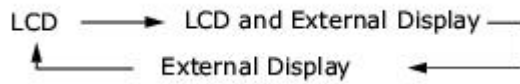

Fn+F12	Puts the system into Hibernate mode, a power management state. To return the system to normal operating mode, press the power button. Hibernate mode consumes the lowest level of power.
--------	------------------------------------------------------------------------------------------------------------------------------------------------------------------------------------------

Fn+Esc	Puts the system into Standby mode, a power management state. To return the system to the active state, press any key or the power button.
--------	-------------------------------------------------------------------------------------------------------------------------------------------

Connecting a Mouse or Keyboard

Your computer is compatible with many popular mice and keyboards. To function properly, the device you connect must be compatible with the Microsoft® Windows® operating system installed on your computer.

Connecting a mouse or keyboard

If you connect the mouse or keyboard when the computer is on, you may need to restart the computer for it to recognize the device.

To connect a USB mouse or keyboard to your computer

1. Plug the USB cable into the USB port . See [Locating Controls and Ports](#).

 One USB port supports one USB connection.

Connecting a USB Mouse or Keyboard

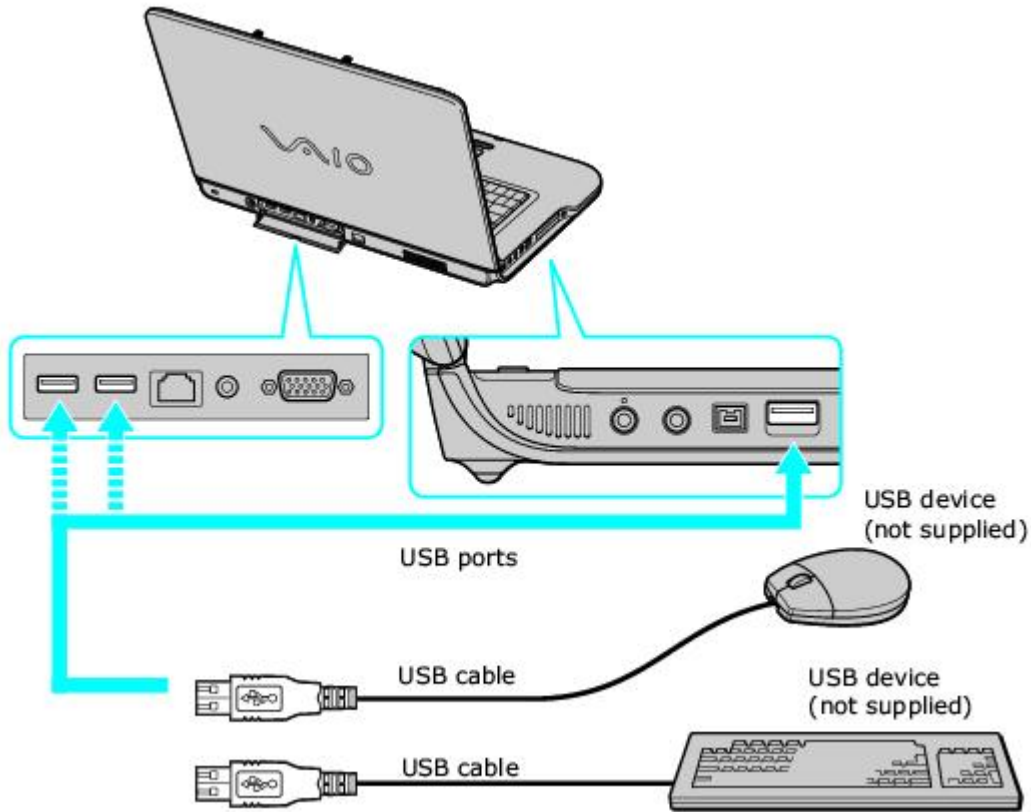

2. If the **New Hardware Wizard** appears, follow the on-screen instructions to complete the installation process.

 Although the New Hardware Wizard guides you through the software installation, some devices require separate driver software installation. See the instructions that accompanied your mouse or keyboard for more information

Disconnecting a mouse or keyboard

You can disconnect a USB mouse or keyboard when the computer is on or off. However, disconnecting the mouse or keyboard when the computer is in a power saving mode (Standby or Hibernate) may cause the computer to malfunction.

To disconnect a mouse or keyboard

- Unplug the USB cable from the USB port.

Connecting a Wireless Mouse

A wireless mouse is optional with your VAIO® computer. The following section explains the parts of the wireless mouse and how it works.

Wireless mouse (top)

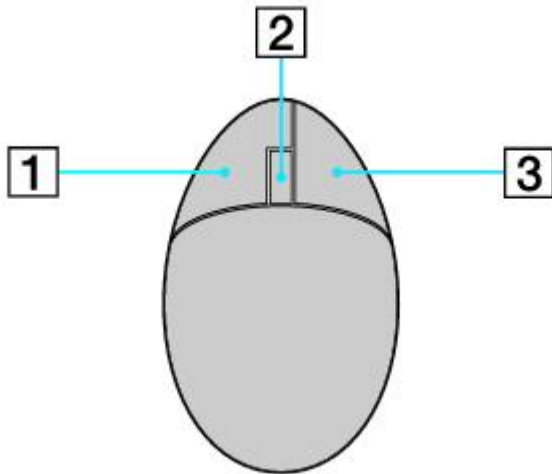

1 Left mouse button

Press to perform specific mouse functions.

2 Wheel button

Rotate the wheel to scroll up or down on the LCD screen.

3 Right mouse button

Press to perform specific mouse functions.

Wireless mouse (bottom)

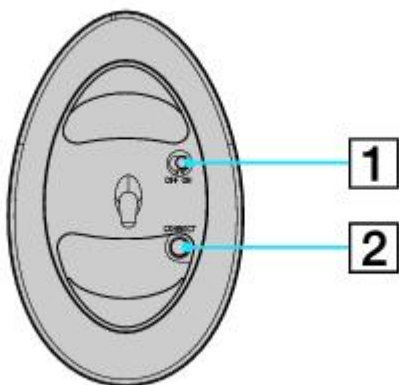

1 Power switch

Slide power switch to turn the mouse on or off.

2 CONNECT button

Press to enable communication between your VAIO® computer and the wireless mouse.

To set up the wireless mouse

Insert two AA batteries (supplied with the mouse) into the wireless mouse as shown.

Inserting batteries into the wireless mouse

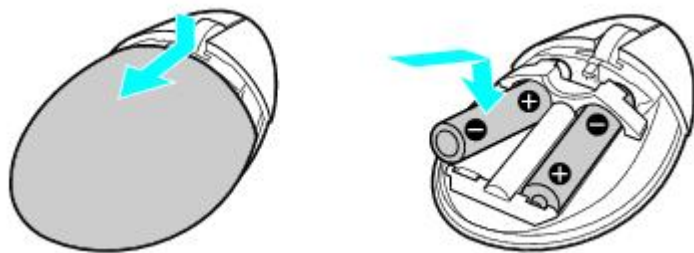

 If your wireless mouse does not operate properly, the batteries may need to be replaced. When your wireless mouse is not being used for extended periods of time, remove the batteries to avoid possible damage from battery leakage.

To connect the wireless optical mouse

Before attempting to use the wireless mouse, you must enable communication between the computer and the mouse.

 When attempting to connect the wireless mouse, confirm that the AA batteries (supplied) are properly inserted into the mouse before your computer is turned on.

1. Turn the wireless mouse over.
2. Slide the power button on the wireless mouse to the **ON** position.

Connecting the mouse

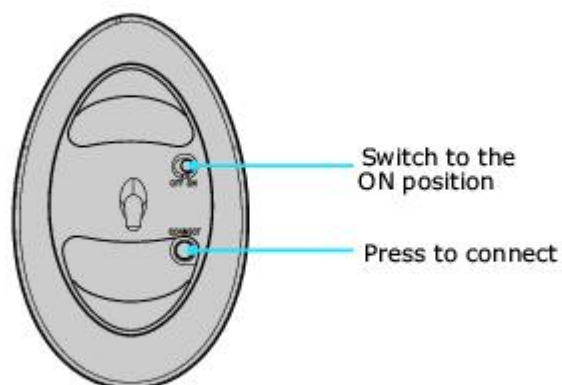

3. Turn on your computer.
4. Reach underneath the right side of the computer and press the **CONNECT** button.
5. Immediately, press the **CONNECT** button on the wireless mouse.

 Make sure to press the **CONNECT** button on the wireless mouse within 30 seconds after pressing the **CONNECT** button on the computer. The wireless mouse must be within 12 inches of the computer.

Positioning the mouse

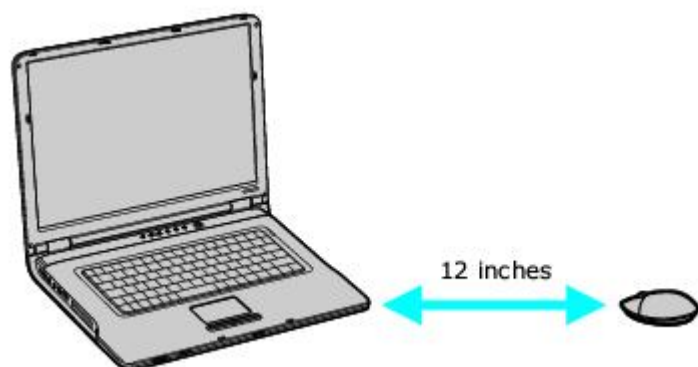

6. Place the optical mouse on an appropriate surface to enable tracking.

Additional information about the wireless optical mouse

The wireless optical mouse requires an ideal surface texture in order to provide precision pointing and tracking.

- Use surfaces such as plain paper, card stock, or fabric that have minimal repetitive patterns.
- Avoid surfaces such as mirrors, smooth glass, or magazines that have half- tone printing.

The wireless optical mouse requires unobstructed communication with the system unit for proper operation.

- Do not exceed a maximum distance of 2 feet between your VAIO® computer and your wireless mouse.
- Confirm that the supplied AA batteries are properly installed.
- Press the **Connect** buttons located underneath the right side of the computer and on the bottom of the mouse, to establish the communication between the equipment.
- Verify the infrared receiver on the computer's front panel is free of obstructions that may prevent proper operation.
- Avoid using radio-controlled toys or equipment, CB radios, and other wireless devices in the area near your wireless mouse. These devices may cause interference, causing your mouse to stop working properly.
- Do not place metal furniture near your computer or wireless mouse, as this may create interference, causing your mouse to stop working properly.

Describing the Touch Pad

A pointing device called a touch pad is located in front of the keyboard. You can point to, select, drag, and scroll objects on the screen using the built-in touch pad.

Describing the Touch Pad

A pointing device called a touch pad is located in front of the keyboard. You can point to, select, drag, and scroll objects on the screen using the built-in touch pad.

Locating and using the touch pad

Locating the Touch Pad

This illustration portrays a prototypical computer.

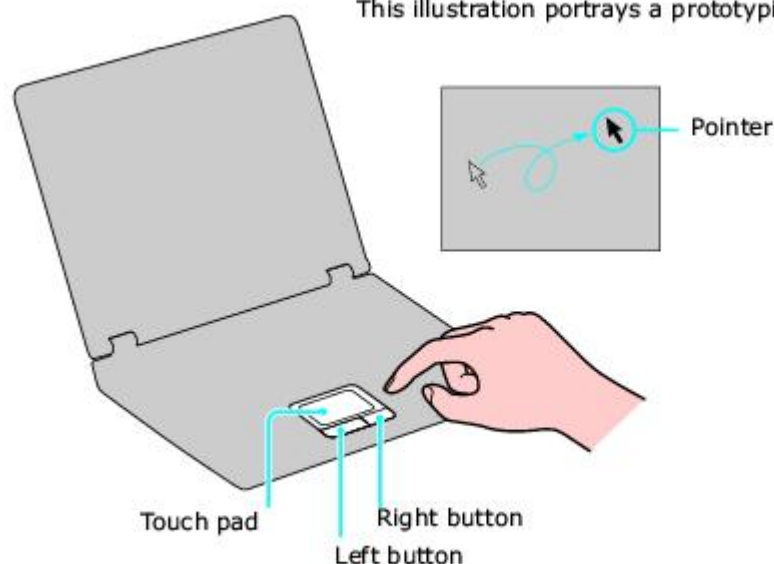

Touch Pad Action

Description

Sliding one finger

Equivalent to using a mouse to place the pointer on an item.

Tapping once

Equivalent to pressing the left button once.

Tapping twice

Equivalent to pressing the left button twice.

Sliding one finger while pressing the left button

Equivalent to using the mouse to drag an item.

Moving your finger along the right edge of the touch pad only with programs that support a touch pad scroll feature.)

Equivalent to scrolling vertically. (The scroll function is available

Moving your finger along the bottom to scroll horizontally available only with programs that support a touch pad scroll feature.)

Equivalent to scrolling horizontally. (The scroll function is



Customizing the touch pad

Sony Notebook Setup lets you customize, enable, or disable the touch pad. Open the Mouse Properties dialog box to set your touch pad and mouse preferences, such as changing pointers, enabling or disabling the tapping feature, clicking both buttons simultaneously, and adjusting the touch pad speed.

To customize the touch pad and mouse

- Right-click the **Touchpad** icon  on the **Taskbar Notification** area, and click **Mouse Properties** from the shortcut menu. The **Mouse Properties** dialog box appears.

To enable the touch pad

1. Press the **Windows** key . The **Start** menu appears.
2. Press **P** until **All Programs** is selected, and press **Enter**.
3. Press **S** until **Sony Notebook Setup** is selected, and press **Enter**. A submenu appears with **Sony Notebook Setup** preselected.
4. Press **Enter**. The **Sony Notebook Setup** dialog box appears.
5. Press the **Right Arrow** key  to select the **Device** tab.
6. Press the **Tab** key to select the **Default** button, and press **Enter**. A pop-up window appears.
7. Press the **Left Arrow** key  to select **OK**, and press **Enter**. The **Enable Touchpad** option is automatically selected.
8. Press the **Tab** key to select the **Apply** button, and press **Enter**.
9. Click **OK**.

To disable the touch pad

1. Click **Start** on the Windows® taskbar, and point to **All Programs**.
2. Point to **Sony Notebook Setup**, and click **Sony Notebook Setup** in the submenu. The **Sony Notebook Setup** dialog box appears.
3. Click the **Device** tab.
4. In the left panel, click to cancel the **Pointing Device** check box.
5. Click **Apply**. A Sony Notebook Setup message appears.
6. Click **Yes**.

Using the Multilingual User Interface Language Option

(Microsoft® Windows® XP Professional only) After you have initially setup your new VAIO® computer, you can change the language displayed in Microsoft® Windows® XP Professional operating system. The multilingual user interface (MUI) language option changes the text controlled by Windows XP Professional operating system. Menus, help files, and icons generated by Windows XP Professional are shown in your selected language. All other programs are displayed in English as the default language.

 The multilingual user interface language option is not designed to replace a localized version of the Microsoft® Windows® XP Professional operating system. Under certain conditions, some third-party software applications may not function properly.

To Change the Language Option

1. Click **Start** on the Windows® taskbar, and then click **Control Panel**.
2. Click **Date, Time, Language and Regional Options**, and then click **Regional and Language Options**. The **Regional and Language Options** dialog box appears.
3. Click the **Languages** tab.
4. From the **Language used in menus and dialogs** shortcut menu, select the desired language:
 - English
 - Español
 - Português
 - Français
5. Click **Apply**. The **Change Regional Options** shortcut window appears.
6. Click **OK**.
7. Click **Start** on the Windows® taskbar, and then click **Logoff**.

 Additional users can also change to their desired language(s) without affecting your existing language settings.

Changing Numbers, Currency, Time, and Date Formats

You can change your operating system's number, currency, time, and date formats to coordinate with your chosen country or language settings.

To change these formats

1. Click **Start** on the Windows taskbar, and then click **Control Panel**.
2. Click **Date, Time, Language and Regional Options**, and click **Regional and Language Options**. The **Regional and Language Options** dialog box appears.
3. From the **Regional Options** tab, click the **Standards and formats** shortcut menu to view the available country choices. Select the desired country.
4. Click **Customize** to change the number, currency, time, and date settings.
5. Click **Apply**.
6. Click **OK**.
7. Click **OK**.

Your VAIO® computer comes with a battery and an AC adapter. This chapter explains how to install and use these supplied accessories to power your computer. It also describes ways you can efficiently utilize the battery as a power source.

Using AC Power

The supplied battery is not charged when you receive your computer. To charge the battery and begin using the computer immediately, insert the battery into the computer and use the supplied AC adapter as a power source. The computer automatically charges the installed battery while it uses AC power.

Connecting the AC adapter

To connect the AC adapter

1. Plug the AC adapter cable into the DC IN port.

Connecting the AC Adapter to the Computer

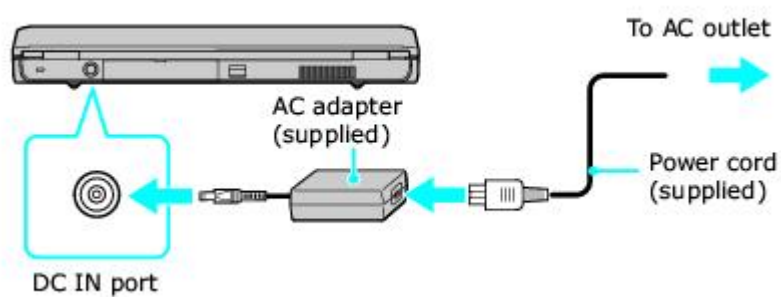

2. Plug the power cord into the AC adapter and an AC outlet.

 Use only the supplied AC adapter with your computer.

Turning on the computer

To open and turn on the computer

1. Press the release button and lift the cover while holding the bottom of the computer firmly.

Opening the Computer

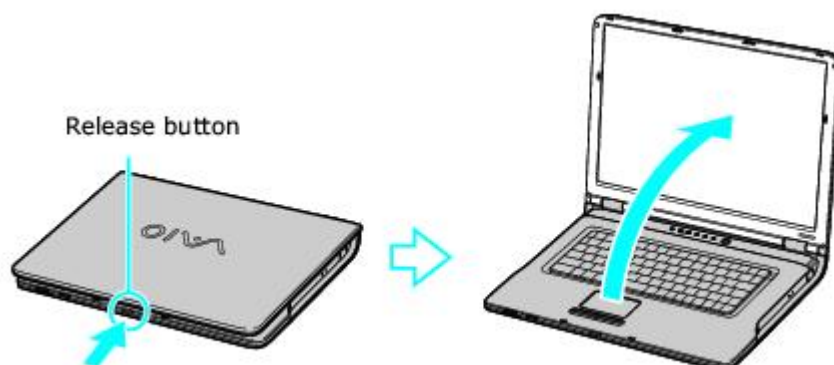

2. Press the power button until the green power indicator turns on.

Turning on the Computer

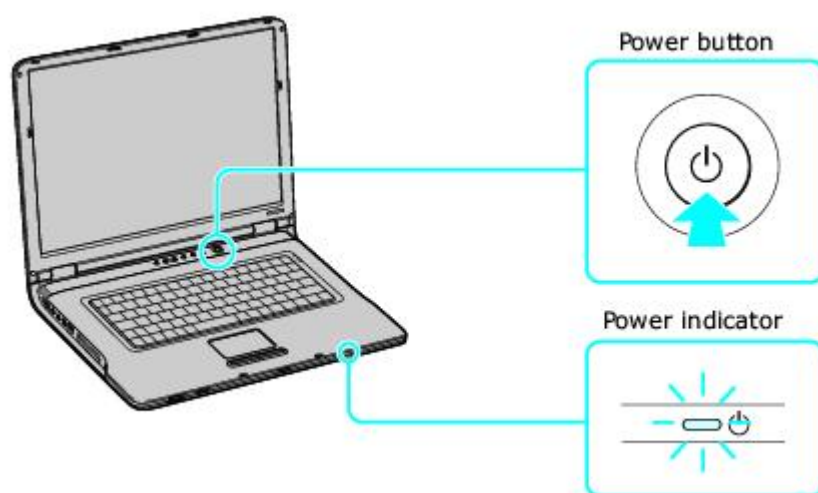

 If you continue to press the power button, the computer turns off.

3. If necessary, adjust the brightness of the LCD screen.

Your computer comes with a brightness sensor that automatically increases and decreases the LCD screen's brightness level depending on the amount of external light. To override the automatic setting and manually adjust the brightness, follow these steps:

- Press the Brightness button, located next to the Volume buttons. See [Using Special Buttons](#) for more information.
- Press the **Fn** and **F6** keys to increase brightness.
- Press the **Fn** and **F5** keys to decrease brightness.

Using the Battery

Your computer, depending on the model you purchased, may come equipped with one battery bay and one multipurpose bay that supports a second battery. If your computer comes with two bays, you can purchase a second rechargeable battery to extend your computing time. For information on how to extend the life of the battery, see [Conserving Battery Power](#) for more information.

 When operating your computer on battery power, your computer's CPU speed is reduced.

 The battery that comes with your computer is not fully charged at the time of purchase.

 Only genuine Sony batteries may be used.

Using the Battery

The supplied battery is not charged when you unpack it. To charge it for future use, install the battery, and then connect the AC adapter to power your computer. The battery charges from AC power regardless if the computer is on or off. For information on how to extend the life of the battery, see [Conserving Battery Power](#).

Inserting a battery

To insert a battery

1. First turn the computer over so the bottom panel is facing up.
2. Slide the **LOCK/UNLOCK** switch to **UNLOCK**, and then slide the **RELEASE** switch in the direction of the arrow to lift the battery bay cover.

Opening the Battery Bay

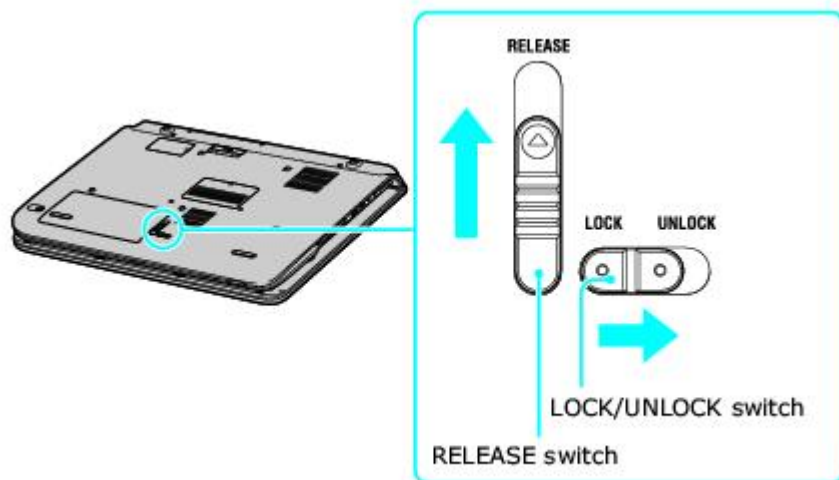

3. Slide the battery (with the logo facing up) into the battery bay cover. The two hooks on each side of the battery bay cover should click into the grooves on the battery.

Inserting a Battery

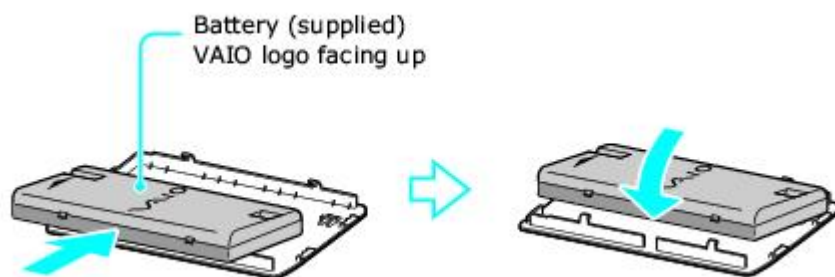

4. With the battery securely inserted into the battery bay cover, align the hooks on the battery bay cover with the grooves inside the battery bay.
5. Lower the battery into the battery bay until you hear it click.

Securing the Battery

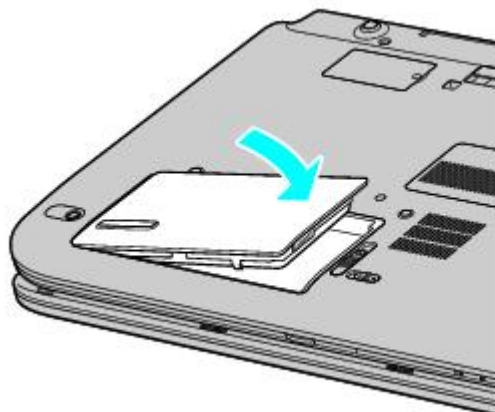

6. Slide the **LOCK/UNLOCK** switch to **LOCK**.

Some programs and peripheral devices prevent the system from automatically entering Hibernate. If you are using battery power, save your data frequently to avoid data loss and manually activate a power saving mode. See [Using power saving modes](#) for more information.

Removing a battery

If you are not using the computer for an extended period of time, remove the battery from the computer to avoid damaging the battery.

⚠ If the computer is on, connect the AC adapter and exit a power saving mode before you remove the battery.

To remove a battery

1. Make sure the computer is turned off.
2. Turn the computer over so the bottom panel is facing up.
3. Slide the **LOCK/UNLOCK** switch to **UNLOCK**, and then slide the **RELEASE** switch in the direction of the arrow to lift the battery bay cover.

Removing the Battery

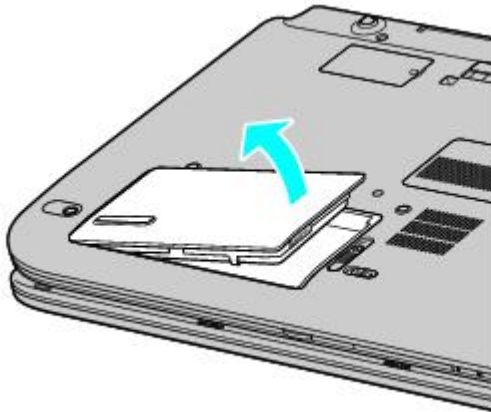

4. Holding the battery bay cover steady, gently pry the tabs located on either side of the battery bay cover from the grooves in the battery, and lift the battery from the battery bay cover.

Locating battery information

Displaying the battery status provides useful information, such as remaining battery life.

To view battery information

1. Click **Start** on the Windows® taskbar, and click **Control Panel**.
2. Click **Performance and Maintenance**, and click **Power Options**. The **Power Options Properties** window appears.
3. Select the **Power Meter** tab. The total remaining battery charge is listed as a percentage.

 You may also use the power icon on the Windows® taskbar to quickly view battery information. See [To display the power icon on the taskbar](#) for instructions on how to set up this shortcut.

To display the power icon on the taskbar

1. Click **Start** on the Windows® taskbar, and click **Control Panel**.
2. Click **Performance and Maintenance**, and click **Power Options**. The **Power Options Properties** window appears.
3. Select the **Advanced** tab, and then select **Always show icon on the taskbar** in the **Options** box. The power icon appears on the taskbar. See the power icon descriptions below for more information.

You can rollover the power icon to view the remaining battery charge, and you can double-click the power icon to open the Power Meter window, which also displays the remaining battery charge.

Power icon Power status



Computer is using AC power.



Computer is using AC power and charging the battery.



Battery is charging.



Battery is fully charged.



Battery is discharging.



No battery is inserted in the computer.

Charging a battery

You will need to charge the battery if battery power drops below 10 percent or you have not used the battery for a long time. The lithium-ion battery supplied with your computer may be recharged at any time, whether you wait until the battery is completely or partially discharged. Charging a partially discharged battery does not affect battery life. If you charge the battery and find that battery power is still low, the battery may be reaching the end of its life, and you may need to replace it.

 The battery supplied with your computer is not charged at the time of purchase.

To charge a battery

You can charge the battery when the computer is on or off. However, the battery will charge faster when the computer is off. Charging the battery takes several hours.

 Charge the battery at temperatures between 50°F and 80°F (10°C to 30°C). Lower temperatures require more time to charge.

1. Insert the battery into the battery bay.
2. Connect the AC adapter to the computer. The computer automatically charges the battery as long as the computer is using AC power.

The battery indicator blinks while the battery charges. The battery indicator stops blinking when the battery is fully charged.

 When using two batteries, the battery you insert first charges first. The second battery you insert begins charging when the first battery is 85 percent charged.

Battery indicator status Description

On	The computer is using battery power.
Single blink	The battery is running out of power.
Double blink	The battery is charging.
Off	The computer is using AC power.

Notes on batteries

- Never leave the battery in temperatures above 140°F (60°C), such as under direct sunlight or in a car parked in the sun.
- While the battery is in use or being discharged, the battery heats up. This is normal and is not cause for concern.
- Keep the battery away from heat sources.
- Keep the battery dry.
- Do not open or disassemble the battery.
- Do not expose the battery to any mechanical shock.
- Battery life is shorter in a cold environment because of decreased battery efficiency at low temperatures.
- Only genuine Sony batteries may be used.

Conserving Battery Power

You may use the power saving modes and power schemes to conserve battery power. Conserving battery power may significantly extend your computing time, depending on how you use your computer.

Using power saving modes

In addition to the normal operating mode, which allows you to turn off specific devices to save power, your computer has two distinct power saving modes: Standby and Hibernate. Use the Standby and Hibernate power saving modes to override a power profile setting and initiate immediate action.

- **Standby** — Saves the state of the system and peripheral devices in memory (RAM). Power consumption is reduced to a minimum. The system remains on, and the computer screen (LCD) is off.
- **Hibernate** — Saves the state of the system and peripheral devices to the hard disk. Power consumption is reduced to the lowest possible setting without being completely off. Hibernate mode consumes the lowest level of power. Your computer enters Hibernate mode when the remaining battery charge drops below 5 percent, regardless of the setting you select.

 Since some programs and peripheral devices prevent the system from entering Hibernate mode, save your data frequently to avoid data loss.

To activate Standby mode

1. Press the **Fn** and **Esc** keys. The power indicator blinks in this mode.
2. Press any key to return to normal mode.

To activate Hibernate mode

1. Press the **Fn** and **F12** keys, or press the power button and release it immediately. Do not move the computer until the power indicator turns off.
2. Press the power button to return to normal mode.

 If your computer does not activate Hibernate mode, see [Why doesn't my computer enter Hibernate mode?](#) for more information.

Using power schemes

You can use the preset power schemes or you can customize the power profiles to conserve power. By using the power schemes and power profiles, you control the power supplied to different devices, such as the computer screen (LCD) and the hard disk drive, in your computer. You also control when the computer activates a power saving mode (Standby or Hibernate).

To select a power scheme

1. Click **Start** on the Windows® taskbar, and click **Control Panel**.
2. Click **Performance and Maintenance**, and click **Power Options**. The **Power Options Properties** window appears with the **Power Schemes** tab selected.
3. Select a power scheme from the drop-down menu in the **Power schemes** box. Each power scheme is preset to utilize your power supply efficiently, according to your computing functions. Select the power scheme that best explains how you want to use your computer.
4. Click **Apply**.

To create a power scheme

1. Click **Start** on the Windows® taskbar, and click **Control Panel**.
2. Click **Performance and Maintenance**, and click **Power Options**. The **Power Options Properties** window appears with the **Power Schemes** tab selected.

 You can also right-click the Power icon on the Windows® taskbar, and select **Adjust Power Properties** to open the **Power Options Properties** window.

3. Select your changes from the drop-down menus in the **Settings for....power scheme** box, and click **Save As** in the **Power schemes** box. The **Save Scheme** window appears.
4. Type a name for your customized power scheme, and click **OK**. The power scheme you created appears in the **Power schemes** box.

 If you want to delete a power scheme, select the power scheme and click **Delete**. When the **Delete Scheme** window appears, click **Yes**.

To customize your power properties

1. Click **Start** on the Windows® taskbar, and click **Control Panel**.
2. Click **Performance and Maintenance**, and click **Power Options**. The **Power Options Properties** window appears.

 If you want to access the power scheme information quickly from the Windows® taskbar, see [To display the power icon on the taskbar](#) for more information.

3. Select the **Advanced** tab, and select your changes from the drop-down menus in the **Power buttons** box. See [Using power saving modes](#) for information on how Standby and Hibernate modes affect power consumption.
4. Click **Apply**.

To use VAIO Power Management

VAIO Power Management is a software program that enables you to further adjust the power settings on your computer. Once you have selected a power scheme under the **Power Schemes** tab, you can modify it in the VAIO Power Management tab to enhance your computer's operations.

1. Click **Start** on the Windows® taskbar, and click **Control Panel**.
2. Click **Performance and Maintenance**, and click **Power Options**. The **Power Options Properties** window appears.
3. Select the **VAIO Power Management** tab, and specify the options you want to adjust.

4. Click **Apply**.

To set your battery alarm

You can change your computer settings to notify you when the battery power reaches a certain level.

1. Click **Start** on the Windows® taskbar, and click **Control Panel**.
2. Click **Performance and Maintenance**, and click **Power Options**. The **Power Options Properties** window appears.
3. Select the **Alarms** tab, and then select the type of alarm you want the computer to activate: a low or a critical battery alarm.
4. Drag the slider to the battery level at which you want the computer to activate the alarm. By default, the **Low battery alarm** is set to 10 percent, and the **Critical battery alarm** is set to 5 percent.
5. Click **OK**.

 To further customize your alarm settings, click **Alarm Action**. In this window, you can select the type of alarm you want the computer to activate and how you want the computer to respond to the alarm.

Locating battery information

Displaying the battery status provides useful information, such as remaining battery life.

To view the Power Meter window

1. Double-click the **Power** icon. The **Power Meter** window appears. You can also rollover the Power icon to view the remaining battery charge.

Power icon Power status



Computer is using AC power.



Computer is using AC power and charging the battery.



Battery is charging.



Battery is fully charged.



Battery is discharging.



No battery is inserted in the computer.

If the Power icon is not displayed on the Taskbar Notification area, see [To display the Power icon on the taskbar.](#)

Power Meter*

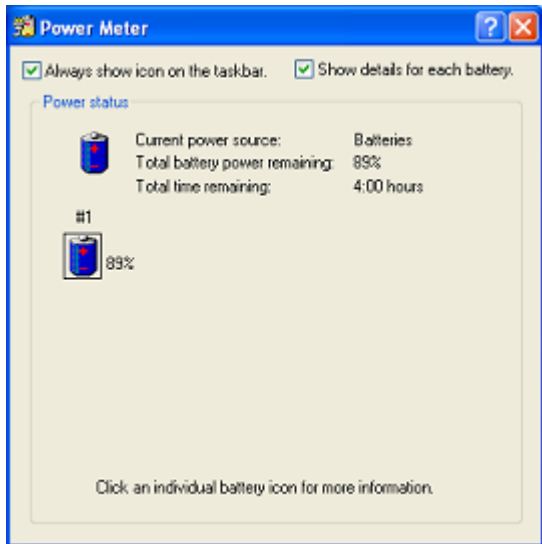

* The Power Meter window may appear slightly different on your computer, depending on the number of batteries your computer supports.

To display the Power icon on the taskbar

1. Click **Start** on the Windows® taskbar, and click **Control Panel**.
2. Click **Performance and Maintenance**, and click **Power Options**. The **Power Options Properties** window appears.
3. Select the **Advanced** tab, and then select **Always show icon on the taskbar** in the **Options** box. The power icon appears on the taskbar. See the power icon descriptions above for more information.

Internet Connections

This section describes the basic steps for setting up your dial-up or Ethernet connection to the Internet. The New Connection Wizard guides you through the process of connecting to the Internet and choosing an Internet service provider (ISP) or setting up an existing account. When you connect to the Internet, you can register your VAIO® computer, use online services, and gain access to Sony Computing Support.

Internet Connections

This section describes the basic steps for setting up your dial-up or Ethernet connection to the Internet. The New Connection Wizard guides you through the process of connecting to the Internet and choosing an Internet service provider (ISP) or setting up an existing account. When you connect to the Internet, you can register your VAIO® computer, use online services, and gain access to Sony Computing Support.

Setting up a dial-up Internet connection

Before you can connect to the Internet, you need to connect your computer to a telephone line via a telephone cable (not supplied). Once you set up your telephone cable, you're ready to connect to the Internet.

To connect a telephone cable

1. Locate the Modem jack on your computer. For location information, see "Locating Controls and Ports."
2. Plug one end of the telephone cable into the Modem jack. Make sure it clicks into place.
3. Plug the other end into the wall jack.

Connecting a Telephone Cable

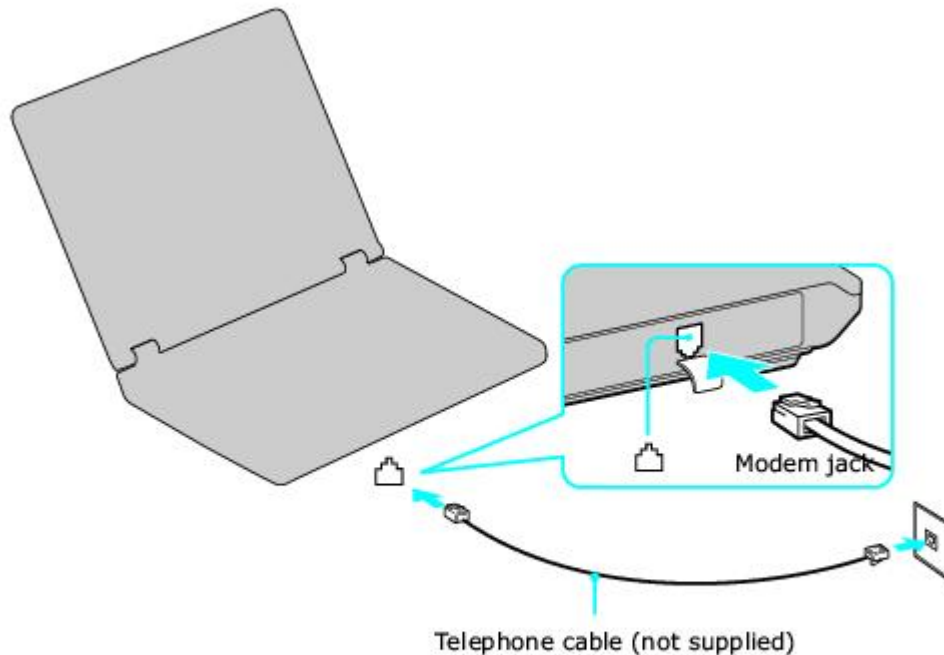

This illustration portrays a prototypical computer.
Actual port locations differ between computer models.

 Your computer does not work with party lines, cannot be connected to a coin-operated telephone, and may not work with multiple telephone lines or a private branch exchange (PBX). Some of these connections may result in excess electrical current and could cause a malfunction in the internal modem.

If you connect a telephone cable coming through a splitter, the modem or connected device may not work properly.

To set up a dial-up connection to the Internet

1. Connect your computer to a telephone line. See [To connect a telephone cable](#) for more information.
2. Click **Start**, point to **All Programs, Accessories, Communications**, and click **New Connection Wizard**. The **New Connection Wizard** appears.

New Connection Wizard



3. Click **Next**. If the **Location Information** dialog box appears, follow the on-screen instructions.
4. If it is not already selected, click to select **Connect to the Internet**, and click **Next**.
5. Follow the on-screen instructions.

Setting up an Ethernet Internet connection

Your computer accommodates both 10BASE-T and 100BASE-TX Ethernet connections, with data transfer speeds of between 10 and 100 Mbps.

To connect an Ethernet cable

1. Locate the Ethernet port on your computer. For location information, see "Locating Controls and Ports."

Connecting an Ethernet Cable

This illustration portrays a prototypical computer. Actual port locations differ between computer models.

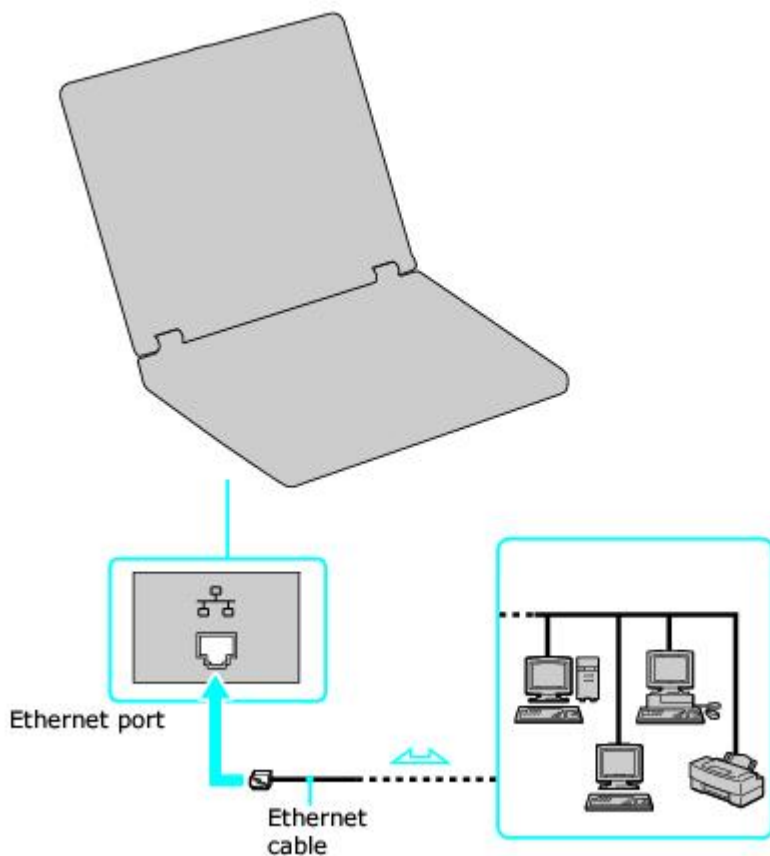

2. Plug one end of the Ethernet cable into your computer's Ethernet port  and the other into the network connection.

To set up an Ethernet connection to the Internet

1. Connect your computer to a network connection.
2. Click **Start**, point to **All Programs, Accessories, Communications**, and click **New Connection Wizard**. The **New Connection Wizard** appears.

New Connection Wizard



3. Click **Next**. If the **Location Information** dialog box appears, follow the on-screen instructions.
4. If it is not already selected, click to select **Connect to the Internet**, and click **Next**.
5. Follow the on-screen instructions.

Customizing your Internet connection

The Internet Properties dialog box enables you to change the way you view the Internet. You can change your home page, fonts, language, and colors. You can also regulate content and set browsing preferences.

To open the Internet Properties dialog box

1. Click **Start** on the Windows® taskbar, and then **Control Panel**.
2. Click **Network and Internet Connections**, and then **Internet Options**. The **Internet Properties** dialog box appears.
3. Click the tabs to view options.
4. Make changes, and click **Apply** to activate your changes.
5. Click **OK**.

Network Connections

With a Sony computer, you can easily set up or connect to a variety of networks. The New Connection Wizard and Network Setup Wizard make it easy to gain access to networks (LANs) using wireless, Ethernet, or dial-up connections.

For more information about networking, click **Start, Help and Support**, and then **Networking and the Web**.

Types of Networks*

Access point (wireless)



Computer-to-computer
(wireless)



Ethernet (cables)

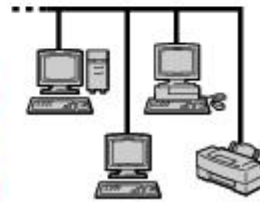

* The computers represented in this illustration are for representative purposes only and may not be identical to the model you purchased.

Using Ethernet and dial-up connections

For setting up local area networks (LANs), Ethernet is a widely installed technology. Your computer accommodates both 10BASE-T and 100BASE-TX Ethernet connections, with data transfer speeds of between 10 and 100 Mbps.

To connect to a local area network using a telephone or Ethernet cable

1. Connect an Ethernet or telephone cable to your computer. See [To connect an Ethernet cable](#) and [Setting up a dial-up Internet connection](#) for more information.

Connecting an Ethernet Cable

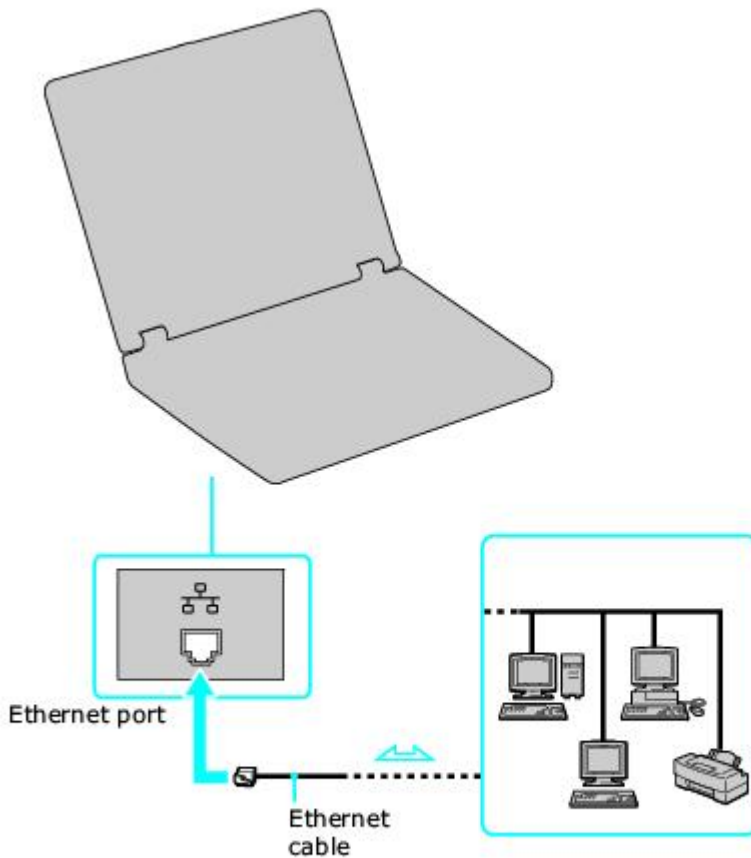

This illustration portrays a prototypical computer. Actual port locations differ between computer models.

2. Click **Start**, point to **All Programs, Accessories, Communications**, and click **Network Setup Wizard**. The **Network Setup Wizard** appears.

Network Setup Wizard

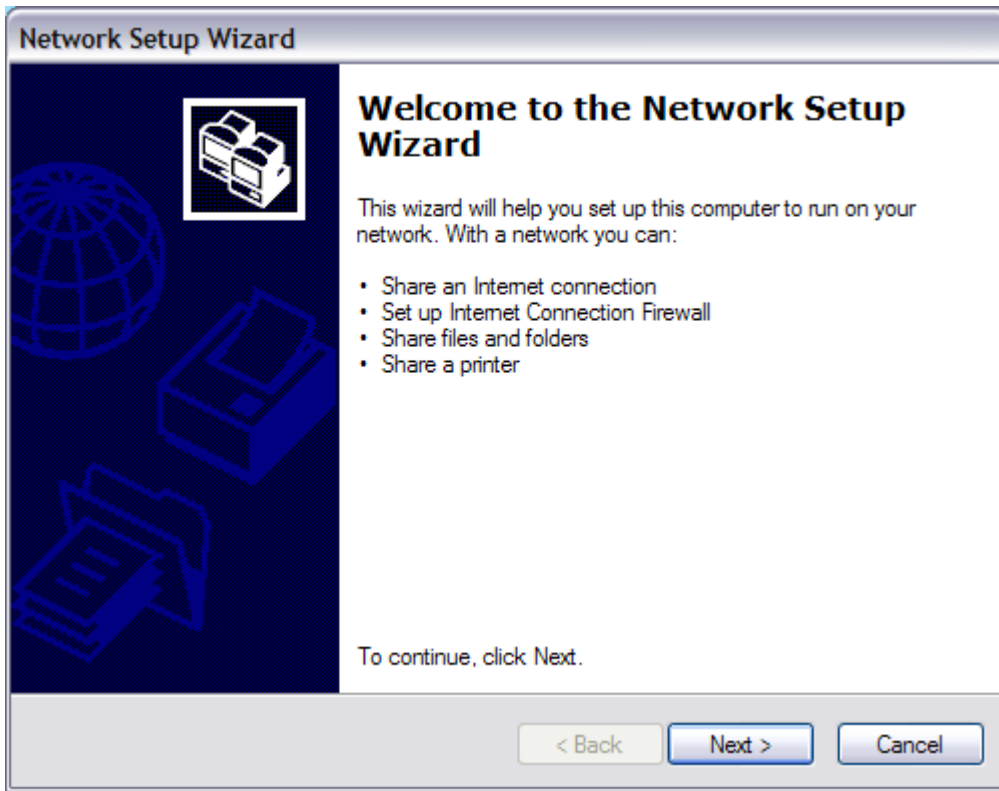

3. Click **Next**. If you are prompted to the **Local Information** dialog box, follow the on-screen instructions.



Only connect 10BASE-T and 100BASE-TX cables to the Ethernet port . Do not connect any other type of network cable or any telephone cable. Connecting cables other than those listed above may result in an electric current overload and could cause a malfunction, excessive heat, or fire in the port. To connect the unit to the network, see [Using Ethernet and dial-up connections](#) or contact your network administrator.

You can connect to an Ethernet network from a remote location and use data, programs, and network resources. See Microsoft® Windows® Help by clicking **Help and Support** from the **Start** menu, and then clicking **Networking and the Web** in the left panel.

To connect to a remote network using a telephone or Ethernet cable

1. Connect an Ethernet or telephone cable to your computer. See [To connect an Ethernet cable](#) and [Setting up a dial-up Internet connection](#) for more information.
2. From the **Start** menu, point to **All Programs, Accessories, Communications**, and click **New Connection Wizard**.
3. Click **Next**. If you are prompted to the **Local Information** dialog box, follow the on-screen instructions.
4. Click **Connect to the network at my workplace**, and then click **Next**.
5. Follow the on-screen instructions.
6. Ask your network administrator for the detailed settings and devices needed to connect to an existing network.

Using wireless network connections (selected models only)

A wireless local area network (LAN) is a network in which you can connect to a LAN through a wireless (radio) connection. You can opt to purchase a Sony Wireless LAN Access Point to set up a LAN.

The wireless LAN access point is designed for building a wireless LAN environment. Because a wireless LAN configuration requires no wiring, you can operate multiple computers more freely than ever before.

Your computer is equipped with a built-in mini PCI card that allows for wireless connections. For information about your computer's wireless capabilities, see the VAIO® Computer Specifications.

 For more information on Sony Wireless LAN, go to <http://www.sonymstyle.com/vaio>.

There are two types of wireless connections:

- An infrastructure network is one that extends an existing wired local network to wireless devices by providing an access point. The access point bridges the wireless and wired LAN and acts as a central controller for the wireless LAN. The access point coordinates transmission and reception from multiple wireless devices within a specific range. For more information, see [To connect to a wireless network](#).
- A computer-to-computer (ad-hoc) network is one in which a local network is created only by the wireless devices themselves, with no other central controller or access point. Each device communicates directly with other devices in the network. You can set up an ad-hoc network easily at home. For more information, see [To set up a computer-to-computer \(ad-hoc\) network](#).

To connect to a wireless network

1. Make sure an access point is set up. See the instructions that accompanied the access point for more information.
2. Move the Wireless LAN switch to **ON**. (For location information, see "Locating Controls and Ports.")

The **Switch wireless devices** window appears.

Switch Wireless Devices



3. Click to select the **Bluetooth** option, and then click **OK**.

During first use, the **Welcome to BlueSpace NE** window appears.

 To open the **Switch wireless devices** window, click the **Bluetooth-ON** icon  on the Taskbar Notification area.

4. Click **Start, Control Panel, Network and Internet Connections**, and then click **Network Connections**. The **Network Connections** window appears.
5. In the right panel under **LAN or High-Speed Internet**, click **Wireless Network Connection Enabled**. The Wireless Network Connection window appears.

Wireless Network Connection



6. From the **Available wireless networks** list, select the name of the network in which you want to connect. If you do not see the network name, see [If the network does not appear in the Available wireless networks list box.](#)
7. If required, type the network key in the **Network key** box. (If necessary, ask the administrator for the key.)
8. Retype the network key in the **Confirm network key** box.
9. Click **Connect**.

If the network does not appear in the Available wireless networks list box

1. Click **Advanced** on the **Wireless Network Connection** dialog box. The **Wireless Network Connection Properties** dialog box appears.

Wireless Network Connection Properties

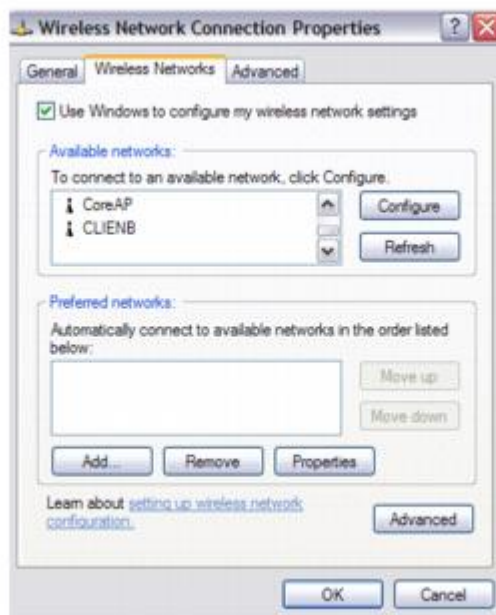

2. Click **Add** in the **Preferred networks** box. The **Wireless network properties** dialog box appears.

Wireless Network Properties

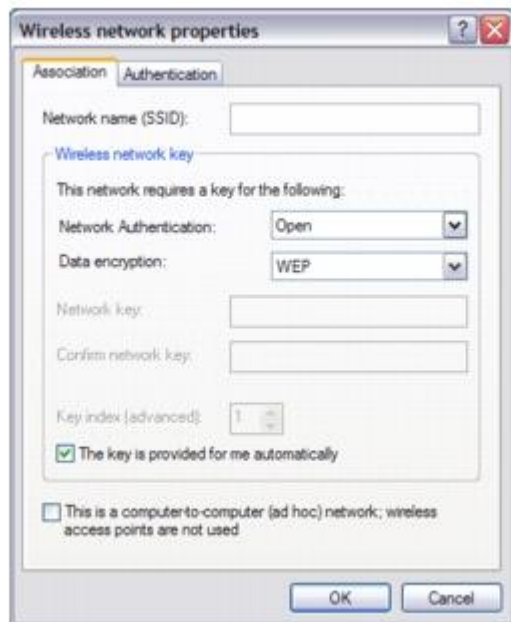

3. Type the name of the network (access point) you want to connect to in the **Network name (SSID)** box.

 The following steps are for networks that require a network key. If you do not know the network key or are not sure a network key is required, see the network administrator or the guide that accompanied your access point for more information.

4. If available, make sure the **Data encryption (WEP enabled)** check box is selected. If the **Data encryption (WEP enabled)** check box is not available:
 1. Select an authentication method from the **Network Authentication** menu.
 2. Select a data encryption method from the Data Encryption menu.
5. Click to cancel the **The key is provided for me automatically** check box.
6. Type the network key in the **Network key** box if it is required by the selected authentication method.
7. Retype the network key in the **Confirm network key** box.
8. Click **OK**. The network name appears in the **Preferred networks** list box.

To set up a computer-to-computer (ad-hoc) network

The computer-to-computer (ad-hoc) network is only supported by the IEEE 802.11b wireless standard.

1. Move the Wireless LAN switch to **ON**. For location information see "Locating Controls and Ports."
2. Click **Start, Control Panel, Network and Internet Connections**, and then click **Network Connections**. The **Network Connections** window appears.
3. In the right panel under **LAN or High-Speed Internet**, click **Wireless Network Connection Enabled**. The Wireless Network Connection window appears.

Wireless Network Connection



4. Click **Advanced**. The **Wireless Network Connection Properties** dialog box appears.

Wireless Network Connection Properties

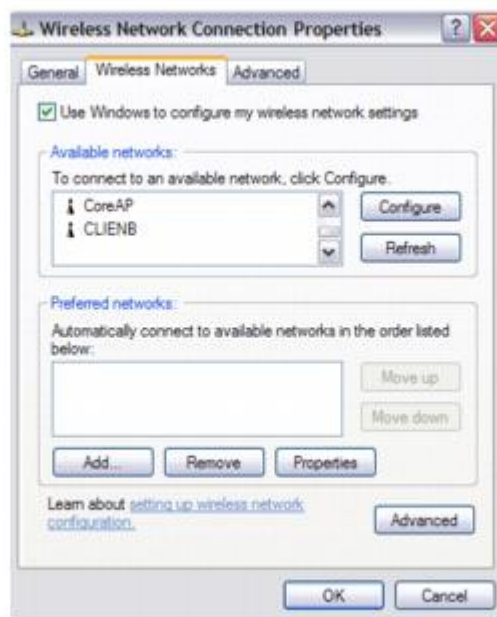

5. Click **Add**. The **Wireless network properties** dialog box appears.

Wireless Network Properties



6. Type the name of the network you want to connect to in the **Network name (SSID)** box.
7. If available, make sure the **Data encryption (WEP enabled)** check box is selected.
If the **Data encryption (WEP enabled)** check box is not available:
 1. Select an authentication method from the **Network Authentication** menu.
 2. Select a data encryption method from the **Data Encryption** menu.
8. Click to cancel the **The key is provided for me automatically** check box.
9. Type a network key in the **Network key** box.
10. Retype the network key in the **Confirm network key** box.
11. Click to select **This is a computer-to-computer (ad hoc) network; wireless access points are not used.**
12. Click **OK**. The network name appears in the **Preferred networks** list box.
13. Click **Advanced**. The **Advanced** dialog box appears.

Advanced



14. Click to select **Computer-to-computer {ad hoc} networks only**, and then click **Close**.

To disconnect from a wireless network

- For computers with built-in wireless LAN functionality, move the Wireless LAN switch to OFF.



Turning off the wireless LAN functionality while accessing remote documents, files, or resources may result in data loss.

To disconnect from a computer-to-computer (ad-hoc) network

1. Click **Start, Control Panel, Network and Internet Connections**, and then click **Network Connections**. The **Network Connections** window appears.
2. In the right panel under **LAN or High-Speed Internet**, click **Wireless Network Connection Enabled**. The **Wireless Network Connection Status** window appears.
3. Click **Properties**. The **Wireless Network Connection Properties** dialog box appears.
4. On the **Wireless Networks** tab, click **Advanced**. The **Advanced** dialog box appears.
5. Click to select **Any available network (access point preferred)**, and click **Close**.
6. Move the Wireless LAN switch to **OFF**.

Checking your network connection status

Whether you have a wireless, Ethernet, or dial-up connection, you can check the status of that connection.

To check your network connection status

1. Click **Start** on the taskbar, and click **Control Panel, Network and Internet Connections,** and **Network Connections.** The **Network Connections** window appears.
2. Under **LAN or High-Speed Internet,** click the enabled network connection to open the connection status window.

Wireless Network Connection Status

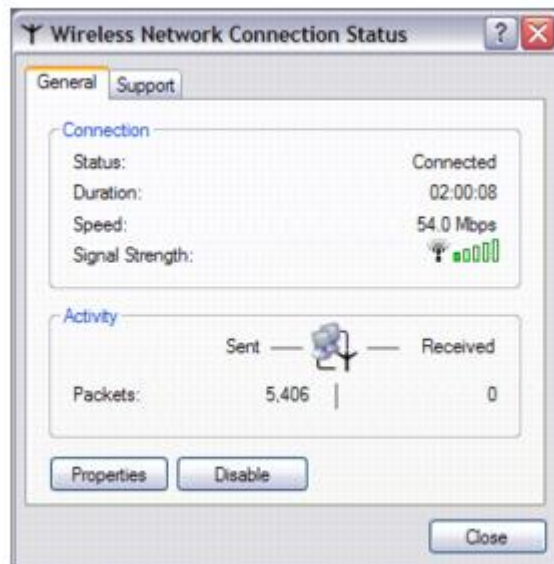

Bluetooth Connections

Bluetooth® wireless technology provides short-range connectivity without the need for cabling. When the Bluetooth functionality is turned on, your computer can exchange data and images with other compatible Bluetooth devices within a range of up to 32 feet.

 With Bluetooth technology, your computer transmits a radio frequency of 2.4 GHz. Sensitive locations, such as hospitals and airplanes, may have restrictions on the use of Bluetooth devices, due to radio interference. Check with facility staff to verify that use of the Bluetooth feature on your computer is permitted.

Using Bluetooth technology

Using Bluetooth® technology, your computer can communicate with:

- Compatible devices with integrated Bluetooth functionality, such as computers, mobile telephones, personal digital assistants (PDAs), mice, and keyboards.
- Compatible devices with an installed Bluetooth adapter, such as computers, printers, mice, and keyboards.

 Some Bluetooth devices may not work with your computer, depending on the type of equipment, software version, and other factors. Before purchasing a Bluetooth device, check its operating environment requirements.

A computer with Bluetooth features can:

- Send files and images between compatible devices
- Exchange vCards (electronic business cards)
- Connect to the Internet using a dial-up connection
- Print files and images on a printer equipped with Bluetooth technology
- Exchange addresses with compatible cellular phones

Establishing wireless connections

The "Switch wireless devices" window enables you to select a wireless connection: Bluetooth, Wireless LAN, or Bluetooth and Wireless LAN function.

Bluetooth® technology is designed for a short-range connection of up to 32 feet (10 meters), while Wireless LAN technology has a wider connection range of up to 328 feet (100 meters). Your computer is capable of both Bluetooth and Wireless LAN connections. For more information about Wireless LAN, see [Using wireless network connections \(selected models only\)](#).

To establish a Bluetooth connection

1. On your computer, move the WIRELESS switch to **ON**.

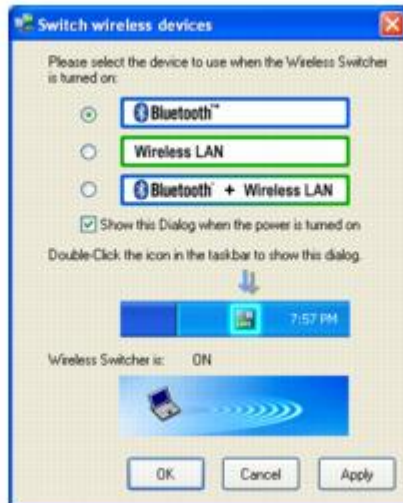

The **Switch wireless devices** window appears.

Switch Wireless Devices



2. Click to select the **Bluetooth** option, and then click **OK**.

During first use, the **Welcome to BlueSpace NE** window appears.

 To open the **Switch wireless devices** window, click the **Bluetooth-ON** icon  on the Taskbar Notification area.

Welcome to BlueSpace NE

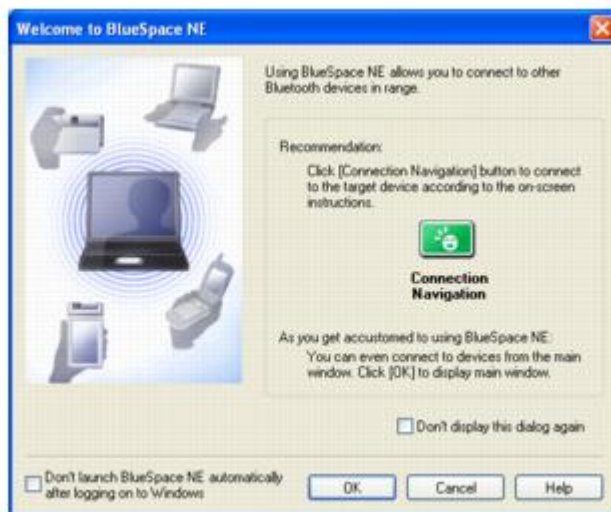

3. Click **OK**.

The **BlueSpace NE** window appears.

 You can also click the **Bluetooth-Standing by** icon  on the Taskbar Notification area to open the **BlueSpace NE** window.

Device Discovery



4. Click **Device Discovery**.

The **Device Discovery** window appears and searches for other nearby Bluetooth devices.

Device Discovery



When a device is detected, it appears in the **The device currently found** window next to the **New** icon *New*.

BlueSpace NE – Devices Currently Found



5. In **The device currently found** area, click to select the device in which you want to connect. (There may be more than one device displayed.)
6. If the device to which you want to connect has already been authenticated, the **Authentication** icon  is displayed next to the device. Click **Service Discovery** for a list of available services, such as transferring files or images.

If the device to which you want to connect has not already been authenticated, a window prompt may ask if you want to authenticate the device. Follow the on-screen instructions. For more information, see [Authenticating devices](#).

BlueSpace NE – Service Discovery List

Service Discovery list area



Authenticating devices

Authentication is a security feature, which prevents unauthorized communication between Bluetooth® devices. The first time Bluetooth devices attempt to communicate with each other, a common passkey must be entered before the two devices are allowed to exchange data. If the detected device has the same passkey as your computer, then authentication is successful, and your computer can communicate with the Bluetooth device. If the detected device does not have the same passkey as your computer, authentication fails.

 A passkey is a private code entered by the user to enable two Bluetooth devices to communicate. When the same code is entered on both devices, communication becomes possible. The passkey may be changed at each communication session.

If a communication session is disconnected, you need to re-establish the passkey. Enter the passkey within approximately 30 seconds or authentication will fail.

To authenticate a Bluetooth device

1. If the **Confirmation for the authentication** window does not automatically appear, right-click the device you want to authenticate, and then click **Authentication** from the shortcut menu.

The **Confirmation for the authentication** window appears.

Confirmation for the Authentication



2. Click **Yes**.

The **Bluetooth Connection Wizard** appears.

Bluetooth Connection Wizard



3. Click **Next**.

Another **Bluetooth Connection Wizard** window appears.

Bluetooth Connection Wizard – Passkey

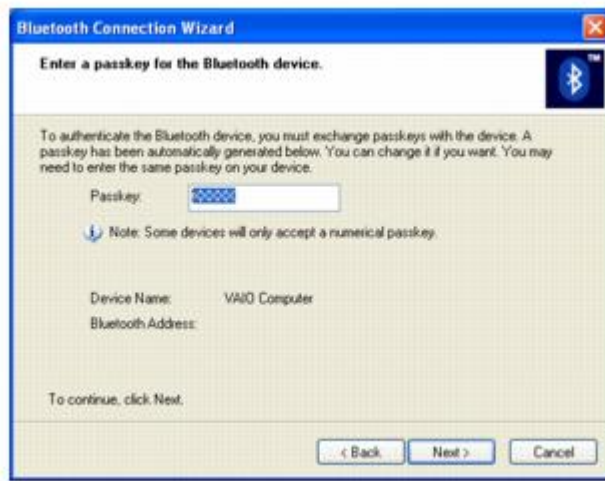

4. In the **Passkey** text box, type your own passkey or use the passkey that is provided. Click **Next**.

On the Bluetooth device in which you are trying to connect, a message may appear, stating that a Bluetooth device requires authentication. If this message appears, follow the on-screen instructions.

5. On the Bluetooth device, type the same passkey as the one entered on your computer. If the passkey is not entered within approximately 30 seconds, authentication fails.

If authentication fails, the **Bluetooth Connection Wizard** states, **The device was not authenticated**. Click **Finish**, and try the authentication procedure again.

 The passkey text box location may vary, depending on the Bluetooth device. For more information, see the documentation that accompanied the device.

6. Click **Next**.

Your computer begins the authentication process.

Bluetooth Connection Wizard – Authentication Status



You receive confirmation when the device is authenticated.

Bluetooth Connection Wizard – Authentication Completed



Renaming the Bluetooth USB Device

The Bluetooth® device installed on your computer has an assigned name that you may not recognize. Renaming this device makes it easy for you to identify your computer during authentication.

To rename the Bluetooth USB device

1. From the **Start** menu, click **Control Panel**.
2. Click **Printers and Other Hardware**, and then click **Wireless Link**.

The **Wireless Link** window appears.

3. Click the **Hardware** tab.

Wireless Link

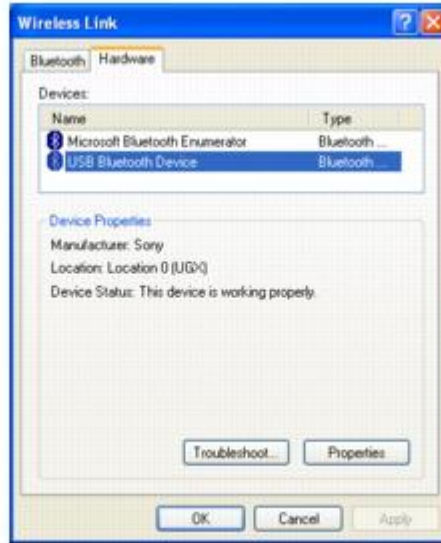

4. Select **USB Bluetooth Device**, and then click **Properties**.

The **USB Bluetooth Device Properties** window appears.

5. Click the **Advanced** tab, and type a new name in the **Name** text box.

USB Bluetooth Device Properties

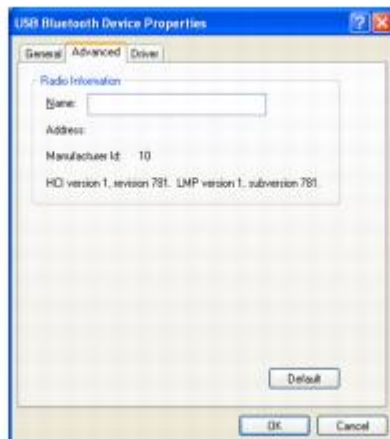

6. To see the new USB Bluetooth Device name, turn off the Bluetooth feature by moving the WIRELESS switch on your computer to **OFF**, and then restart it by moving the WIRELESS switch to **ON**.

Sending data and image files

When a connection is made between your computer and another Bluetooth® device, connection services become available. You can click Service Discovery for a list of available services that can be performed during your connection. If the File Push and Image Push icons appear, then your computer can send and receive data and image files.

 For information about services, see [Using connection services](#).

To send data files

1. Establish a connection with another Bluetooth device.

For more information, see [Establishing wireless connections](#).

2. On the **BlueSpace NE** window, click **Service Discovery**.

The **File Push** icon  appears in the **Service Discovery** area if the service is available.

3. Click the **File Push** icon  in the **Service Discovery** area.

The **Select Files to Send** window appears.

4. Select the file you want to send, and click **Send**.

The **Completed Send File** window appears when your file is received by the Bluetooth device to which your computer is connected.

Completed Send File — BlueSpace NE

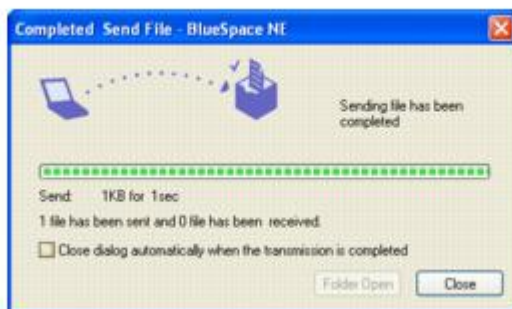

To send image files

1. Establish a connection with another Bluetooth device.

For more information, see [Establishing wireless connections](#).

2. On the **BlueSpace NE** window, click **Service Discovery**.

The **Image Push** icon  appears in the **Service Discovery** area if the service is available.

3. Click the **Image Push** icon .

The **Select Image Files to Send** window appears.

4. Select the file you want to send, and click **Send**.

A confirmation window appears when the image file is successfully sent.

When your computer receives an image, the file automatically opens.

Using connection services

When a connection is made between your computer and another Bluetooth® device, you can click Service Discovery for a list of available services that can be performed during your connection. When clicked, the purple Service Discovery icons search for a connection method.

For more information about the different services, see the BlueSpace NE help guide:

1. On the **BlueSpace NE** window, click **Help**.
2. Select **Search for topic**.

The **Help for BlueSpace NE** window appears.

 For information about the File Push and Image Push services, see [Sending data and image files](#).

Setting Bluetooth preferences

The Bluetooth Options feature enables you to set hardware preferences for discovery, connection, and authentication.

To access Bluetooth Options

1. Click **Start, Control Panel, Printers and Other Hardware**, and **Wireless Link**.

The **Wireless Link** window appears.

2. On the **Bluetooth** tab, click **Options**.

The **Bluetooth Options** window appears.

Bluetooth Options



3. Set your desired preferences, and click **OK**.

 For more information about preferences, click the **Bluetooth Connection Options** link near the bottom of the window.

Setting BlueSpace NE preferences

The BlueSpace NE Settings feature enables you to set software preferences for changing folder location, responding to device discovery, displaying windows, and more.

To set BlueSpace NE settings

1. Verify that your computer is not connected to another Bluetooth device.
2. From the **BlueSpace NE** window, click **Setting**, and then click **BlueSpace NE settings**.

The **BlueSpace NE Settings** window appears.

BlueSpace NE Settings



3. Click each tab to navigate through the window and set your preferences.

 For more information about settings, click **Help**.

Adding a Bluetooth device

Your computer can connect to several compatible Bluetooth® devices, such as printers, mobile telephones, modems for dial-up Internet connections, digital cameras, and personal digital assistants (PDAs). For specific device connection information, see the documentation that accompanied the device. You can also get connection information in the Bluetooth and BlueSpace NE help guides

To access the Bluetooth help guide

1. From the **Start** menu, click **Control Panel**.
2. **Click Printers and Other Hardware**, and then click **Wireless Link**.

The **Wireless Link** window appears.

3. From the **Bluetooth** tab, click the **Bluetooth** link near the bottom of the window.

The Bluetooth help guide appears.

4. Click **Installing and authenticating Bluetooth devices** for a list of devices.

To access the BlueSpace NE help guide

1. If the **BlueSpace NE** window is not already open, click the **Bluetooth - Standing by** icon  on the Taskbar Notification area.
2. On the **Help** menu, click **Search for topics**.

The **Help for BlueSpace NE** window appears.

Disconnecting a Bluetooth device

To disconnect or remove a device

1. If the **BlueSpace NE** window is not already open, click the **Bluetooth - Standing by** icon  on the Taskbar Notification area.
2. In the **Devices currently found** window, select the device you want to disconnect or remove.
3. From the **BlueSpace NE** window, click **Device**.
4. From the **Device** menu, click either **Remove device**, **Remove all devices**, or select an option from the **Disconnect** submenu.

Additional information

- The data transfer rate varies, depending on the following conditions:
 - Obstacles, such as walls, located between devices
 - Distance between devices
 - Material used in walls
 - Proximity to microwaves and cordless telephones
 - Radio frequency interference and other environmental conditions
 - Device configuration
 - Type of software application
 - Type of operating system
 - Use of both Wireless LAN and Bluetooth functions at the same time on the computer
 - Size of file being exchanged
- The 2.4 GHz radio frequency used by Bluetooth® and wireless LAN devices is also used by other devices. Bluetooth devices incorporate technology that minimizes interference from other devices using the same wavelength, however, communication speed and connection range may be reduced. Interference from other devices may also stop communication altogether.
- Large files may occasionally become corrupted due to radio wave interference during continuous transfer.
- All Bluetooth devices must be certified to make sure that the applicable standard requirements are maintained. Even if standards are met, individual device performance, specifications, and operation procedures can vary. Data exchange may not be possible in all situations.

Frequently asked questions

Why can't other Bluetooth devices discover my computer?

- Make sure both devices have the Bluetooth feature enabled.
- Your computer and the device may be too far apart. Wireless Bluetooth technology works best when the devices are within 32 feet (10 meters) of each other.
- The discovery option on your computer may be disabled. To ensure the discovery option is available, follow these steps:
 1. From the **Start** menu, click **Control Panel**.
 2. Click **Printers and Other Hardware**, and then click **Wireless Link**.
The **Wireless Link** window appears.
 3. On the **Bluetooth** tab, click **Options**.
The **Bluetooth Options** window appears.
 4. In the **Discovery** box, click to select the **Allow Bluetooth devices to find this computer** check box. Click **OK**.
- Your security settings may not permit a response to device discovery. To ensure your computer sends a response, follow these steps:
 1. From the **BlueSpace NE** window, click **Setting**, and then click **BlueSpace NE settings**.
 2. Click to open the **Security** tab.
 3. If it is not already selected, click to select the **Respond to Device Discovery** check box.

Why can't other Bluetooth devices connect to my computer?

- Make sure the other device is authenticated. For more information, see [Authenticating devices](#).
- Your computer may not allow connections from other devices. To enable Bluetooth device connections, follow these steps:
 1. On the **BlueSpace NE** window, click **Setting**, and then click **BlueSpace NE settings**.
 2. Click to open the **Security** tab.
 3. If it is not already selected, click to select the **Allow connection from other devices** check box.
- The incoming connections option on your computer may be disabled. To ensure the incoming connections option is available, follow these steps:
 1. From the **Start** menu, click **Control Panel**.
 2. Click **Printers and Other Hardware**, and then click **Wireless Link**.
The **Wireless Link** window appears.
 3. On the **Bluetooth** tab, click **Options**.
The **Bluetooth Options** window appears.
 4. In the **Allow Incoming Connections** box, click to select the **Allow incoming connections** check box.
 5. Click **OK**.

How will I know when another Bluetooth device is requesting authentication?

A notification prompt appears on the Windows® taskbar. To verify the notification feature is enabled, follow these steps:

1. From the **Start** menu, click **Control Panel**.
2. Click **Printers and Other Hardware**, and then click **Wireless Link**.

The **Wireless Link** window appears.

3. On the **Bluetooth** tab, click **Options**.

The **Bluetooth Options** window appears.

4. In the **Authentication Agent** box, click to select the **Enable Authentication Agent** check box. Click **OK**.

Why is my Bluetooth connection slow?

- The 2.4 GHz radio frequency used by Bluetooth and wireless LAN devices is also used by other devices. Bluetooth devices incorporate technology that minimizes interference from other devices using the same wavelength, however, communication speed and connection range may be reduced. Interference from other devices may also stop communication altogether.
- Connection availability is affected by distance and obstructions. You may need to move your computer away from obstructions or closer to the device to which it is connected.
- Identify and remove obstacles between your computer and the device to which it is connected.
- Please note that due to limitations of the Bluetooth standard, large files may occasionally be corrupted during continuous transfer due to electromagnetic interference from the environment.

Can I use a device equipped with Bluetooth technology on airplanes?

With Bluetooth technology, your computer transmits a radio frequency of 2.4 GHz. Sensitive locations, such as hospitals and airplanes, may have restrictions on the use of Bluetooth devices, due to radio interference. Check with facility staff to verify that use of the Bluetooth feature on your computer is permitted.

Inserting and Ejecting CDs or DVDs

 Avoid using adhesive labels to identify your CDs or DVDs. Adhesive labels may damage the optical drive if they come off while the disc is in the drive.

To insert a disc

1. Turn on the computer or exit a power saving mode (Standby or Hibernate) if one is active. For more information, see [Using power saving modes](#).
2. Press the drive eject button to open the drive tray.

 There are two drive eject buttons: one on the cover of the optical drive and one next to the optical drive. Use the drive eject button located next to the optical drive to open the optical drive tray.

Opening the Drive Tray

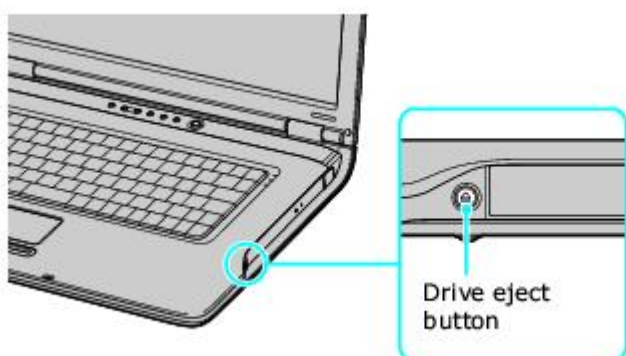

3. When the drive tray slides out, place a disc on the drive tray with the label facing up.

 You can play some DVDs on both sides. Insert this type of DVD with the side you want to play facing up.

Inserting a Disc

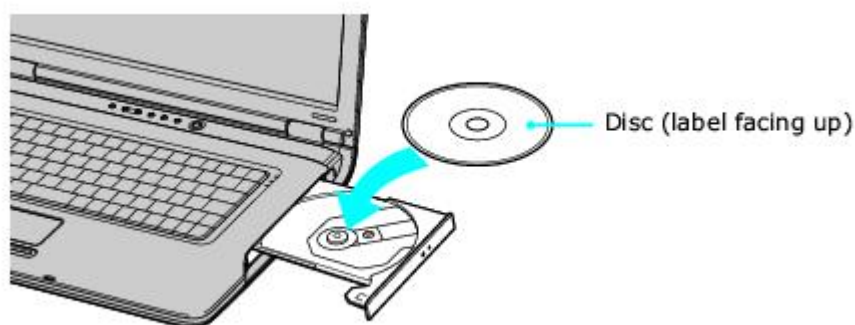

4. Press the disc onto the tray until the disc clicks securely into place.

 **If you do not seat the disc firmly over the hub, the disc may come loose while it is in the drive. A loose disc may damage the optical drive and make opening the drive tray difficult.**

5. Push the drive tray gently to close it. The Busy indicator on the drive cover blinks while your computer is reading data from the drive.

To eject a disc

1. Turn on the computer or exit a power saving mode (Standby or Hibernate) if one is active. For more information, see [Using power saving modes](#).

2. Close all programs that access the optical drive, and wait for the Busy indicator on the drive cover to turn off.
3. Press the Eject button on the drive cover to open the drive tray. The drive tray slides out.

 If the Eject button does not work, turn off the computer and insert a thin, straight object (such as a paper clip) into the manual eject hole next to the Eject button.
4. Lift the disc from the drive.
5. Push the drive tray gently to close it.

Inserting and Ejecting CDs or DVDs

 Avoid using adhesive labels to identify your CDs or DVDs. Adhesive labels may damage the optical drive if they come off while the disc is in the drive.

To insert a disc

1. Turn on the computer or exit a power saving mode (Standby or Hibernate) if one is active. For more information, see [Using power saving modes](#).
2. Press the drive eject button to open the drive tray.

 There are two drive eject buttons: one on the cover of the optical drive and one next to the optical drive. Use the drive eject button located next to the optical drive to open the optical drive tray.

Opening the Drive Tray

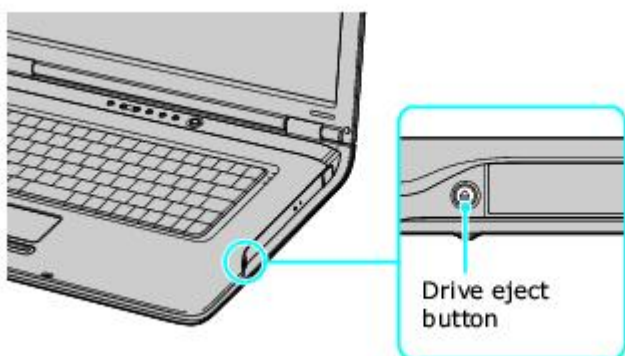

3. When the drive tray slides out, place a disc on the drive tray with the label facing up.

 You can play some DVDs on both sides. Insert this type of DVD with the side you want to play facing up.

Inserting a Disc

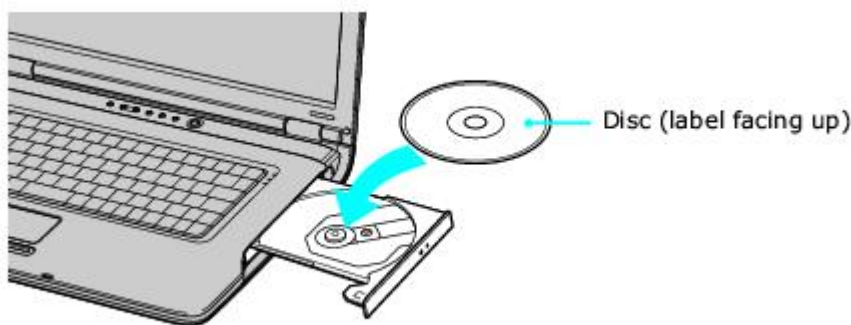

4. Press the disc onto the tray until the disc clicks securely into place.

 **If you do not seat the disc firmly over the hub, the disc may come loose while it is in the drive. A loose disc may damage the optical drive and make opening the drive tray difficult.**

5. Push the drive tray gently to close it. The Busy indicator on the drive cover blinks while your computer is reading data from the drive.

To eject a disc

1. Turn on the computer or exit a power saving mode (Standby or Hibernate) if one is active. For more information, see [Using power saving modes](#).

2. Close all programs that access the optical drive, and wait for the Busy indicator on the drive cover to turn off.
3. Press the Eject button on the drive cover to open the drive tray. The drive tray slides out.

 If the Eject button does not work, turn off the computer and insert a thin, straight object (such as a paper clip) into the manual eject hole next to the Eject button.
4. Lift the disc from the drive.
5. Push the drive tray gently to close it.

Copying and Playing CDs and DVDs

Your computer plays and records CDs and DVDs, depending on the model you purchased. Check your specifications for the type of optical drive installed on your computer and use the table below to see which types of media your optical drive supports.

Optical Drive Media (disc) Support

CD-ROM Plays CD, CD-R, and CD-RW

CD-RW Plays CD, CD-R, and CD-RW

Records to CD-R and CD-RW

CD-RW/DVD-ROM Plays CD, CD-R, and CD-RW

Records to CD-R and CD-RW

Plays DVD and most DVD-R and DVD-RW

DVD-RW Plays CD, CD-R, and CD-RW

Records to CD-R and CD-RW

Plays DVD, DVD-R, and DVD-RW

Records to DVD-R and DVD-RW

DVD±RW Plays CD, CD-R, and CD-RW

Records to CD-R and CD-RW

Plays DVD, DVD-R, DVD-RW, DVD+R and DVD+RW

Records to DVD-R, DVD-RW, DVD+R, and DVD+RW

 **Do not remove the optical drive when the computer is in a power saving mode (Standby or Hibernate). Doing so may cause the computer to malfunction.**

 If you plan to use an external optical drive, connect the drive before you launch any preinstalled CD/DVD program.

Playing CDs

Before you play an audio CD, you may need to enable your computer's audio feature.

To enable the audio feature

1. Click **Start** on the Windows® taskbar, and then click **Control Panel, Performance and Maintenance**, and **System**. The **System Properties** dialog box appears.

 As a shortcut, you can press **Fn + Windows** key  + **Insert** to open the **System Properties** dialog box.

2. Select the **Hardware** tab, and in the **Device Manager** box, click **Device Manager**. A window with a listing of the computer's hardware devices appears.
3. Double-click the optical drive device to open the submenu.
4. Double-click the listed drive, and select the **Properties** tab.
5. Click to select the **Enable digital CD audio for this CD-ROM device** check box if it is not already selected.
6. Click **OK**.

To adjust the volume for playing CDs and DVDs

Some programs have built-in volume controls, which you can adjust. If there are no volume controls, then adjust the volume of your computer's built-in speakers by using the Volume buttons, which are located above the keyboard.

- Press the left Volume button to decrease the volume.
- Press the right Volume button to increase the volume.

 An on-screen display may appear, notifying you when a change occurs.

- Use the Volume icon.

1. Double click the **Volume** icon  on the **Taskbar Notification** area. The **Volume Control** dialog box appears.
2. In the **Volume Control** and **Wave** columns, move the **Volume** sliders up to increase volume and down to decrease volume.

To play an audio CD

1. Insert the disc into the optical drive.
2. If nothing appears on the desktop once you insert an audio CD disc, then click **Start**, point to **All Programs**, and click to open a CD program, such as SonicStage® software.
If the **Audio CD** window appears, click to select an option.

Audio CD



Copying files to CDs

Before you copy files to a CD-RW or CD-R disc, read the following notes to avoid a computer malfunction and ensure the best results:

- Deactivate the screen saver and exit anti-virus software.
- Deactivate memory-resident disc utilities to avoid data loss.
- Disable the FindFast program if it is installed on your computer. Click **Start** and point to **All Programs** to see a list of programs on your computer.
- Connect and use the AC adapter to power your computer or make sure your battery is at least 50 percent charged. See [Powering Your Computer](#) for more information.

To copy files to a CD-RW or CD-R

1. Insert a blank CD-R or CD-RW disc into the optical drive.
If the **CD Drive** window appears, click **Take no action**.

CD Drive



2. Open Windows Explorer by pressing the **Windows** key  and the **E** key simultaneously.
3. In the **Folders** panel on the left, locate the file(s) or folder(s) you want to copy and either:
 - Right-click the file(s) or folder(s), point to **Send To**, and click the optical drive name.
 - Drag the file(s) or folder(s) onto the optical drive icon in the **Files Stored on This Computer** panel.
4. Close Windows Explorer.
5. Click **Start**, and **My Computer**.
6. Click the optical drive icon under **Devices with Removable Storage**. A new window appears with the file(s) or folder(s) you want to copy listed under **Files Ready to Be Written to the CD**.
7. In the **CD Writing Tasks** box, click **Write these files to CD**.
8. Follow the instructions on the **CD Writing Wizard**.

CD Writing Wizard



Do not strike or shake the computer while writing data to a disc.

¹ The read/write drive letter designation may vary, depending on your system's hardware configuration.

Playing DVDs

You can play DVDs in your computer's optical drive and view the video on a TV or other multimedia display.

Connecting your computer to a TV

Your computer is equipped with an AV Out jack, which enables you to connect your computer to a TV. To locate the AV Out jack on your computer, see [Locating Controls and Ports](#).

To connect a TV to your computer

1. Connect one end of an audio-video (AV) cable (not supplied) into the A/V OUT jack.
2. Connect the other end of the AV cable into the audio and video ports on the TV.

Connecting a TV to the Computer

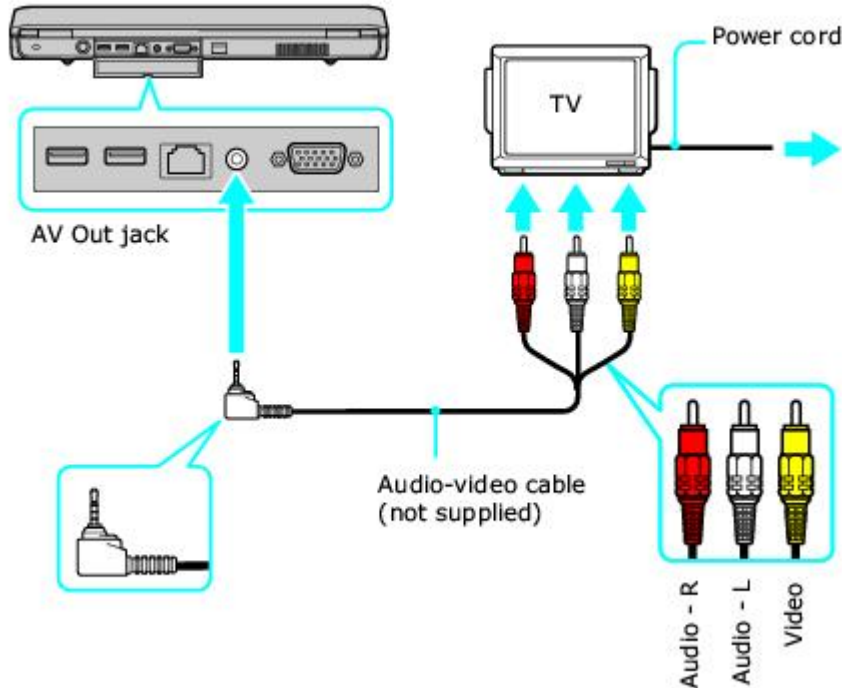

3. Switch the TV input channel to external input.

To connect a TV to the port replicator

Your computer does not recognize more than one TV connection at a time. If you connect a device using both the standard video cable and an S Video cable, the S Video connection takes precedence over the standard video connection.

 The Plug and Display feature enables you to connect an external display to the computer and instantly view an image on the connected display. If you use more than one TV connection at the same time, Plug and Display may not work properly.

Your TV may have standard video or S Video connection capability. Select one option from the following instructions.

Option 1

1. Connect an S Video cable (optional) directly into the S Video jack on your port replicator.
2. Connect the other end of the S Video cable into the appropriate port on your compatible TV.
3. Connect an audio cable with double RCA plugs at each end (optional) into the composite audio L and R jacks.
4. Switch the TV input channel to external input.

Option 2

1. Connect a video cable (optional) directly into the Video jack on your port replicator.
2. Connect an audio cable with double RCA plugs at each end (optional) into the composite audio L and R jacks on the port replicator.

3. Connect the other ends of an audio cable with double RCA plugs at each end into the appropriate jacks on your compatible TV.
4. Switch the TV input channel to external input.

 See the guide that accompanied your TV for information on how to switch to external input.

Playing DVDs on a TV

 **Do not remove the optical drive when the computer is in a power saving mode (Standby or Hibernate). Doing so may cause the computer to malfunction.**

 Connect the external optical drive if you plan to use one.

To play a DVD

1. Close all open programs.
2. Disable the screen saver and the virus checker.
3. Connect the TV to the computer. See [Connecting your computer to a TV](#) and [Selecting a display](#) for more information.
4. Open a preinstalled DVD program, such as WinDVD® software, by following these steps:
 1. Click **Start** on the taskbar, and point to **All Programs**.
 2. Select a program, such as WinDVD software, to play the DVD. For instructions on how to use a program, see the help guide included with the DVD program.
5. Select a display.
 1. Press the **Fn+F7** keys to view the image on either the computer screen (LCD) or the TV. See [Selecting a display](#) for more information.
6. Insert the DVD into the optical drive.

 Systems equipped with a CD-RW/DVD-ROM drive can read most DVD-R media.

 **Some discs recorded at 20 or 24 bits may produce noise while playing. If you have audio devices connected, this may damage your hearing and the speakers. Reduce the volume before playing a DVD.**

Do not switch power saving modes while the computer is playing a DVD.

Do not use memory-resident utility software to speed up disc access when playing a DVD. This may cause the computer to malfunction.

Disconnecting your computer from a TV

Simply unplug the audio-video (AV) cable from the AV Out jack on the computer.

Playing DVDs on your computer

Your computer is equipped with an optical drive that enables you to watch DVDs and most DVD-R discs on your computer.

To play a DVD

1. Close all open programs.
2. Insert the DVD into the optical drive.
3. Open a preinstalled DVD program, such as WinDVD® software, by following these steps:
 1. Click **Start** on the taskbar, and point to **All Programs**.
 2. Select a program, such as WinDVD software, to play the DVD. For instructions on how to use a program, see the help guide included with the DVD program



Some discs recorded at 20 or 24 bits may produce noise while playing. If you have audio devices connected, this may damage your hearing and the speakers. Reduce the volume before playing a DVD.

Do not switch power saving modes while the computer is playing a DVD.

Do not use memory-resident utility software to speed up disc access when playing a DVD. This may cause the computer to malfunction.

Copying files to DVDs (on selected models only)

Use the table shown on [Copying and Playing CDs and DVDs](#) to see which type of DVD media your computer supports.

To copy files to a DVD-R or DVD-RW

1. Connect the AC adapter to the computer. See [Connecting the AC adapter](#) for more information.
2. Insert the disc into the optical drive. See [Inserting and Ejecting CDs or DVDs](#) for more information.
3. Click **Start, All Programs**, and select the DVD software program you want to use from the submenu.

 You can also reference the online help guides supplied with the program.

 **Do not strike or shake the computer while copying files to a disc.**

Printer Connections

Your computer is compatible with many popular printers. However, to ensure the best performance, printers must be compatible with the Microsoft® Windows® operating system installed on your computer.

Connecting a USB Printer

You can connect a universal serial bus (USB) printer to your computer. The New Hardware Wizard enables you to easily install the printer software, but some printers require separate driver software installation. See the instructions that accompanied your printer for more information.

To connect a USB printer

1. Plug the USB cable into the USB port  on your computer or port replicator, if applicable. See "Locating Controls and Ports" in the "Setting Up" chapter of your printed VAIO® Computer Quick Start.
2. Plug the other end of the USB cable into the USB port on the printer. The **Found New Hardware Wizard** appears.

Connecting a USB Printer

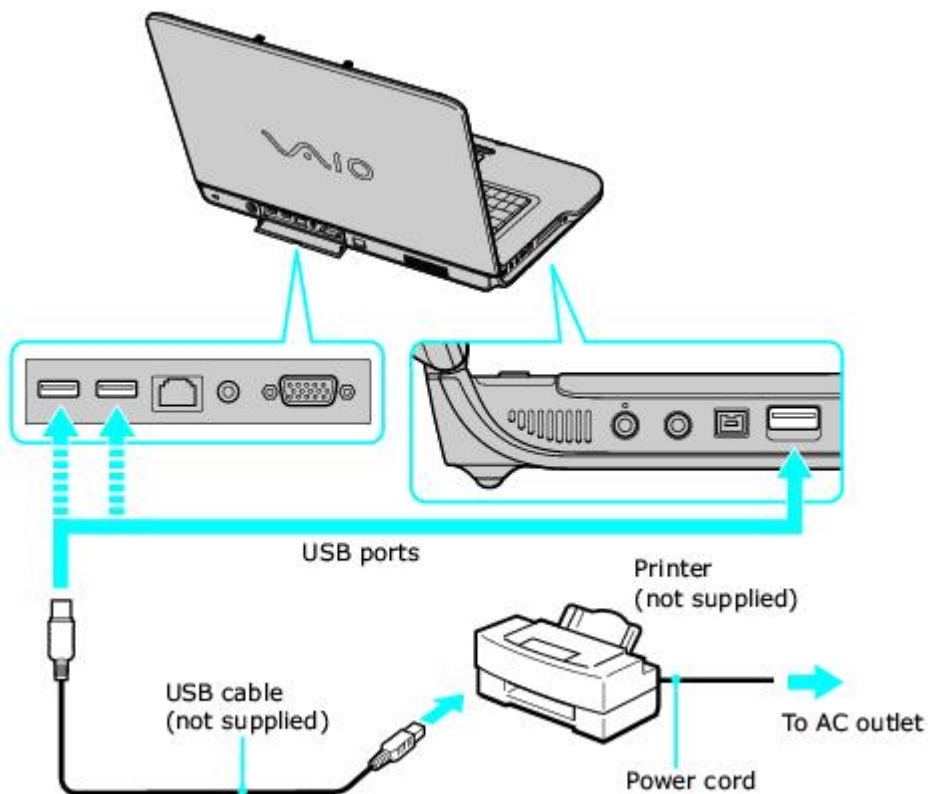

 See the guide that accompanied the printer for more information on its installation and use.

Connecting a Parallel Printer

You can connect a parallel port printer to your port replicator if your computer came with one. The new hardware wizard enables you to easily install the printer software, but some printers require separate driver software installation. See the instructions that accompanied your printer for more information.

 The printer port on this port replicator is intended for printer connections only.

To connect a parallel port printer

1. Plug the printer cable into the Printer port  on your computer or port replicator, if applicable. See [Locating Controls and Ports](#) for more information.
2. Plug the other end of the printer cable into the port on the printer.
3. Restart your computer by clicking **Start, Turn Off Computer**, and **Restart**. If the **New Hardware Wizard** appears, follow the on-screen instructions.
4. Make sure the computer recognizes the printer. Follow these steps:
 - Click **Start, Control Panel, Printers and Other Hardware**, and then **Printers and Faxes**. If the computer recognizes the printer, it will be listed in the **Printers and Other Hardware** window. If the computer does not recognize the printer, you may need to install the printer driver software. See the guide that accompanied the printer for more information.

Connecting a Parallel Printer

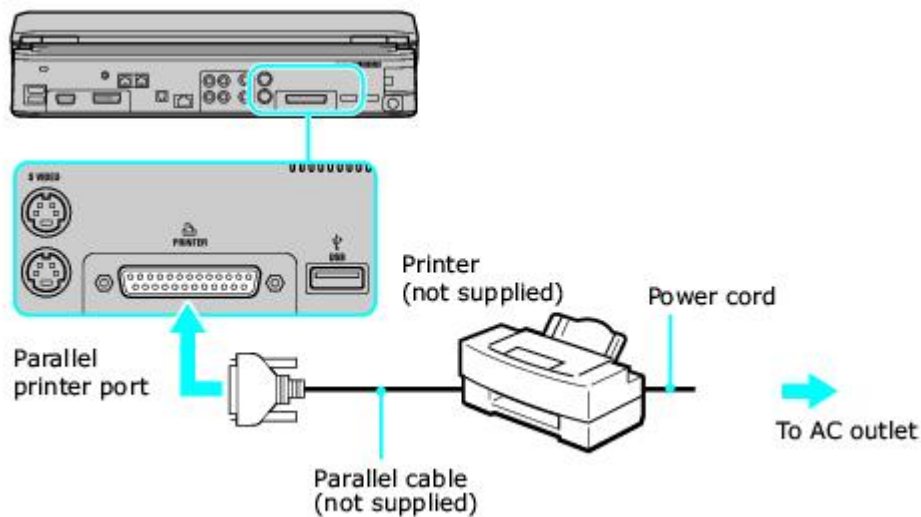

 See the guide that accompanied the printer for more information on its installation and use.

Disconnecting a Printer

You can disconnect the printer cable when the computer is on or off. Disconnecting a printer when the computer is in a power saving mode (Standby or Hibernate) may cause the computer to malfunction.

To disconnect a printer

- Unplug the printer cable from the computer.

Using Memory Stick Media

Your VAIO® computer is equipped with a Memory Stick® slot that supports certain types of Memory Stick® media.

About Memory Stick media

Memory Stick® media are a compact, portable, and versatile data storage media designed for exchanging and sharing digital data with compatible devices. You can store different data formats on a single Memory Stick media. The following types of Memory Stick media are available, but compatibility with your computer can vary.

- **MagicGate Memory Stick media** — Provides copyright protection with authentication and encryption, using Sony® MagicGate technology. Authentication ensures that protected content is only transferred between compliant devices and media. Protected content can be recorded and transferred in an encrypted format to prevent unauthorized duplication or playback.
- **Memory Stick PRO media** — Provides MagicGate copyright protection and high-speed transfer features when used with compatible Memory Stick PRO devices. VAIO® computers support Memory Stick PRO media for data storage purposes only. Currently, MagicGate technology features, such as authentication and encryption, are not available.
- **Memory Stick media** — Provides data storage only. The Memory Stick media does not provide MagicGate technology or high-speed data transfer.

Currently, Sony® SonicStage® and OpenMG software are not compatible with Memory Stick PRO media. Sony suggests using only MagicGate Memory Stick media to store and transfer any data created with SonicStage or OpenMG software.

Visit the Sony Computing Support Web site at <http://www.sony.com/pcsupport> regularly for the latest information on Memory Stick PRO media.

 Memory Stick media do not support video file playback directly from the media. Copy the video file to your hard disk drive and then play back the file.

Inserting Memory Stick media

Before using Memory Stick® media, back up important data. The media slot accommodates only one Memory Stick media at a time.

To insert Memory Stick media

1. Insert the Memory Stick media with the arrow facing up and toward the Memory Stick media slot.

⚠ Do not insert more than one Memory Stick media into the Memory Stick media slot. Inserting the media improperly may damage the computer.

 The Memory Stick media slot supports Memory Stick Duo media with or without the adapter.

2. Carefully slide the Memory Stick media into the slot until it clicks in place. The Memory Stick media indicator briefly blinks.

Inserting Memory Stick Media

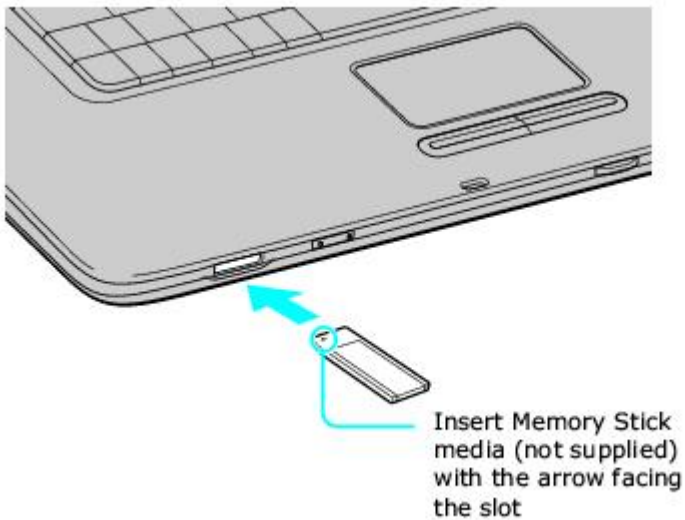

Viewing the contents

Depending on the model you purchased, the Sony Memory Stick window may appear when you insert a Memory Stick® media. From this window, you can choose to view, print, copy or organize your images or data stored on the Memory Stick media. If the Sony Memory Stick window does not appear when you insert your Memory Stick media, then follow these steps:

To view the contents

1. From the **Start** menu, click **My Computer**. The **My Computer** window appears.
2. Click **Sony MemoryStick**. The **Sony MemoryStick** window appears, displaying the contents stored on the Memory Stick media.

Protecting data on Memory Stick media

Some Memory Stick® media are equipped with a write-protect tab¹. The write-protect tab prevents accidental changes to information recorded on your Memory Stick media. When you slide the write-protect tab to the LOCK position, your Memory Stick media is write-protected. You cannot delete, copy, or save information on the media while the write-protect tab is in the LOCK position. When you slide the tab to the un-LOCK position, you can write to or modify your Memory Stick media's contents.

Write-protect off Data can be saved on the Memory Stick media.

Write-protect on Data can be read from but not saved on the Memory Stick media.

Using the Write-Protect Tab

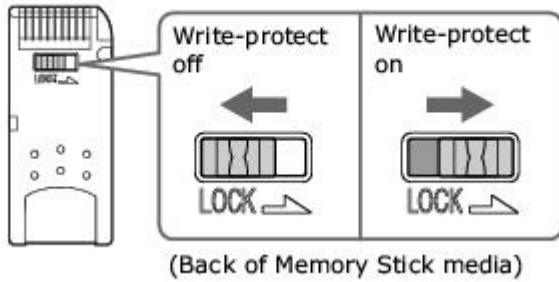

¹ Some Memory Stick media do not have a write-protect tab, and the location or position of the write-protect tab may vary, depending on the type of Memory Stick media. See the information sheet provided with your Memory Stick media.

Formatting Memory Stick media

Memory Stick® media is formatted for immediate use when you purchase it. If you need to reformat Memory Stick media, use the Memory Stick Formatter that is provided with the media. For more information about using Memory Stick Formatter, refer to Formatter Help.

 **Formatting Memory Stick media erases all data, including music data, previously saved to it. Before you reformat Memory Stick media, confirm that the media does not contain files you want to keep. Back up important data before formatting the media.**

To format Memory Stick media

1. Insert the Memory Stick media into the Memory Stick media slot. See [To insert Memory Stick media](#) for more information.
2. From the **Start** menu, click All Programs, select **Memory Stick Utility**, and click **Memory Stick Formatter**. The **Memory Stick Formatter** window appears.
3. Click **Start Format**, and follow the on-screen directions.
4. After formatting, click **Exit**.

Removing Memory Stick media

If the Memory Stick® media is removed prematurely, a blue screen with a message may appear prompting you to continue or exit. Reinsert the media into the slot and press **Enter** to continue. This enables the media to finish reading or writing data.

To remove Memory Stick media

1. Wait a minimum of 10 seconds after the Memory Stick media finishes reading or writing data before removing the media.
2. Make sure the access light is off.
3. Push the Memory Stick media in toward the computer.
4. When the Memory Stick media ejects, pull it out.

 Be careful when removing the Memory Stick media, as it may not eject completely from the slot.

Using a Floppy Disk Drive

You can connect a floppy disk drive to your computer. The floppy disk drive enables you to read or write data to a floppy disk.



Using a Floppy Disk Drive

You can connect a floppy disk drive to your computer. The floppy disk drive enables you to read or write data to a floppy disk.

Connecting a floppy disk drive

You can connect a floppy disk drive when your computer is on or off. Connecting the drive when the computer is in a power saving mode (Standby or Hibernate) may cause the computer to malfunction.

To connect a USB floppy disk drive

1. Close any active programs to prevent data loss.
2. Plug the USB cable (with the USB icon  facing upward) into the USB port . The **Found New Hardware** pop-up message appears.

Connecting a Floppy Disk Drive

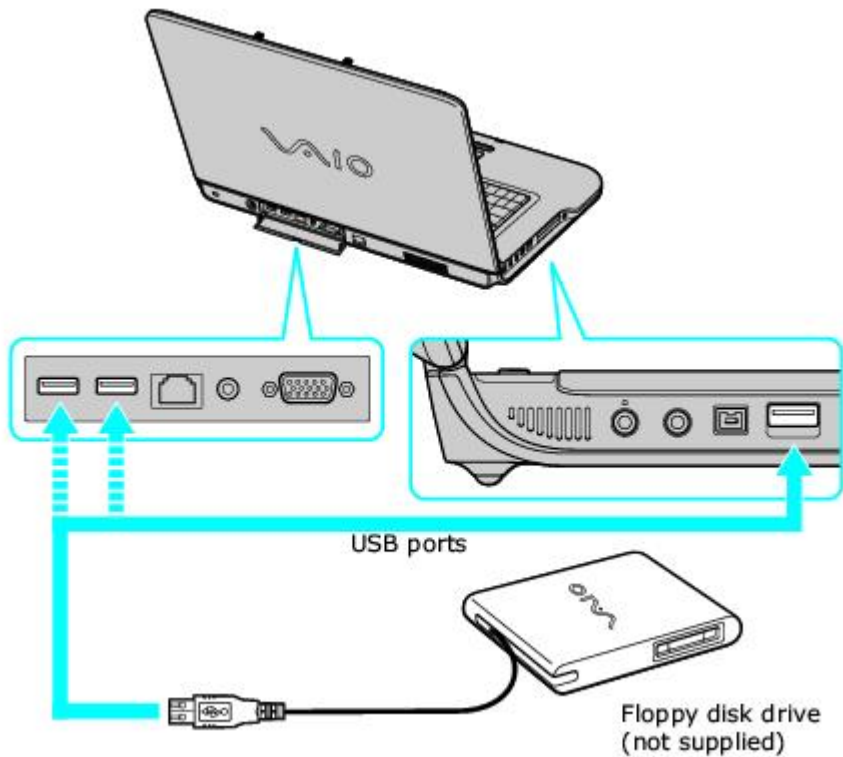

Inserting and removing floppy disks

To write data to a disk, use one that is not write-protected or disable the write-protect feature. The floppy disk drive cannot write data to a disk if it is inserted into the drive improperly.

To insert a floppy disk

1. Hold the floppy disk with the label facing up.
2. Push the floppy disk into the drive until it clicks into place.

Inserting a Floppy Disk



 Do not open the shutter manually and touch the surface of the floppy disk.

To remove a floppy disk

1. Close all programs that access the floppy disk.
2. Wait for the LED indicator on the floppy disk drive to turn off.
3. Push the Eject button, and remove the disk.

 To avoid losing data, do not push the Eject button when the LED indicator is on.

Removing a Floppy Disk

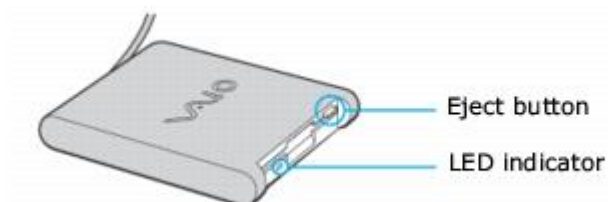

Protecting floppy disks

- Do not open the shutter manually or touch the surface of the floppy disk.
- Keep floppy disks away from magnets, direct sunlight, and heat sources.

Disconnecting a floppy disk drive

You can disconnect a USB floppy disk drive when the computer is on or off. Disconnecting the drive when the computer is in a power saving mode (Standby or Hibernate) may cause the computer to malfunction.

1. Close all programs accessing the floppy disk drive.
2. Double-click the **Safely Remove Hardware** icon  on the taskbar. The **Safely Remove Hardware** window appears.
3. Select the **floppy disk drive in the Hardware devices window, if it is not already selected.**
4. Click **Stop**. The **Stop a Hardware device** window appears.
5. Make sure the **floppy disk drive is selected**, and click **OK**. A message appears stating it is now safe to remove the hardware device.
6. Remove the floppy disk drive from the computer.

Storing a floppy disk drive

Fold the floppy disk drive cable and connector into the side compartment on the floppy disk drive.

Storing a Floppy Disk Drive



Using PC Cards

Your computer includes one PC Card slot. A PC Card enables you to connect devices such as an optical drive or floppy disk drive.

 See your VAIO® Computer Specifications for the type of PC Card that is compatible with your computer. These slots are compatible with CardBus. You do not need to turn off your computer to insert or remove a PC Card.

Inserting PC Cards

Some PC Cards may require you to disable idle devices when using the PC Card. You can use Sony Notebook Setup to disable these devices.

To open Sony Notebook Setup

1. Click **Start** on the Windows taskbar, and then click **All Programs**.
2. Point to **Sony Notebook Setup**, and click **Sony Notebook Setup**. The **Sony Notebook Setup** dialog box appears.

To insert a PC Card

1. Make sure the front label of the PC Card is facing up.
2. Push the PC Card gently into the slot. The system automatically detects the PC Card.



Do not force a PC Card into the slot; this may damage the connector pins.

When a PC Card is inserted, do not place your computer in a bag or case. Pressure or shock to a PC Card may damage your computer.

Touching the head of the PC Card will not damage the connector pins, but damage may occur if the head of the PC Card is sticking out of the PC Card slot while the computer is being transported.

Inserting a PC Card

Insert the PC Card
(not supplied) with
the arrow facing
the slot

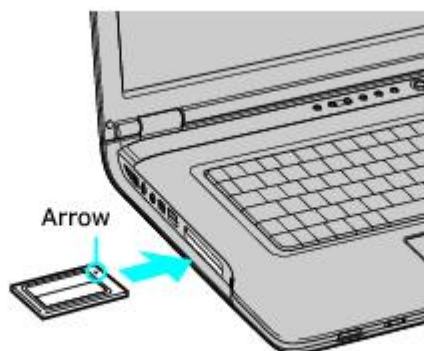

Removing PC Cards

You can remove PC Cards while the computer is on or off. PC Cards draw power from the computer when they are inserted into the PC Card slot, whether or not you use the card.

If you are not using your PC Card and you are using a battery as a power source, remove the PC Card from the PC Card slot to conserve battery power.

To remove a PC Card while your computer is on

1. Double-click the **Safely Remove Hardware** icon  on the taskbar. The **Safely Remove Hardware** dialog box appears.
2. Click to select the PC Card in the **Hardware devices** window, if it is not already selected.
3. Click **Stop**. The **Stop a Hardware device** window appears.
4. Make sure the PC Card is selected, and click **OK**. A message appears stating it is safe to remove the hardware device.
5. Push the Release button. The Release button pops out.
6. Push the Release button a second time. The PC Card pops out.
7. Gently pull the card out of the slot.

To remove a PC Card while the computer is off

1. Push the Release button once. The Release button pops out.
2. Push the Release button a second time. The PC Card pops out.
3. Gently pull the card out of the slot.

Using i.LINK Digital Video Recorders

You can connect a digital video (DV) recorder, such as an i.LINK[®]¹ digital video camera recorder, to the i.LINK[®] S400  (IEEE 1394) port on your computer. The i.LINK digital-video camera recorder is an external device that can be connected to your computer via IEEE 1394 interface and enables you to record and view digital images.

¹ i.LINK is a trademark of Sony used to designate that a product contains an IEEE 1394 connector. The i.LINK connection may vary, depending on the software application, operating system, and compatible i.LINK devices. All products with an i.LINK connection may not communicate with each other. Refer to the documentation that came with your compatible i.LINK device for more information on operating conditions and proper connection. Before connecting compatible i.LINK PC peripherals to your system, such as a CD-RW or hard disk drive, confirm their operating system compatibility and required operating conditions.

Using i.LINK Digital Video Recorders

You can connect a digital video (DV) recorder, such as an i.LINK[®]¹ digital video camera recorder, to the i.LINK[®] S400  (IEEE 1394) port on your computer. The i.LINK digital-video camera recorder is an external device that can be connected to your computer via IEEE 1394 interface and enables you to record and view digital images.

¹ i.LINK is a trademark of Sony used to designate that a product contains an IEEE 1394 connector. The i.LINK connection may vary, depending on the software application, operating system, and compatible i.LINK devices. All products with an i.LINK connection may not communicate with each other. Refer to the documentation that came with your compatible i.LINK device for more information on operating conditions and proper connection. Before connecting compatible i.LINK PC peripherals to your system, such as a CD-RW or hard disk drive, confirm their operating system compatibility and required operating conditions.



Connecting an i.LINK digital video recorder

You can connect an i.LINK digital video (DV) recorder when the computer is on or off. Connecting the DV recorder when the computer is in a power saving mode (Standby or Hibernate) may cause the computer to malfunction.

Before you connect an i.LINK digital video recorder

- Do not connect more than one digital video camera recorder at a time. The preinstalled programs on your computer will not recognize multiple cameras.
- Do not connect an external device that requires power from the i.LINK port. The i.LINK port does not supply power to the external device.
- The i.LINK port supports transfer rates of up to 400 Mbps; however, the actual transfer rate is the lowest transfer rate of the external device.
- The i.LINK features available may vary depending on the programs you use. See the help guide that accompanied your program for more information.

To connect an i.LINK digital video recorder

1. Turn on the digital video (DV) device and the computer.
2. Plug the i.LINK® cable into the i.LINK port  on the DV device.
3. Plug the other end of the i.LINK cable into the i.LINK port  on your computer. The **Found New Hardware** window appears on the lower right corner of your screen.

Connecting an i.LINK Digital Video Camera Recorder

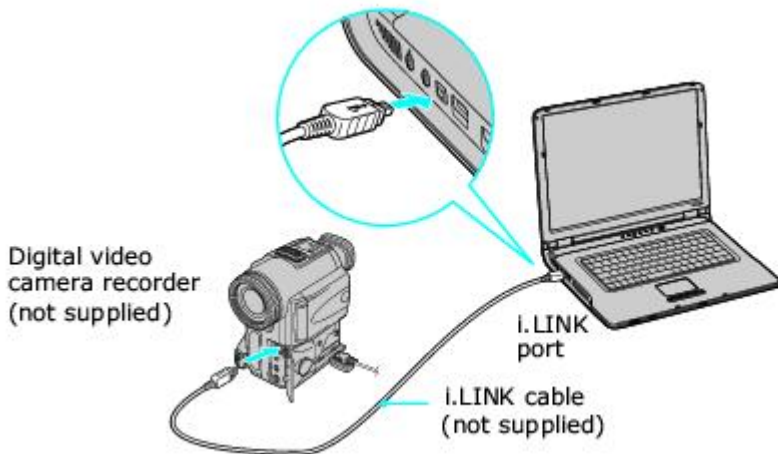

 See the guide that accompanied your digital video camera recorder for more information on its installation and use.

Disconnecting the i.LINK digital video recorder

You can disconnect the digital video recorder while the computer is on or off. Simply unplug the i.LINK cable from the i.LINK port on the computer. Disconnecting the cable when the computer is in a power saving mode (Standby or Hibernate) may cause the computer to malfunction.

Using a digital video camera recorder

Your computer comes with preinstalled driver software that is compatible with most Sony digital video camera recorders. If you purchased a camera that comes with its own driver software, install these drivers before you use the camera.

To view images

You can view images captured by your digital video camera recorder three different ways. Select one set of instructions from the following list:

- If your digital video camera recorder is compatible with the preinstalled programs, the **Digital Video Device** window appears when you connect the camera to the computer. Select the program you want to use in this window, and click **OK**.
- Click **Start**, and click **All Programs**. Select a program in which to view your images.
- Click **Start**, and click **Welcome to VAIO life**. Click **Movies**, and select a program in which to view your images.

You can connect an external display (such as a computer monitor or a projector) to your computer.

Connecting a computer monitor

Your computer can display images to the computer screen (LCD), to an external computer monitor, or to both the LCD and external monitor while your computer is on.

To connect a computer monitor

1. Make sure the computer monitor is plugged into an AC outlet.
2. Plug the display cable into the Monitor (VGA) port  on the computer.
3. If it is not already on, turn on the computer monitor.
4. Press the **Fn+F7** keys to toggle the display between your computer, the monitor, or both the computer and monitor.

 You cannot use the Monitor (VGA) port on your computer when a port replicator is connected to the computer. Use the Monitor (VGA) port on the port replicator instead.

Connecting a multimedia device

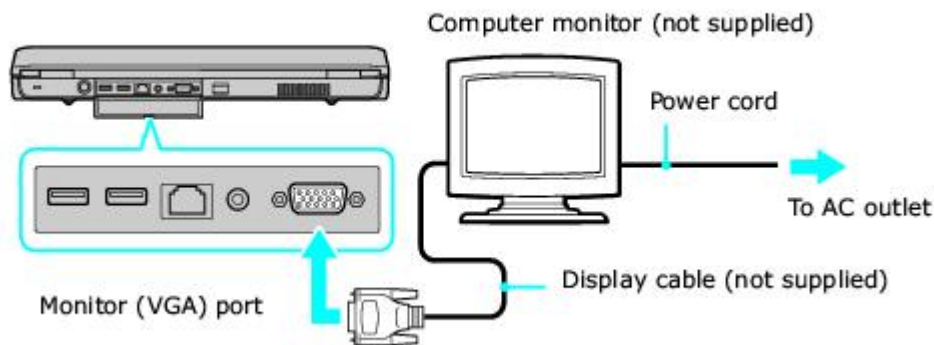

Connecting a Computer Monitor



You can connect a multimedia device, such as a multimedia computer monitor or projector, to your computer. Connecting a multimedia device enables you to display images on your computer screen (LCD), the multimedia device, or both.

 For information on connecting a TV to your computer, see [Playing DVDs](#).

To connect a multimedia computer monitor or projector

1. Plug the device into an AC outlet.
2. Plug the device cable into the Monitor (VGA) port  on your computer. If you are using a multimedia computer monitor, which has built-in speakers and a microphone, plug the audio cable into the Headphone jack  on your computer to hear sound.

 To locate the Monitor port and Headphone jack, see "Locating Controls and Ports" in the "Setting Up" chapter of your printed VAIO® Computer Quick Start.

3. Turn on the device (if it is not already on), and then turn on your computer.

Connecting a Projector

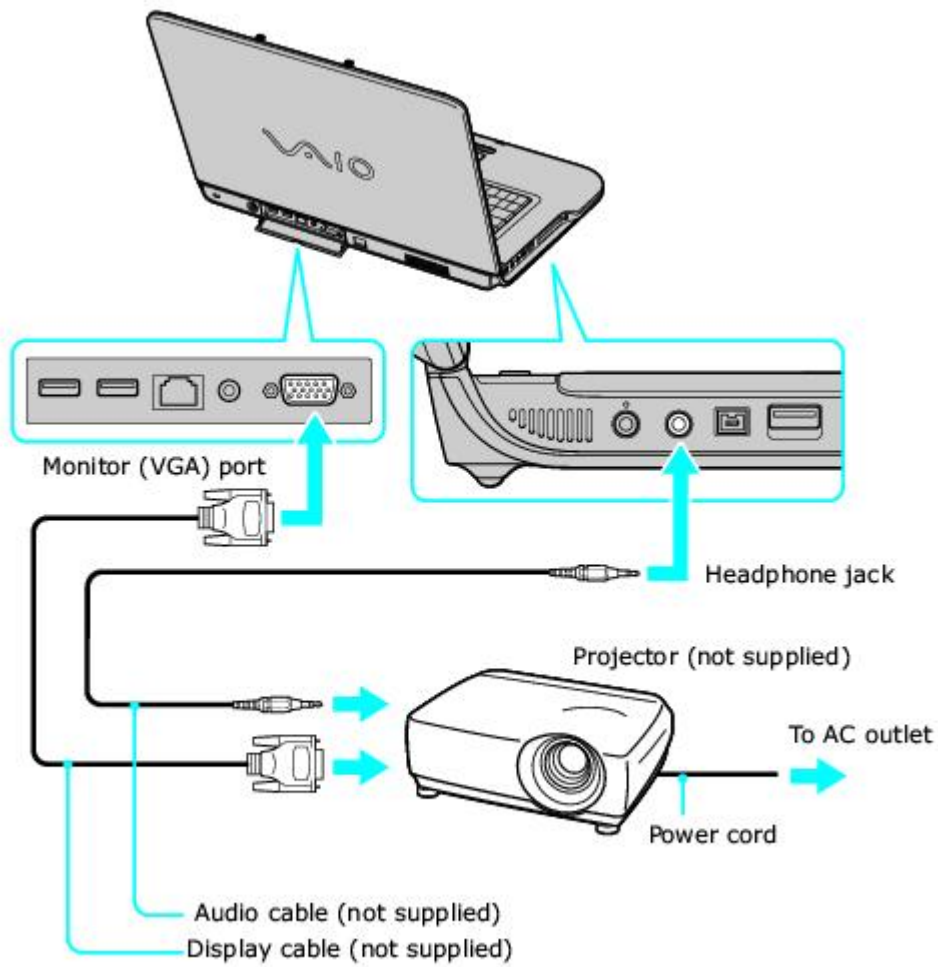



4. Press the **Fn+F7** key combination to toggle the display between your computer, the monitor, or both. See [Selecting a display](#) for more information.

 See the guide that accompanied your projector for more information on its installation and use.

Selecting a display

Your computer comes with a Plug and Display feature, which enables you to connect an external display to the computer and instantly view an image on the connected display. An external display can be a projector, computer monitor, or TV.

When you connect an external display, the Plug and Display icon  appears in the Windows® taskbar and the image appears on both the computer's LCD screen and the external display.

 Clicking the Plug and Display icon  launches Sony Notebook Setup, where you can customize the Plug and Display settings.

To switch the display between the computer screen (LCD), the external display, or both, use the Fn+F7 shortcut keys or the S1 button. See [Using the S1 button](#) for more information.

Shortcut keys Result

Fn+F7 Toggles the display between the computer screen (LCD), a connected external display, and both the LCD and an external display. You can also select the Setup option to adjust the Plug and Display settings. Select one display (LCD or an external display) when playing a DVD.

 You may not be able to display the computer screen (LCD) and an external display or projector at the same time, depending on the types of computer displays and projectors you are using.

Plug and Display customizes the screen resolution to fit within the external display. However, if the external display's screen resolution is larger than the computer's LCD screen resolution, Plug and Display adjusts both images to the largest resolution shared by both devices. If the image is distorted, you can always adjust the screen resolution manually.

To adjust the screen resolution

1. Click the **Start** menu and then click **Control Panel**.
2. Click **Appearance and Themes** and then click **Display**.
3. When the **Display Properties** window appears, select the **Settings** tab.
4. Use the slider in the **Screen resolution** box to adjust the screen resolution.

 Plug and Display may not work properly if you use more than one TV connection at the same time.

Disconnecting a computer monitor or projector

You can disconnect the external computer monitor or projector by unplugging the monitor (VGA) cable from your computer's port. Disconnecting the external display when the computer is in a power saving mode (Standby or Hibernate) may cause the computer to malfunction.

Using Speakers

Your computer comes with built-in stereo speakers and selected models with an A/V port replicator come with external speakers. If your computer did not come with additional speakers and you wish to enhance the sound quality of your computer, shop Sony online at <http://www.sonystyle.com/vaio> or contact your local retailer. Make sure the speakers are designed for computer use.

 See [Connecting the speakers with built-in infrared receiver](#) for instructions about how to connect external speakers supplied with the A/V port replicator.

Connecting speakers

You can connect external speakers to your computer to enhance the sound quality of your computer.

⚠ Do not place floppy disks on the speakers. The speakers' magnetic field may damage the data stored on the floppy disks.

To connect speakers to your computer

1. Turn down the volume of the speakers.
2. Plug the speaker cable into the Headphone jack  on the computer.
3. Plug the other end of the speaker cable into the speaker.

Connecting Speakers

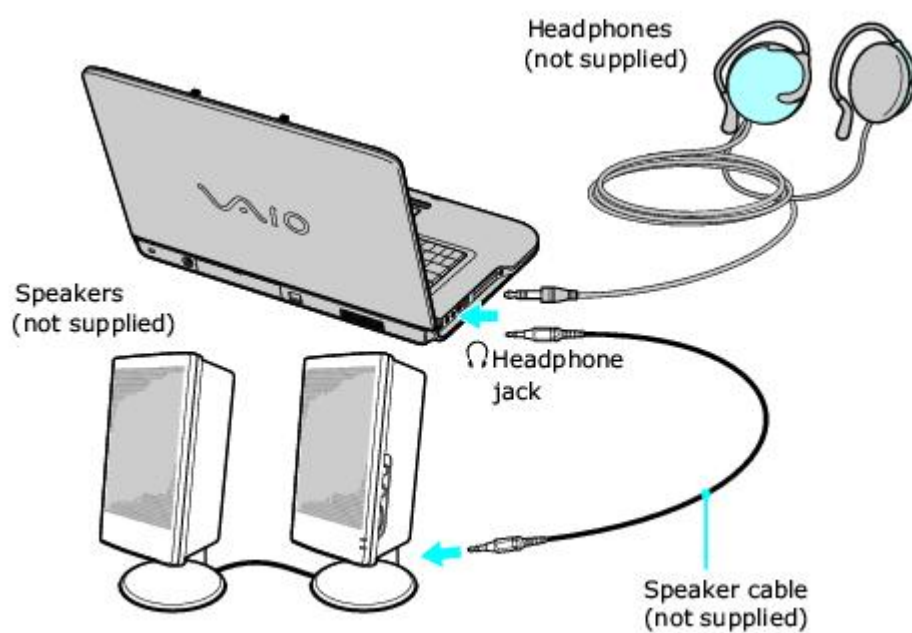

 See the guide that accompanied your speakers for more information on its installation and use.

Disconnecting speakers

You can disconnect external speakers when the computer is on or off. Simply unplug the speaker cable from the Headphone jack  on the computer.

Adjusting the sound

To increase and decrease the volume for playing CDs and DVDs, use the Volume buttons. You can also use the Mute button to enable and disable the sound. The Volume buttons and the Mute button are located above the keyboard.

Locating the Sound Buttons

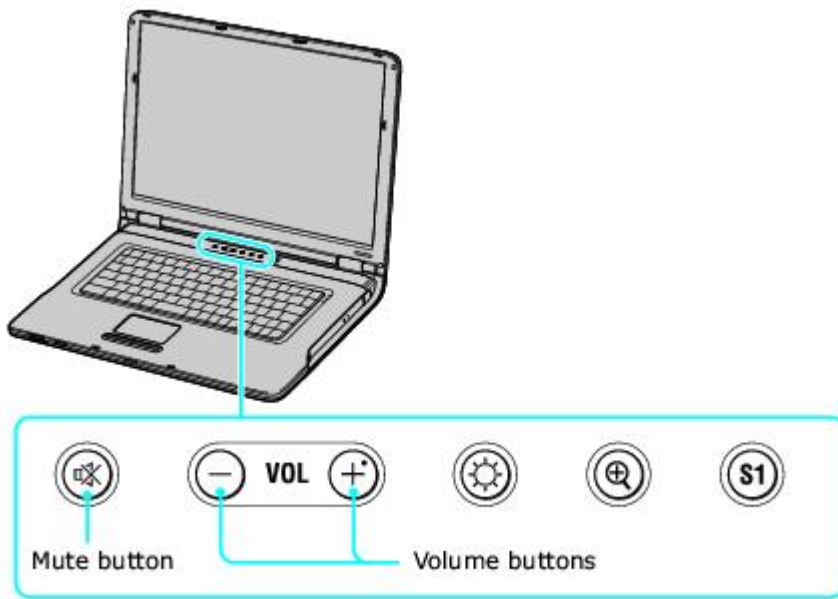

Alternatively, you can use the **Volume** icon  on the Windows® taskbar to adjust the sound.

To adjust the sound using the Volume icon

1. Right-click the **Volume** icon  on the Windows® taskbar, and select **Open Volume Control**. The **Volume Control** window appears.
2. Click and drag the **Volume Control** slider up to increase volume and down to decrease volume.
3. Click to cancel any **Mute** check boxes that are selected.

Sound device Function

Volume Control	Adjust the sound level from the speakers or headphones.
Wave	Adjust the wavfile sound or the system sound of Windows.
SW Synth	Adjusts the internal or external synthesizer volume.
CD Player	Adjust the volume of the CD in the optical drive.
Microphone	Adjust the internal or external microphone volume.
PC Beep	Adjust the beep sound when inserting or removing the PC Card and other devices.
Line In ¹	Adjusts the sensitivity of input volume.

¹ On selected models only.

Enabling the sound

If you do not hear sound when playing a CD or DVD, the sound may be muted. Press the Mute button located above the keyboard. The Mute button toggles the audio output on and off. If you still cannot hear sound, you may need to enable the audio feature.

To enable the audio feature

1. Click **Start** on the Windows® taskbar, and click **Control Panel**.
2. Click **Performance and Maintenance**, and click **System**. The **System Properties** window appears.
3. Select the **Hardware** tab, and click **Device Manager**. The **Device Manager** window, which lists the hardware devices, appears.
4. Double-click the name of the optical drive, such as **DVD/CD-ROM drives**¹.
5. Double-click the listed drive name, and click the **Properties** tab.
6. Click the **Enable digital CD audio for this CD-ROM device** check box if it is not already selected.

¹The read/write drive letter designation may vary, depending on your system's hardware configuration.

Using Microphones

You can connect an external microphone to your computer to enhance the sound input to your computer. Make sure your microphone is designed for computer use. If you wish to purchase a microphone, shop Sony online at <http://www.sonymstyle.com/vaio> or contact your local retailer.

Connecting a microphone

Plug the microphone cable into the Microphone jack¹ on the computer.

Connecting a Microphone

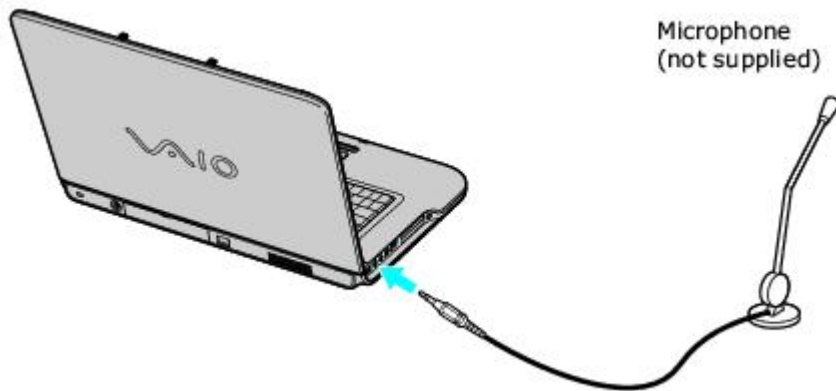

 See the guide that accompanied your microphone for more information on its installation and use.

¹ A protruding dot located next to the Microphone jack distinguishes this jack from the Headphone jack.

Disconnecting a microphone

You can disconnect an external microphone when the computer is on or off. Simply unplug the microphone cable from the Microphone jack  on the computer.

Using a microphone to record sound

You can record messages, memos, etc. by connecting a microphone to the Microphone jack¹ on your computer.

To record from a microphone

1. Double-click the **Volume** icon  on the Windows® taskbar. The **Volume Control** window appears.
2. From the **Options** menu, click **Properties**. The **Properties** dialog box appears.
3. Click to select the **Recording** option in the **Adjust volume for** box, and click **OK**. The **Recording Control** window appears.
4. Click the **Select** check box at the bottom of the **Microphone** column, if it is not already selected. Close the **Recording Control** window.
5. Click **Start**, and select **All Programs, Accessories, Entertainment**, and then **Sound Recorder**. The **Sound - Sound Recorder** window appears.

 For help using Sound Recorder, click **Help** in the **Sound Recorder** window.

To adjust the volume for recording sound

You can only adjust the volume for recording in the **Recording Control** window.

1. Right-click the **Volume** icon  on the taskbar, and select **Adjust Audio Properties**.
2. On the **Audio** tab, click **Volume** in the **Sound recording** box. The **Recording Control** window appears.
3. Click and drag the **Microphone** slider up to increase volume and down to decrease volume.

¹A protruding dot located next to the Microphone jack distinguishes this jack from the Headphone jack.

Connecting the Port Replicator

Locating Ports and Jacks

A port replicator is a device that attaches to your computer and contains additional jacks and ports, such as USB ports. A port replicator may come with your computer, depending on the model you purchased. If you wish to purchase a port replicator, shop Sony online at <http://www.sonymstyle.com/vaio> or contact your local retailer.

 The printer port on this port replicator is intended for printer connections only.

A/V Port Replicator

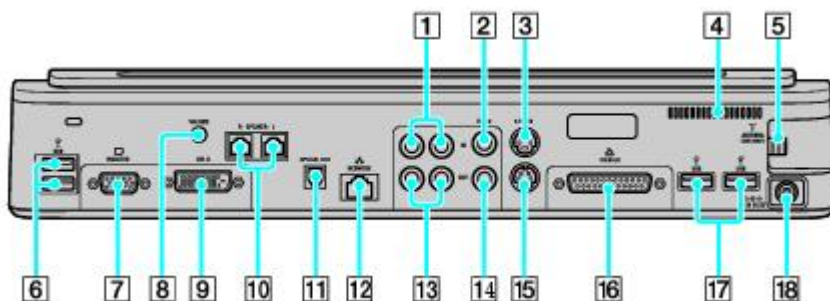

1 Composite Audio In jacks **10** Speaker jacks (right and left)

2 Composite Video In jack **11** Optical Out port
Output frequency (48 kHz¹/44 kHz)

3 S Video In port **12** Network (Ethernet) port (10BASE-T / 100BASE-TX / 1000BASE-TX²)

4 Air vent **13** Composite Audio Out jacks

5 VHF/UHF port **14** Composite Video Out jack

6  USB 2.0 ports³ **15** S Video Out port

7 Monitor (VGA) port **16** Printer port

8 Volume jack **17**  USB 2.0 ports³

9 DVI-D port **18** DC IN port

¹ Output frequency is 48 kHz for all frequencies except 32 kHz and 44.1 kHz.

² Only selected models support a 1000BASE-TX connection.

³ Supports high-/full-/low- speeds.

 The printer port on this port replicator is intended for printer connections only.

Business Port Replicator

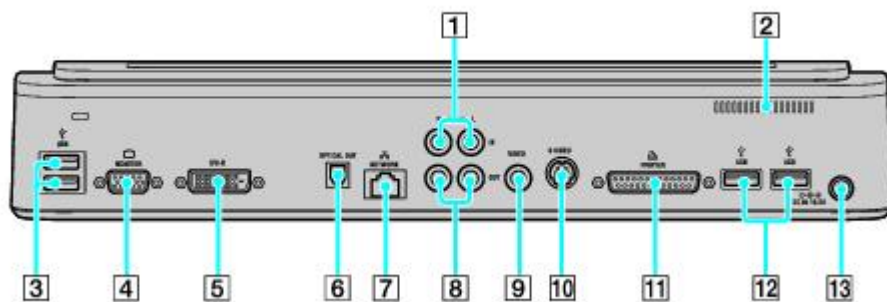

1 Composite Audio In jacks **8** Composite Audio Out jacks

2 Air vent **9** Composite Video Out jack

3  USB 2.0 ports¹ **10** S Video Out port

4 Monitor (VGA) port **11** Printer port

5 DVI-D port **12**  USB 2.0 ports¹

6 Optical Out port
Output frequency (48 kHz²/44 kHz) **13** DC IN port

7 Network (Ethernet) port (10BASE-T / 100BASE-TX / 1000BASE-TX³)

¹ Supports high-/full-/low- speeds.

² Output frequency is 48 kHz for all frequencies except 32 kHz and 44.1 kHz.

³ Only selected models support a 1000BASE-TX connection.

Connecting the Port Replicator

Locating Ports and Jacks

A port replicator is a device that attaches to your computer and contains additional jacks and ports, such as USB ports. A port replicator may come with your computer, depending on the model you purchased. If you wish to purchase a port replicator, shop Sony online at <http://www.sonymstyle.com/vaio> or contact your local retailer.

 The printer port on this port replicator is intended for printer connections only.

A/V Port Replicator

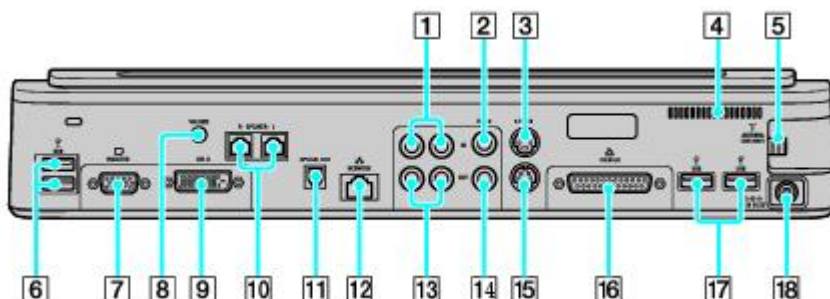

1 Composite Audio In jacks **10** Speaker jacks (right and left)

2 Composite Video In jack **11** Optical Out port
Output frequency (48 kHz¹/44 kHz)

3 S Video In port **12** Network (Ethernet) port (10BASE-T / 100BASE-TX / 1000BASE-TX²)

4 Air vent **13** Composite Audio Out jacks

5 VHF/UHF port **14** Composite Video Out jack

6  USB 2.0 ports³ **15** S Video Out port

7 Monitor (VGA) port **16** Printer port

8 Volume jack **17**  USB 2.0 ports³

9 DVI-D port **18** DC IN port

¹ Output frequency is 48 kHz for all frequencies except 32 kHz and 44.1 kHz.

² Only selected models support a 1000BASE-TX connection.

³ Supports high-/full-/low- speeds.

 The printer port on this port replicator is intended for printer connections only.

Business Port Replicator

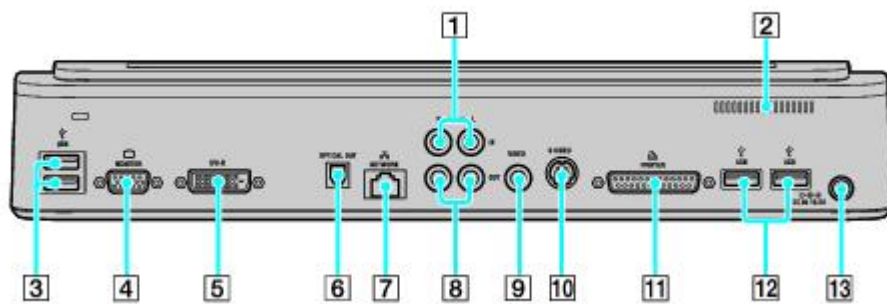

1 Composite Audio In jacks **8** Composite Audio Out jacks

2 Air vent **9** Composite Video Out jack

3  USB 2.0 ports¹ **10** S Video Out port

4 Monitor (VGA) port **11** Printer port

5 DVI-D port **12**  USB 2.0 ports¹

6 Optical Out port
Output frequency (48 kHz²/44 kHz) **13** DC IN port

7 Network (Ethernet) port (10BASE-T / 100BASE-TX / 1000BASE-TX³)

¹ Supports high-/full-/low- speeds.

² Output frequency is 48 kHz for all frequencies except 32 kHz and 44.1 kHz.

³ Only selected models support a 1000BASE-TX connection.

Connecting a Port Replicator

Connect a port replicator to the computer while the computer is off. Use the AC adapter (not the battery) to power the computer while it is connected to a port replicator.

 Moving the computer with the port replicator attached could disconnect the AC adapter or power cord, and may cause the computer to lose power or malfunction.

To connect a port replicator

1. Turn off the computer, and disconnect all attached devices.
2. On the bottom of the computer, slide the port replicator cover down until the port replicator connector is completely visible.

Sliding the Port Replicator Cover

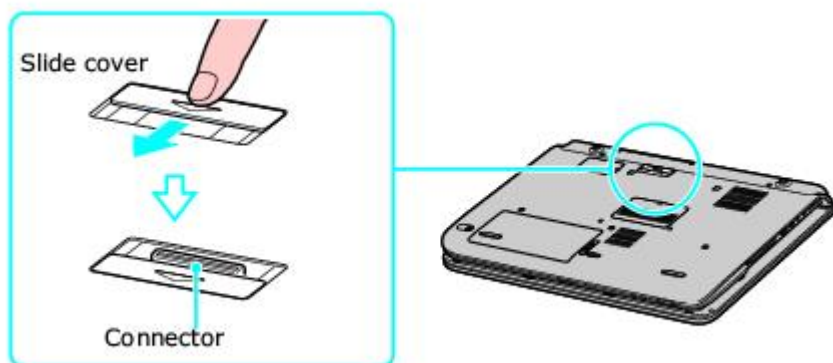

3. Align the connector on the bottom of the computer with the latch and the port replicator connector.
4. Gently push the computer down until it clicks into place.

Connecting the Port Replicator

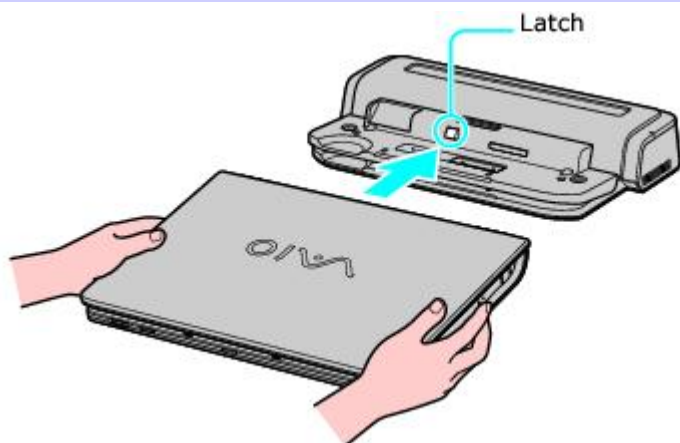

5. Make sure the port replicator is securely fastened to the computer.

Securing the Port Replicator

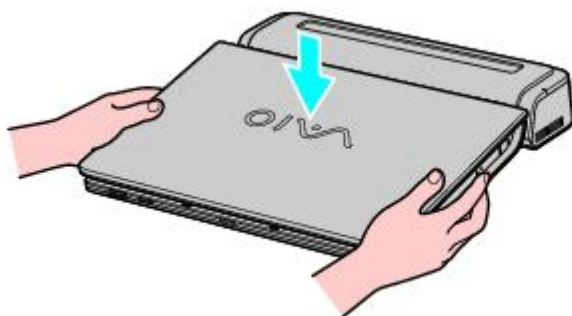

6. Slide the **LOCK/UNLOCK** switch located on the port replicator to **LOCK**.

Locking the Port Replicator

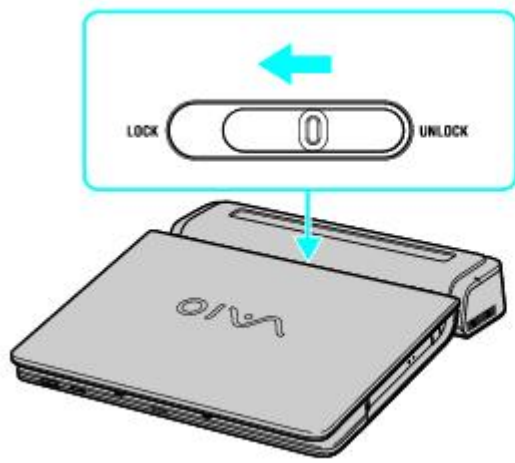

7. Plug the AC adapter into the **DC IN** port on the port replicator, and plug the power cord into the AC adapter and an AC outlet. The power indicator turns on.

Connecting the AC Adapter to the Port Replicator

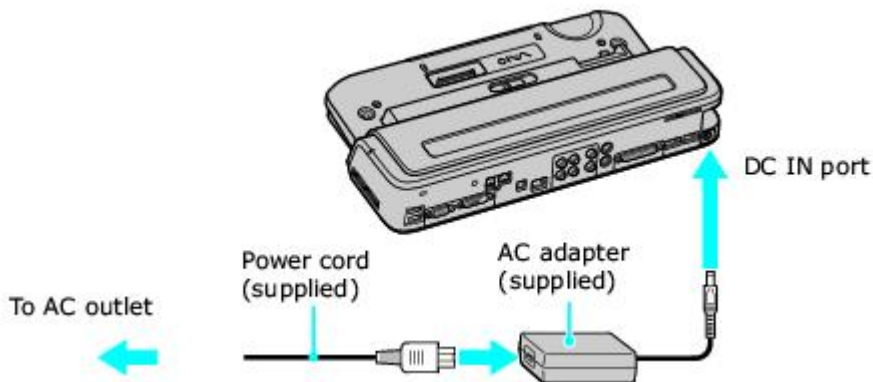

 You can charge the battery by installing it before you connect the port replicator. The battery automatically charges once you connect the AC adapter.

8. Turn on the computer.

Disconnecting the Port Replicator

To disconnect the port replicator

1. Close any active programs to prevent data loss.
2. Turn off the computer and disconnect the power cord.
3. Slide the **LOCK/UNLOCK** switch to **UNLOCK**.
4. Lift the computer away from the port replicator.

Disconnecting a Port Replicator

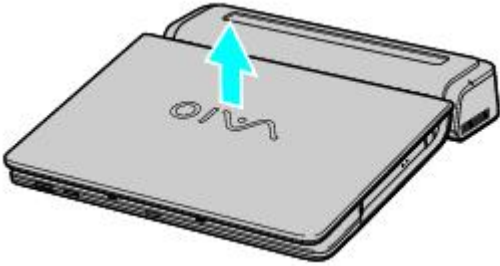

Giga Pocket Personal Video Recorder

Giga Pocket® Personal Video Recorder is a suite of interactive Sony audio and video components that are designed to create, capture, and play back video files derived from television and your personal videos.¹

 Giga Pocket Personal Video Recorder is available only on computers that come with an A/V port replicator. The A/V port replicator must be attached to the computer at all times when using Giga Pocket Personal Video Recorder.

¹ Unauthorized duplication of audio or video files is a violation of applicable laws.

Introducing Giga Pocket Personal Video Recorder

Giga Pocket® Personal Video Recorder is a unique set of tools that enhance your VAIO® computer's capabilities. Giga Pocket software gives you a wide range of video viewing, recording, and playback capabilities, such as:

- Watching and recording television programs from your computer.
- Viewing and recording TV programming simultaneously.
- Setting and managing daily/weekly timer recording schedules.
- Managing Video Capsules (recorded video contents) on your computer.
- Recording personal video content from a videotape.
- Playing your Video Capsules on other computers.
- Operating Giga Pocket functions with a remote control device.
- Sharing Giga Pocket features and functions with other computers on a network.
- Transforming Video Capsules into gMovie™ format for viewing on your CLIE® handheld.

 For an explanation of Giga Pocket terms, see the [Glossary](#).

Giga Pocket Personal Video Recorder includes:

- **Giga Pocket**—This application enables you to watch TV programs on your computer's display and record them onto the hard disk drive as Video Capsules for later playback.
- **Timer Recording Manager**—The Timer Recording Manager keeps track of all TV program recordings you have scheduled. This program also enables you to modify timer recordings.
- **Timer Recording Wizard**—The Wizard interface guides you through setting up a timer recording schedule. You can program one-time recordings and set up daily or weekly recurring recording schedules.
- **Giga Pocket Explorer**—The Giga Pocket Explorer program functions as your video file management system, and stores recorded Video Capsules as well as modified Playlists. Giga Pocket Explorer contains export/import functions for file format conversions.
- **Giga Pocket Server**—The Giga Pocket Server enables multiple computers on a network to use certain Giga Pocket software functions.
- **CLIE Converter**—The CLIE Converter is a plug-in application that enables the conversion of Video Capsules into gMovie format. You can change the format your Giga Pocket® contents and transfer them onto a Memory Stick® media for viewing with your Sony CLIE handheld.

Accessing the Giga Pocket Help

For more information about Giga Pocket Personal Video Recorder, follow these steps:

1. Click **Start** in the Windows® taskbar and select **All Programs**.
2. Select **Giga Pocket, Help**, and click **Giga Pocket Help**.

 **Giga Pocket Personal Video Recorder maintains information about the software and Video Capsules on your computer's drive D, in a folder named D:\Giga Pocket V5. This folder and its contents are not designed for your direct maintenance. Please do not move, modify or delete the Giga Pocket Folder or any of its contents. Any alteration to this folder or its contents may cause your Giga Pocket software and Video Capsules to stop working properly.**

About Giga Pocket Personal Video Recorder

The information in this section provides guidelines to follow when using Giga Pocket® Personal Video Recorder.

Display setup

Always set up your display as follows when you use Giga Pocket software:

- Color quality: Use factory default settings (32-bit).
- Screen resolution: Use the factory preset screen resolution setting. Using other display settings may cause an improper screen image or an incorrect recording by Giga Pocket software.
- Check your display setup in the Microsoft® Windows® operating system before starting up Giga Pocket software. For more information, refer to the operating system manual.
- Do not change the display setup while Giga Pocket software is running, or your system may operate improperly.

Hard disk drive

- When the available free space on your hard disk approaches 100 MB, you are not able to create a new Video Capsule. Delete unnecessary Video Capsules or files in order to increase available space on your hard disk drive.
- If you directly delete, move, or rename a file in the D:\Giga Pocket V5 folder, Giga Pocket Personal Video Recorder features may not work properly.

Network

- Microsoft® Windows® XP operating system supports a single Giga Pocket user at any given time. Even if a different user logs on using the Fast User Switching feature, Giga Pocket software is not available to any other user account. For more information, see the Giga Pocket Help.
- Microsoft Windows XP operating system supports a single Giga Pocket user at any given time. If a different user logs on using the fast switch feature, the Timer Recording feature is not available to another user account. The Timer Recording Manager icon appears in the task tray of the 1st user to log on.

Glossary

The most common terms for Giga Pocket Personal Video Recorder software are defined below.

Cabinet A cabinet acts as a container for Video Capsules in Giga Pocket Explorer. A network cabinet is located on other computers in a network environment.

CATV Refers to Community Access Television, otherwise known as cable television.

Clip A clip is a movie or image that serves as video content material.

Expiration date A Video Capsule is stored on the hard disk drive for a preset period of time. When this time has expired, the Video Capsule is automatically deleted.

Film roll During Video Capsule playback, a snapshot view of the scenes are captured on a film roll. You can scroll freely through the film roll to view different scenes.

HotSync® Registered trademark of PalmSource, Inc. for the method of linking between a handheld device and a larger computer, such as a desktop or notebook computer.

Management information Management information contains the creation date of Video Capsules and their thumbnails. This information is required for preview.

MPEG file extension. A file that contains compressed moving pictures using the MPEG standard, with .mpg as the file name extension.

Safety Tab Removing the safety tab from a Video Capsule prevents accidental erasing of your video data.

Slip play This feature allows you to view delayed video playback. While your recording is in progress, you are able to view the recording from the beginning.

Snapshot A snapshot is a miniature view displayed on the film roll in Giga Pocket® software and the preview monitor in Giga Pocket Explorer.

Stand by mode Stand by mode is a power saving mode that is set up by using the Windows® operating system. Your computer stays in this power saving mode until approximately 5 minutes before the timer recording is due to begin.

STB Refers to set-top box, also known as a cable or satellite box.

Thumbnail A thumbnail is a miniature view on recorded Video Capsules or in playback by Giga Pocket software. The main thumbnail is displayed in calendar view or in the Giga Pocket Explorer list area.

Timer recording A timer recording is a preset video recording event.

Video Capsule A Video Capsule is a virtual container that holds the video images recorded with Giga Pocket Recorder. A Video Capsule is created on your computer hard disk drive and managed with Giga Pocket Explorer.

Accessing Giga Pocket Help

For more information about Giga Pocket, follow these steps:

1. Click **Start** in the Windows taskbar and point to **All Programs**.
2. Point to **Giga Pocket**, point to **Help**, and then select **Giga Pocket Help**.

Setting Up Giga Pocket Personal Video Recorder

This section illustrates how to set up the cables and connections for your Giga Pocket® Personal Video Recorder system.

 The hardware configuration of your computer may vary from the illustrations shown. To view the specific hardware configuration for your computer, see the online specifications sheet.

Before you begin setting up the cables and connections, you must attach the A/V port replicator to your computer. See [Connecting the Port Replicator](#) for instructions. The A/V port replicator must be attached to the computer at all times when using Giga Pocket Personal Video Recorder.

To set up TV connections

The best method of connecting your computer system, TV monitor or display, and cable service access, depends on the type of cable connection available in your home.

TV signal reception strength will vary widely depending on service availability in your area as well as the type of connection available.

 The A/V port replicator is supplied with certain audio and video cables. Depending on your in-home cable access, you may require extra cables, adapters or connection equipment not supplied with your computer.

The TV coaxial converter cable

One primary cable to connect your computer to a TV cable or antenna is the TV coaxial converter cable (supplied with the A/V port replicator). The mini-jack end connects to the computer's VHF/UHF port, and the coaxial end connects to the cable service access or antenna

TV coaxial converter cable



Connecting to standard cable access (CATV)

Option 1

1. Connect one end of the coaxial converter cable (supplied) to your cable service access.
2. Connect the other end of the coaxial converter cable to the VHF/UHF port on the A/V port replicator.

To connect in CATV mode (Option 1)

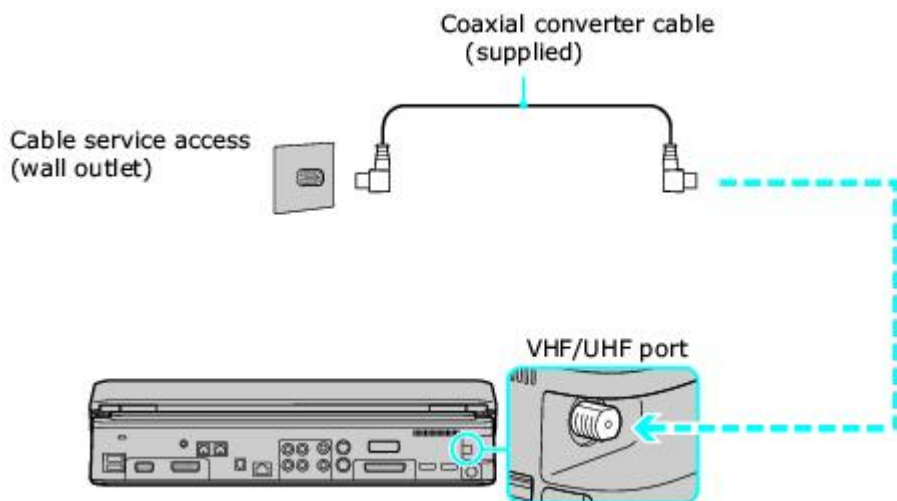

Option 2

1. Connect the two metal hooks on the RCA transformer cable (optional) to your cable service access.
2. Connect the TV coaxial converter cable (supplied) from the transformer end of the RCA transformer cable to the VHF/UHF port on the port replicator.

To connect in CATV mode (Option 2)

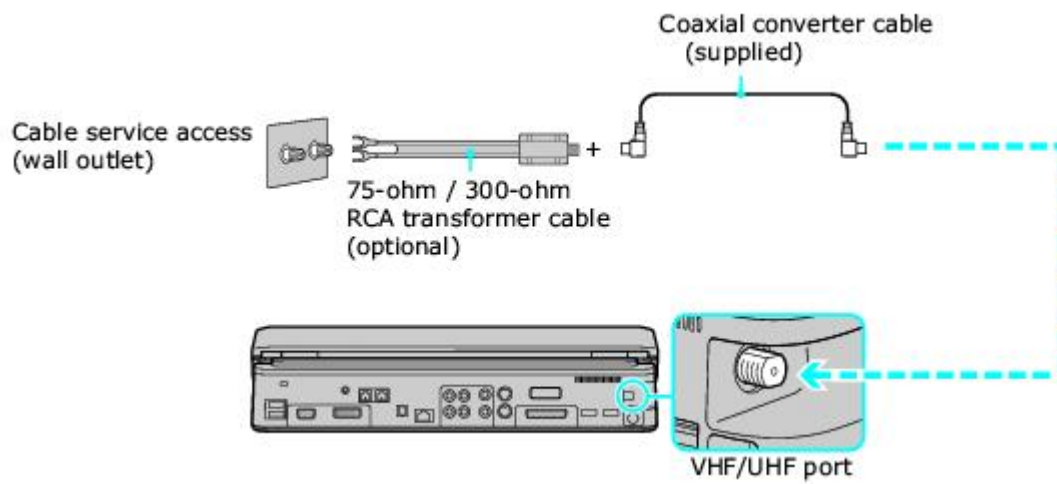

Connecting to a standard antenna

You can connect your Giga Pocket system to an indoor/outdoor antenna system, using Option 1 or Option 2 from the previous section, [Connecting to standard cable access \(CATV\)](#). Depending on the type of antenna system in your home, your connection may require a VHF/UHF RF combiner/transformer (optional) to connect your computer and the indoor/outdoor antenna system.

 If you are connecting to an indoor/outdoor antenna, you may need to reorient the antenna for best reception. Move the antenna cable away from other power sources or connectors to reduce reception interference.

Option 1

1. Connect one end of a TV coaxial cable (optional) to your antenna outlet. Connect the other end to a VHF/UHF RF combiner/transformer (optional).
2. Connect the coaxial cable feed connector (optional) to the VHF/UHF combiner/transformer.
3. Connect the TV coaxial converter cable (supplied) from the feed connector to the VHF/UHF port on the port replicator.

Option 2

1. Connect both ends of the antenna's twin lead cable to the screw-type grips on the combiner/transformer.
2. Connect the coaxial cable feed connector (optional) to the VHF/UHF combiner/transformer.
3. Connect the TV coaxial converter cable (supplied) from the feed connector to the VHF/UHF port on the port replicator.

To connect in standard antenna mode (air)

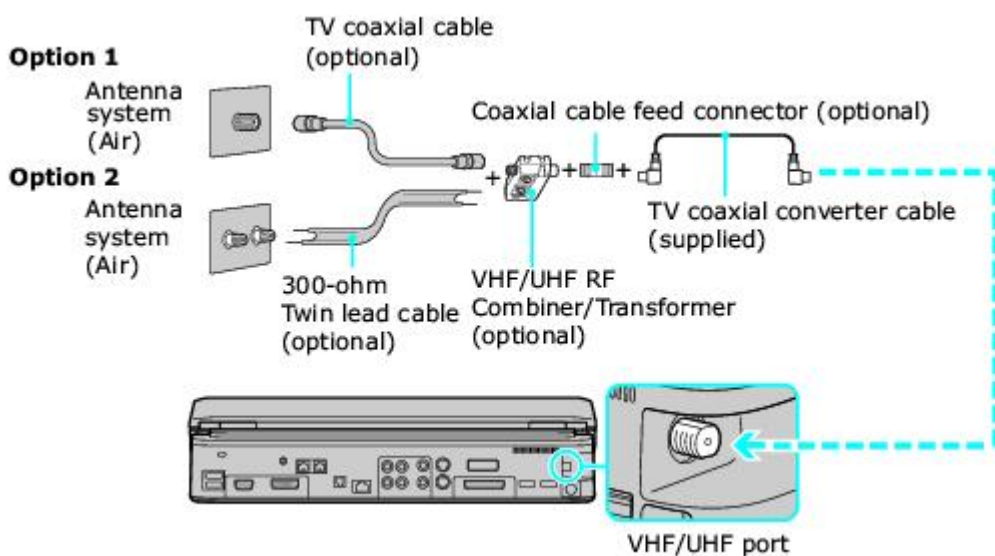

 Your VAIO® computer is supplied with certain audio and video cables. Depending on your in-home cable access, you may require extra cables, adapters or connection equipment not supplied with your computer.

Connecting with a cable or satellite set-top box (STB)

You can connect your Giga Pocket® system to cable service access that uses a set-top box (cable or satellite). When using the set-top box (STB) setup, you can only change channels through the STB, using its controls or supplied remote control.

When using the STB setup:

- The Giga Pocket remote control cannot be used to change TV channels. You can use the Giga Pocket remote control to set Giga Pocket software to the appropriate channel-out number (channel 3, 4, etc.) or to the direct video input specified by your cable or satellite service provider.
- A standard TV remote control cannot be used to change TV channels. You can use your TV remote control to set the TV to the channel-out number (channel 3, 4, etc.) or direct video input specified by your cable or satellite service provider.
- You may be able to use a universal remote control or commander to change TV channels, if the device is able to control the STB.

 Cable/satellite service, equipment, and features, may vary between service providers. Contact your cable or satellite service provider for details on using STB equipment and accessories.

Option 1

1. Connect one end of a TV coaxial cable (optional) to your cable service access. Connect the other end to the In jack on the back panel of your set-top box (STB).
2. Connect a second TV coaxial cable (optional) to the Out jack on your STB. Connect the other end to the single-connection end of a splitter device (optional).
3. Connect a third TV coaxial cable (supplied) to the double-connection end of the splitter device. Connect the other end to the VHF/UHF port on the port replicator.
4. Connect a fourth TV coaxial cable (optional) to the double-connection end of the splitter device. Connect the other end to the VHF/UHF port on the rear of your TV monitor or display.

To connect in STB mode (Option 1)

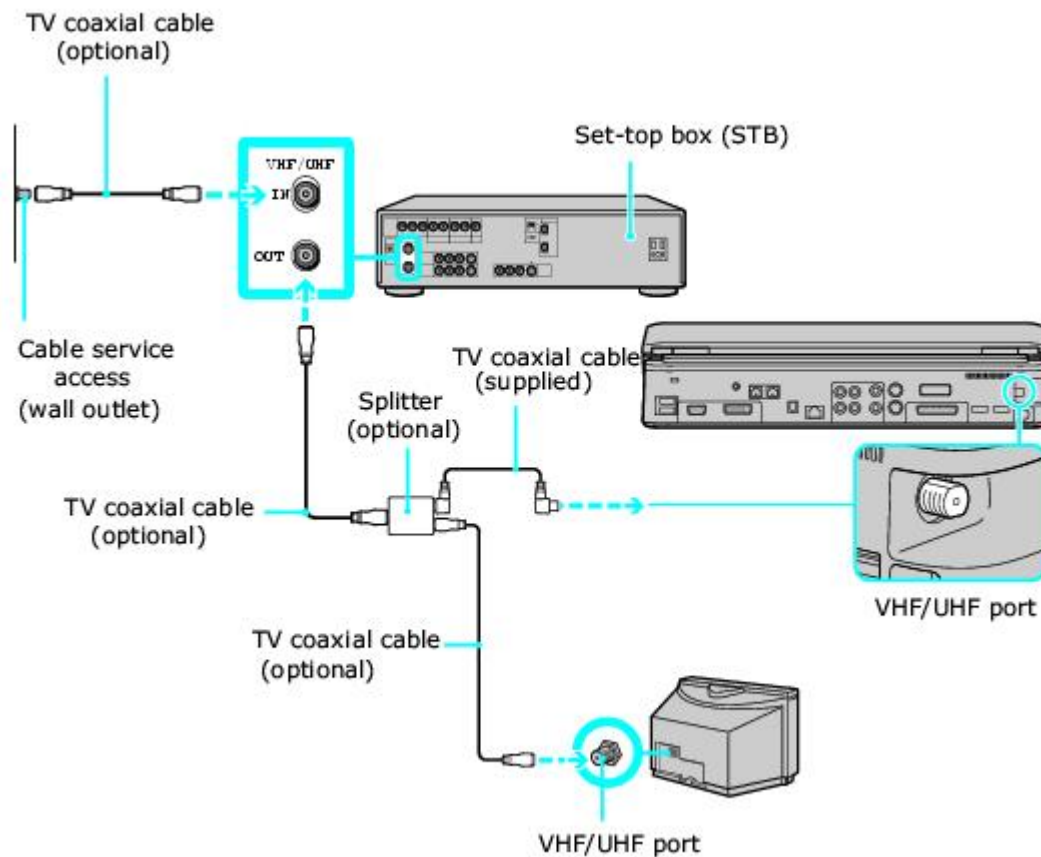

Option 2

1. Connect one end of the TV coaxial cable (supplied) to your cable service access. Connect the other end to the In jack on the back panel of your set-top box (STB).

2. Connect a second TV coaxial cable (optional) to the Out jack on your STB unit. Connect the other end to the VHF/UHF port on the rear of your TV monitor or display.
3. Connect one end of a stereo A/V dubbing cable with triple RCA jacks (optional), to the Video Out and Audio-OUT (L/R) jacks on the back panel of your STB unit, matching the plug and jack colors.
4. Connect the other RCA jacks of the stereo A/V dubbing cable into the Composite Audio-R (IN), Composite Audio-L (IN), and Composite Video (IN) jacks on the port replicator, matching the plug and jack colors.

To connect in STB mode (Option 2)

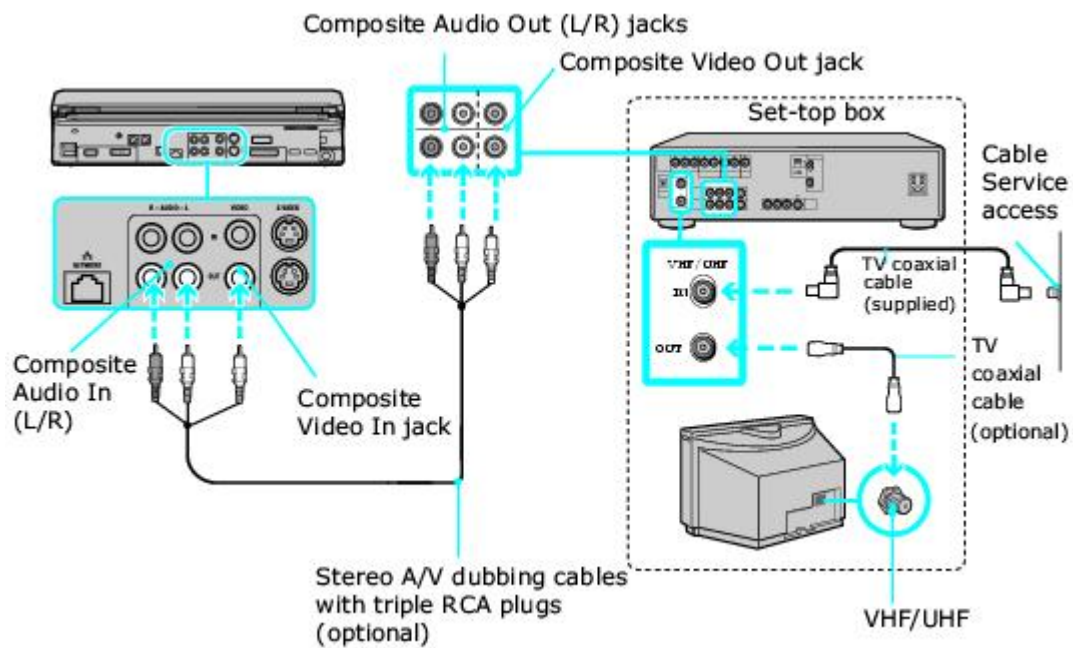

Setting up additional equipment

This section illustrates how to set up additional equipment with the Giga Pocket® Personal Video Recorder System.

To connect a compatible VCR or camcorder

Your VAIO® computer has both audio and video connection capability. You can locate the connections on the port replicator. You can connect a VCR or camcorder, using the audio jacks and video ports. Your VCR or camcorder may have either standard video or S Video connection capability.

To connect with an S Video cable

1. Connect an S Video cable (optional) directly into the S Video jack on the port replicator.
2. Connect the other end of the S Video cable into the appropriate port on your compatible VCR or camcorder.

To connect with an audio cable (Dual RCA plugs)

1. Connect an audio cable with double RCA plugs at each end (optional) into the composite audio L and R jacks, located on the port replicator.
2. Connect the other ends of the audio cable into the appropriate ports on your compatible VCR or camcorder.

To connect with a stereo A/V dubbing cable (Triple RCA plugs)

1. Connect a stereo A/V dubbing cable with triple RCA plugs at each end (optional) directly into the composite video In port, composite audio L and R In jacks, located on the port replicator.
2. Connect the other ends of the stereo A/V dubbing cable into the appropriate jacks on your compatible VCR or camcorder.

Connecting the Giga Pocket Remote Control

Your A/V port replicator comes with a remote control and speakers, which have a built-in infrared (IR) remote control receiver. The speakers must be plugged into one of the computer's USB ports in order to receive the signals from the remote control.

About the Remote Control

Giga Pocket® Personal Video Recorder features are controlled with the remote control. The remote control can start and stop video recording and playback, select channels, and set viewing preferences. This section describes the basic functions of your remote control.

Remote Control

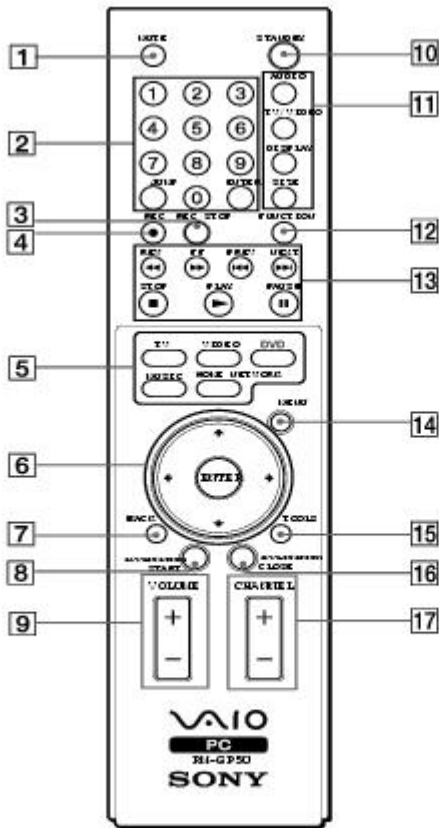

1 MUTE button

Press to turn off the sound. Press again to restore the sound.

2 Channel number buttons (0-9)

Press to select specific channels.

(Press the **ENTER** button to activate channel selection.)

JUMP button

Press to go to the previous channel. Press again to return to the current channel.

ENTER button

Press to activate channel selection. See **Channel number** buttons.

3 REC STOP button

Press to stop recording.

(Note: The **REC STOP** function is available for Giga Pocket software only.)

4 REC button

Press to begin recording.

(Note: The **REC** function is available for Giga Pocket software only.)

5 TV button

Press to change from the on-screen image to the TV/Recording deck.

VIDEO button

Press to start the Giga Pocket playback deck.

(Note: You cannot change the input source while recording.)

DVD button

Press to start the DVD player software program.

MUSIC button

Press to launch the SonicStage software.

HOME NETWORK button

Press to launch the VAIO Media software.

6 Direction and ENTER buttons

Press a direction arrow to navigate. Press **ENTER** to select.

7 BACK button

Press to return to the previous screen.

(Note: This function is not available for Giga Pocket software.)

8 APPLICATION START button

Press to open a shortcut menu of software programs to start. Use the direction arrows to navigate to a specific software program and press the **APPLICATION START** button to select and start the program.

9 VOLUME button

Press to raise or lower the volume.

10 STANDBY button

Press to place the system into Stand by mode.

(Note: You cannot place the computer into Stand by mode when certain Giga Pocket functions are running.)

11 AUDIO button

Press to view available sound mode options on the monitor/display.

TV/VIDEO button

Press to change the on-screen image from the TV/Recording deck to external video equipment, such as your VCR.

(Note: You cannot change the input source while recording.)

DISPLAY button

During DVD playback in full screen mode, press to show the settings window. When using Giga Pocket software, press to display the TV/Recording deck and playback deck screens. Press again to hide these views.

SIZE button

Press to view the current software in full-screen size. Press again to return the view to its original size.

12 FUNCTION button

When using SonicStage software, press to change from the music drive (hard disk drive) to the CD.

13 REW and FF buttons

Press to rewind or fast-forward.

PREV and NEXT buttons

Press to move back to the previous screen or forward to the next screen.

STOP button

Press to stop playback.

PLAY button

Press to begin playback.

PAUSE button

Press to pause playback.

14 MENU button

Press to view a shortcut menu of available options for a software program. Press again to hide this menu.

(Note: For the Giga Pocket software program, the **Select A Cabinet** window displays. Press the button again to hide this window.)

15 TOOLS button

The function of this button may vary between DVD media. See the DVD player software instructions for details.

16 APPLICATION CLOSE button

Press to view a shortcut menu of software programs to close. If more than one software program is open, use the direction arrows to navigate to a specific program and press the **Application Close button again to close the program.**

17 CHANNEL button

Press to change channels automatically (no number input required).

(Note: This function is available for Giga Pocket software only.)

¹This function is available on selected models.

 For more details about the function buttons on your remote control, see the Giga Pocket software program Help.

To set up the remote control

Insert two AA batteries (supplied) into the remote control as shown.

Inserting batteries into the remote control

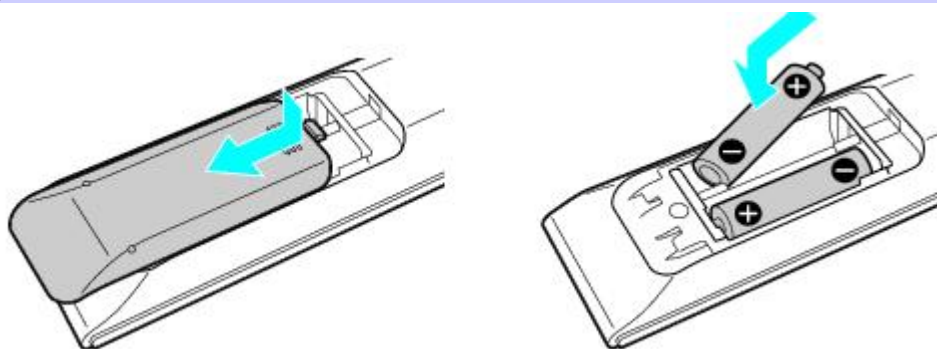

 Under normal use, the AA batteries may last up to six months. If your remote control does not operate properly, the batteries may need to be replaced.

If your remote control is not being used for extended periods of time, remove the batteries to avoid possible damage from battery leakage.

Connecting the speakers with built-in infrared receiver

1. Connect the mini-jack end of the audio cable, which is attached to the right speaker, to the Volume jack on the port replicator.
2. Connect the USB cable, which is attached to the left speaker, to one of the USB connectors on the port replicator.
3. Connect the two audio cables with jack connectors to the Speaker Right and Left jacks on the port replicator. Make sure the connectors are properly inserted into the jacks.

 Sound may be muted or extremely loud if the connectors are not properly inserted.

4. Place the speakers in a position that enables it to communicate with your remote control.

Connecting the Speakers

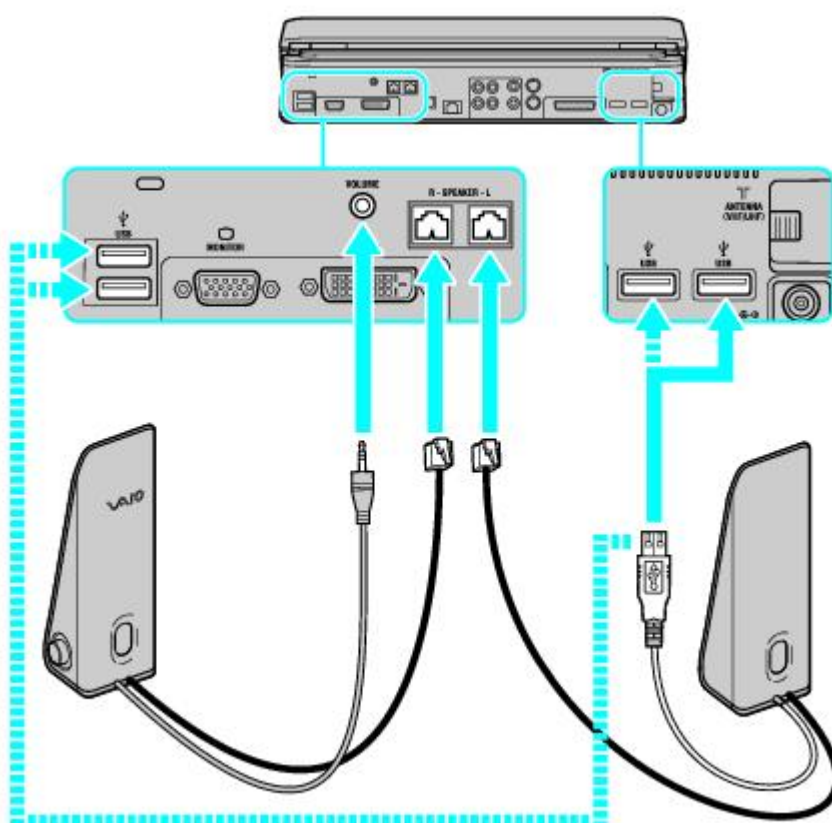

 The infrared receiver must be visible in a line-of-sight with your remote control in order to function properly.

Setting Up Giga Pocket Software

Giga Pocket® Personal Video Recorder software features and functions are detailed in this section, enabling you to begin viewing or recording TV programs.

To set up TV viewing

When you start Giga Pocket Personal Video Recorder for the first time, you are automatically prompted to set the video input source for watching TV or cable TV (CATV) programs on your computer.

Setting Up Giga Pocket Software

Giga Pocket® Personal Video Recorder software features and functions are detailed in this section, enabling you to begin viewing or recording TV programs.

To set up TV viewing

When you start Giga Pocket Personal Video Recorder for the first time, you are automatically prompted to set the video input source for watching TV or cable TV (CATV) programs on your computer.

Starting Giga Pocket software for TV Setup (For first time setup)

1. Verify that the computer time and date settings as displayed in the taskbar are correct.

To adjust these settings:

1. Right-click on the time clock shown in the taskbar notification area. A shortcut menu appears.
 2. Select **Adjust Date/Time**, and a dialog box appears.
 3. Correct the date and time, if necessary, and then click **Apply**.
 4. Click **OK** to close the dialog box.
2. Click **Start** in the Windows taskbar, point to **All Programs**, point to **Giga Pocket**, point to **All Software**, and then click **TV Setup**.

The **TV Setup Wizard** appears.

TV Setup Wizard

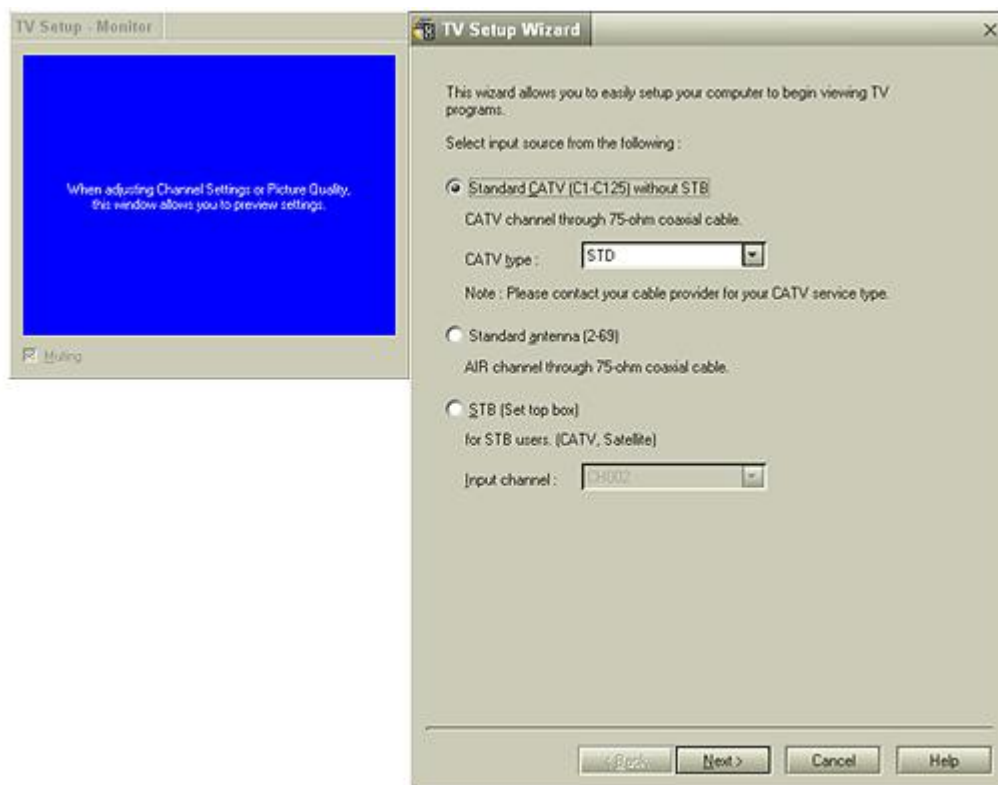



3. Depending on your cable service access, select **Standard CATV**, **Standard antenna**, or **set-top box (STB)**.
 1. **Standard CATV (C1-C125) without STB** — For this connection, you must use a coaxial cable directly (without an STB) to your computer. The default setting for this connection option is STD. Depending on your local connection requirements, HRC and IRC are also available.
 2. **Standard antenna (2-69)** — Select this option if you connect an aerial antenna's coaxial cable directly to your computer for watching TV programs.
 3. **STB (Set top box)** — Select this option if the broadcast signal is received from a set top box (STB) such as a digital cable or satellite box. Make sure that the Input channel on your STB (Ch. 3, Ch. 4, etc.) matches the Input channel listed in the Giga Pocket TV Setup dialog box.

 If you are not sure of the type of cable connection to use (Standard, HRC, or IRC), contact your cable provider for information.

4. Click **Next**. The wizard displays a dialog box that enables you to customize the channel listings.
5. Click **Auto Scan**.

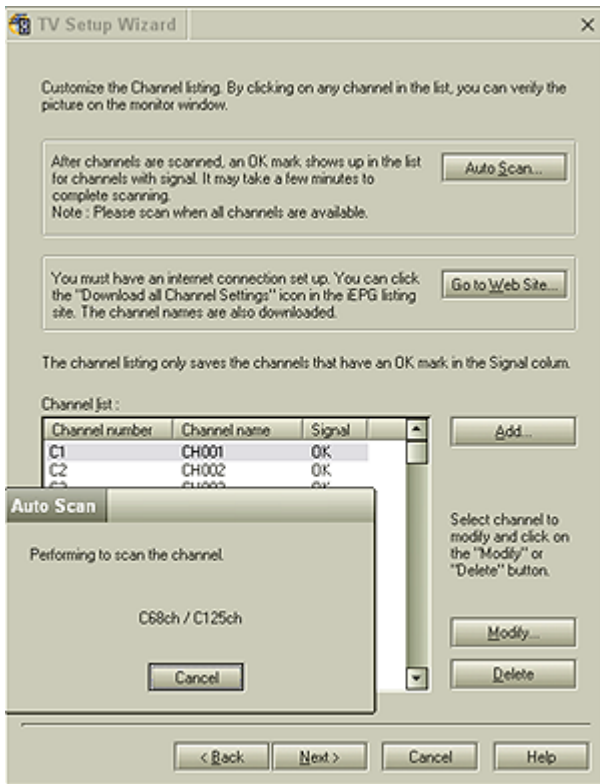
You can view the channel reception in the pop-up **TV Setup - Monitor** window.



 If your computer is connected to the Internet, you can click **Go to Web site...** and download channel listings from the iEPG listing site.

6. Connect to the Internet.
7. Click **Go to Web site...** and download channel listings by clicking **Download all Channel Settings**.
8. Click **Next**. For the first time setup, you are prompted to set your Giga Pocket Server password.

TV Setup Wizard - Giga Pocket Server password

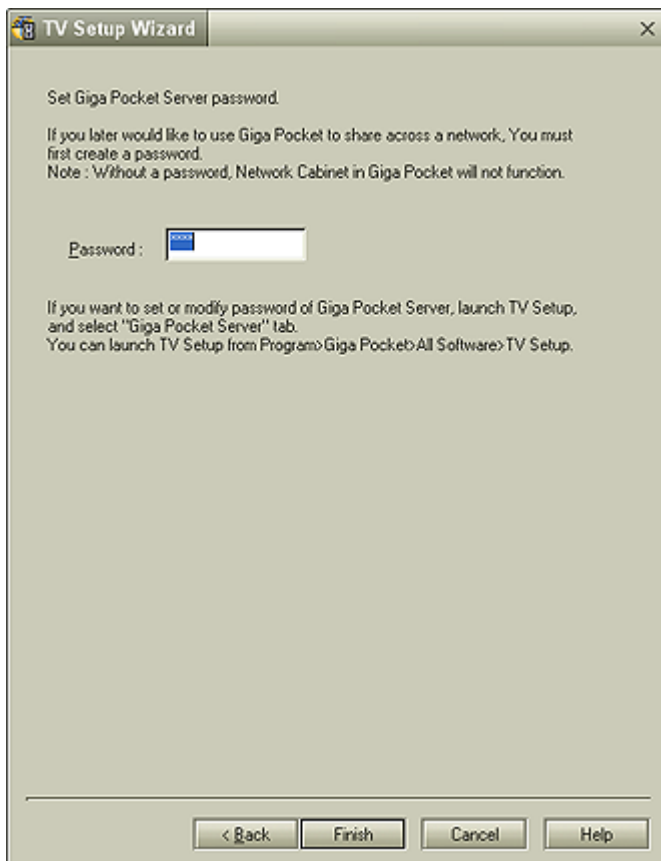

9. Type in a password and click **Finish**.

Setting up your display (monitor)

When using Giga Pocket® Personal Video Recorder, set your display settings as follows:

- **Colors** — Use the default factory settings (32-bit).
- **Screen area** — Use the default video resolution.

If you change the default settings, you may experience poor image quality on your display.

 Microsoft® Windows® XP operating system supports a single Giga Pocket software user at any given time. Even if a different user logs on using the fast switch feature, Giga Pocket software is not available to any other user account. For more information, see Giga Pocket Help.

Giga Pocket

Giga Pocket® software enables you to watch a TV program on your computer display while recording it onto your hard disk drive. Using the Giga Pocket Slip Play feature, you can view a program from the beginning even while it is being recorded.

Starting Giga Pocket Software

1. Click **Start** in the Windows® taskbar, point to **All Programs**, point to **Giga Pocket**, then click **Giga Pocket**. The **Giga Pocket** window appears.

Giga Pocket window



 The current television broadcast is displayed, based on the selected channel.

Using the TV/Recording deck and Playback deck

Giga Pocket® features two decks on the main interface window: the TV/Recording deck and the Playback deck.

TV/Recording deck (detail)

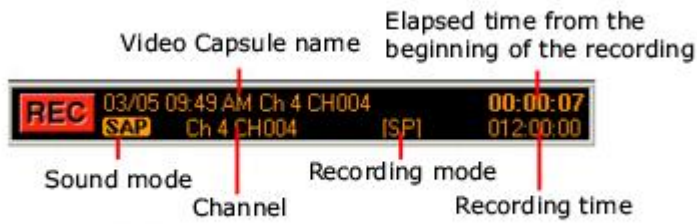

Use the TV/Recording deck to view programs and record Video Capsules. You can use the Playback deck of your Giga Pocket software to play back a prerecorded Video Capsule.

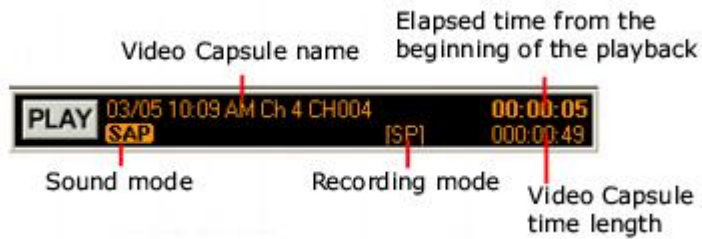

Playback deck (detail)



Recording a Video Capsule

Giga Pocket software stores recorded images as Video Capsules. The Video Capsules provide file recording information, which can be viewed through Giga Pocket Explorer. Manage your Video Capsules with Giga Pocket Explorer.

 You cannot record a program into a previously recorded Video Capsule. All new content is recorded into a new Video Capsule.

1. Select your program by switching to the appropriate channel. Use the channel buttons located at the bottom of the Giga Pocket window, or use the right and left direction arrows on your keyboard.
2. Click **Record** , located at the bottom of the window, to begin recording your Video Capsule.
3. When your program has completed or you wish to end the Video Capsule, click **Stop** .

 To pause your recording session, click **Pause** . Click on it again to resume recording.

Using the Slip Play feature

While a program is being recorded on the TV/Recording deck, you can watch that same program from the beginning, using the Playback deck. You can begin using Slip Play to view your recording, beginning approximately ten seconds after your recording session begins.

1. From the menu bar, click **Functions**.
2. Select **Start Slip Play**.

Additional information about Giga Pocket software

- Giga Pocket® software can be used for external video recording. Depending on conditions, not all video images can be recorded or displayed.
- Video input from game consoles may not be recorded or displayed in Giga Pocket software.
- When you input an image from a video player device, such as a VCR that is connected to your computer, the following images may not record or display:
 - The still images of a paused playback screen.
 - A screen without images, such as a blue screen.
 - The menu screens of the attached video player device.
- The Giga Pocket software's displayed image or images from a prerecorded Video Capsule may be interrupted or distorted under the following circumstances:
 - If you change the channel on an attached video player device.
 - If you switch input during the analog input from an attached video player device.
 - If you attempt to play back a damaged video tape.
 - If you press Pause during the recording process.
- When you play a Video Capsule for a few seconds from the end of the film roll using the scroll bar, you may not be able to see a displayed image.
- The computer's response may decrease when you attempt to play a Video Capsule while recording a TV program using Giga Pocket software.

Giga Pocket software may interrupt or stop playback to allocate system resources for the timer recording event, if there are other applications running simultaneously. If this occurs, wait until Giga Pocket software finishes recording before playing the Video Capsule.

- The timer recording may fail due to an "Event buffer of audio overflow" error in the following circumstances:
 - The input cable (coaxial or video cable) is disconnected after recording starts.
 - You record a TV channel that has no broadcast content.
 - You record video content from an old video tape with poor signal quality.
- The on-screen display may shift and split under some circumstances. If this occurs, switch the TV/Recording deck and the playback deck, or switch the channel. The recording proceeds even if the on-screen display shifts.
- Giga Pocket® software does not operate properly if used concurrently with other video applications, such as DVgate Plus or Click to DVD software programs.

Using the TV Program Web site

Click **Start** in the Windows taskbar, point to **All Programs**, point to **Giga Pocket**, and then select **Zap2it**.

You can also go directly to the Web site at <http://www.sony.com/vaioty>.

 Timer recording using the Internet Electronic Program Guide service requires an Internet connection. See the section, [Setting up your Internet Electronic Program Guide service](#), for information on using this service.

Internet Electronic Program Guide (iEPG) Web site

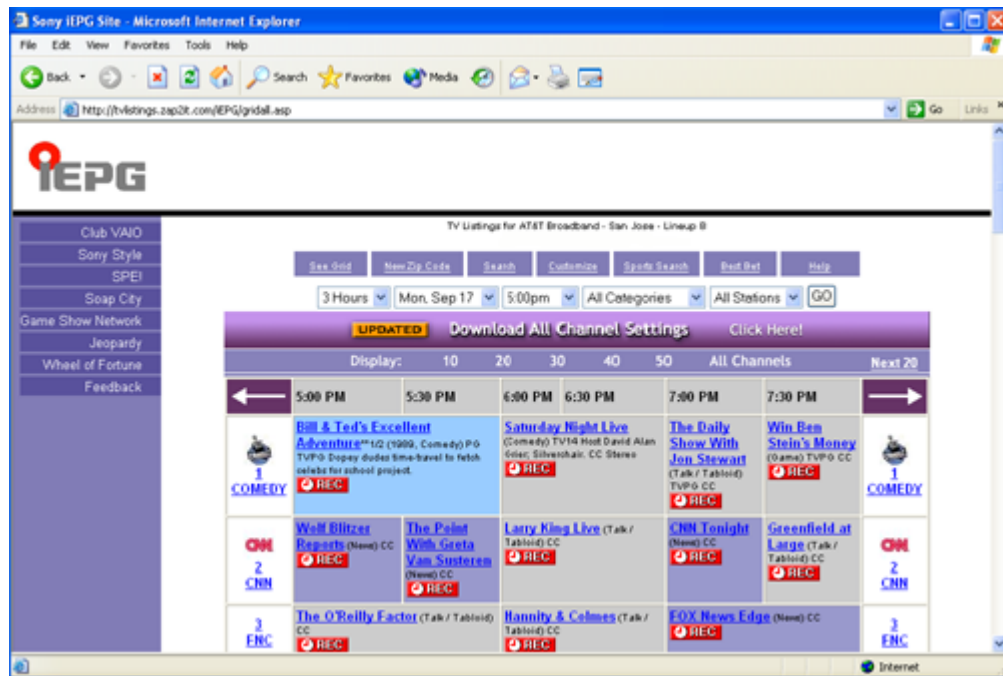

The appearance of the online channel guide Web site, its contents, and the accuracy of the TV listings are controlled by the TV listing provider and may change without notice. Pay-per-view channels can be accessed when making payments directly to the appropriate TV program provider.

You can schedule up to 100 timer recordings using Giga Pocket® Personal Video Recorder.

From the online channel guide, click on the **REC** icon  to select the program you wish to record. The Timer Recording Wizard begins and the **New Timer Recording - Set Channel and Start Date and Time** window appears.

 Timer recordings create virtual containers for the recorded content that are called Video Capsules.

Accessing Giga Pocket Help

For more information about Giga Pocket Personal Video Recorder, follow these steps:

1. Click **Start** in the Windows® taskbar and select **All Programs**.
2. Select **Giga Pocket, Help**, and click **Giga Pocket Help**.

Timer Recording Wizard

With the Timer Recording Wizard, you can set, adjust, and cancel the timer recording settings.

Using the Timer Recording Wizard

1. Click **Start** in the Windows taskbar, select **All Programs**, then select **Giga Pocket**.
2. Select **Timer Recording Wizard**. The **Timer Recording Wizard** dialog box appears.

Timer Recording Wizard



3. Select the desired option from the **Select Timer Recording Settings** menu and click **Next**. Follow the on-screen instructions. Click **Help** if you need more information about selecting timer recording settings.

New Timer Recording - Set Channel, Start Date and Time

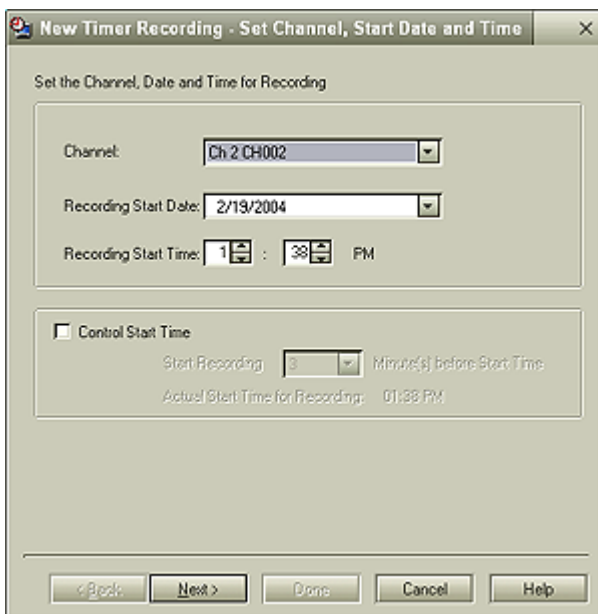

4. Verify that the information is correct and click **Next**. The programming station and time information is automatically programmed into the appropriate Timer Recording Wizard fields.
5. You can set the stop time for your timer recording and select the recording mode. The stop time is automatically programmed into the Timer Recording Wizard. Verify the stop time, choose a recording mode, and then click **Next**.

Recording Mode	Description
----------------	-------------

Standard Play (SP) Standard recording mode (MPEG-2).

High Quality (HQ) Image quality is improved, but recording requires more space on the hard disk drive as compared to using SP or LP recording modes (MPEG-2).

New Timer Recording - Set Stop Time and Recording Mode

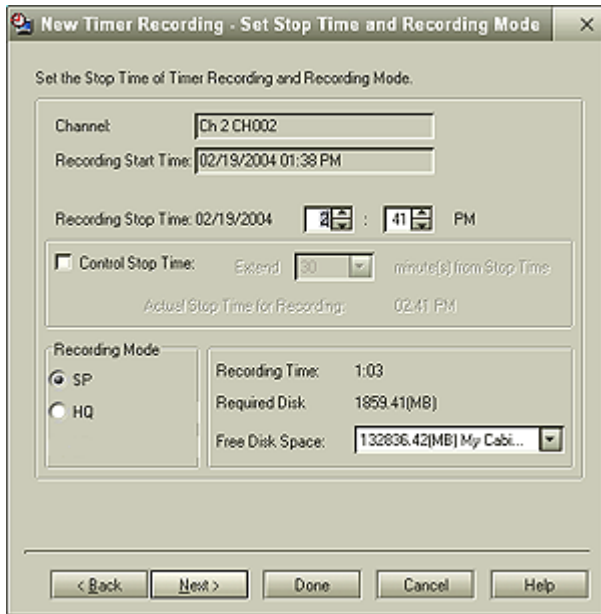

- From the **New Timer Recording - Set Details** dialog box, you can customize the timer recording schedule. Select how often you want to record the program.

New Timer Recording - Set Details

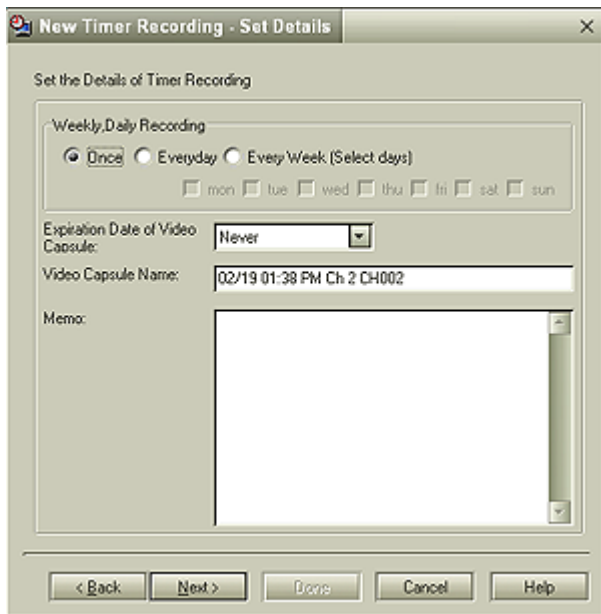

- Select a date for the recorded program to be automatically deleted from your hard disk drive, using the **Expiration date of Video Capsule** drop-down list.

 To maintain adequate space on your hard disk drive, Giga Pocket® Personal Video Recorder enables you to set an expiration date for your Video Capsules to be automatically deleted.

- Click **Done** to review your setting preferences. The **New Timer Recording - Confirm** dialog box appears. Click **Next**.

New Timer Recording - Confirm

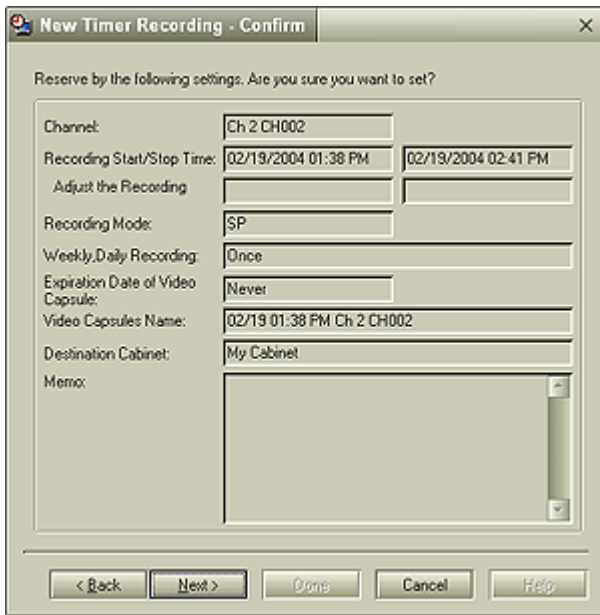

9. The **New Timer Recording - Completed** dialog box appears. Click **Finish**.

New Timer Recording - Completed

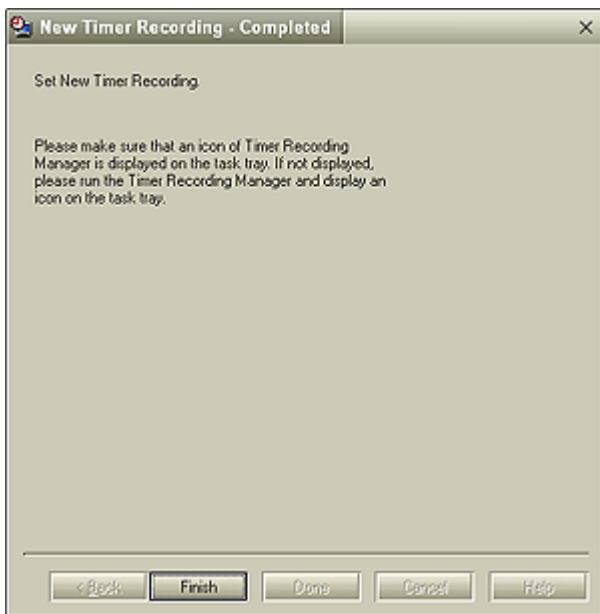

Additional information about the Timer Recording Wizard

- Timer recording requires approximately 30 seconds (pre-recording) preparation time prior to beginning each recording session. Please keep this in mind when setting up multiple, back-to-back recording sessions. Giga Pocket software stops the current timer recording, pauses to prepare, and then begins the next timer recording according to the set start time. The length of your first Video Capsule is approximately 30 seconds shorter than the actual time set.

You may experience some timing problems with multiple recording sessions when the second timer recording is preset as a daily or weekly recorded event. The first timer recording may end as early as 60 seconds sooner than the set stop time.

- Scheduled daily or weekly timer recording sessions do not occur if your hard disk drive does not have sufficient space. Giga Pocket software does not allow a new Video Capsule to be created if there is less than 100 MB of free space on the hard disk drive. These scheduled events resume at their scheduled time, as hard disk drive space becomes available.
- Approximately three minutes before Giga Pocket software begins a timer recording and during a timer recording, you must avoid:
 - Starting up or using other software applications.
 - Setting up, changing, or deleting timer recordings.
 - All activities that may access the hard disk drive, such as copying files.

Accessing Giga Pocket Help

For more information about Giga Pocket Personal Video Recorder, follow these steps:

1. Click **Start** in the Windows® taskbar and select **All Programs**.
2. Select **Giga Pocket, Help**, and click **Giga Pocket Help**.

Timer Recording Manager

The Timer Recording Manager keeps track of all scheduled TV recordings. Your computer settings, by default, are set to start Timer Recording Manager automatically when the computer is turned on.

Timer recordings are being performed when the icon  (Timer Recording Manager) is visible in the Windows taskbar. The timer recording does not start unless the Timer Recording Manager application is available. For the Timer Recorder Manager application to be available, your computer should be in Stand by or Hibernate mode, if the system is not in active use. You can schedule up to 100 programs at a time, for timer recording with the Timer Recording Manager.

 Microsoft® Windows® XP operating system supports a single Giga Pocket software user at any given time. If a different user logs on using the fast switch feature, the Timer Recording feature is not available to another user account. The Timer Recording Manager icon appears in the taskbar of the first user to log on.

Using the Timer Recording Manager

1. Click **Start** in the Windows® taskbar, select **All Programs**, select **Giga Pocket**, and then click **All Software**.
2. Click **Timer Recording Manager**.

The **Timer Recording Manager** window appears.

Timer Recording Manager



- **Windows Stand by** — Places the Windows operating system into Stand by mode until the preset timer recording is set to begin, or if a Video Capsule is set to expire. Windows system automatically starts and performs the appropriate action.
- **Interrupt Current Recording** — Stops the current timer recording. Use this option when you wish to end the current recording session.
- **Timer Recording List** — Displays a list of timer recordings that have been performed, as well as pending timer recordings. If a daily/weekly timer recording is set, only the current recording session is shown.

 The total number of timer recordings displayed does not exceed 100.

Double-click on a recorded timer recording to start playback in Giga Pocket software.

3. Click **Hide** to restore **Timer Recording Manager** to the taskbar.

 If you turn off your computer, the timer recording function is disabled.

Viewing your selected program recording schedule

You can easily view the programs you have selected to record, using Giga Pocket® Personal Video Recorder. The Timer Recording Manager feature enables you to change or cancel your timer recording at any time.

To view your scheduled timer recordings, follow these steps:

1. Double-click on the **Timer Recording Manager** icon , located in the Windows® taskbar.

Review your scheduled timer recordings and make any desired changes or cancellations.

2. Click **Hide** to return the icon to the taskbar.

 You do not have to be connected to the Internet to use the Timer Recording Manager feature.

Additional information about the Timer Recording Manager

- When creating a timer recording, it is important to remember the following information:
 - The timer recording function is disabled if you turn your computer off.
 - Your computer should be in Stand by or Hibernate mode, if the system is not in active use.
 - Disable screensavers and any other applications that may access your computer's hard disk drive during the timer recording.
 - If you are using a set-top box (STB), make sure it is turned on and set to the channel you want to record.
- When you set up a timer recording using Giga Pocket software, always use the Timer Recording Manager. If the Timer Recording Manager is not set up, the recording does not start, even if you set the timer recording settings with the Timer Recording Wizard.

 Your computer's default setting enables Timer Recording Manager to start automatically when the computer is started.

- The timer recording starts a few seconds earlier than the specified recording start time.
- Under certain circumstances, a daily or weekly timer recording may not be executed the second and subsequent times.
- A timer recording may fail if the computer's clock setting is changed right before the preset recording time. Before changing the computer's clock setting, verify that there are no timer recordings set to begin.

Close the Time Recording Manager before changing the computer's clock setting. Restart Timer Recording Manager after you have changed the time setting.

- If a different user logs on, using the Fast User Switch feature, the Timer Recording feature is not available to other user accounts. The Timer Recording Manager icon appears in the taskbar notification area for the first user to log on.

Accessing Giga Pocket Help

For more information about Giga Pocket Personal Video Recorder, follow these steps:

1. Click **Start** in the Windows® taskbar and select **All Programs**.
2. Select **Giga Pocket, Help**, and click **Giga Pocket Help**.

Giga Pocket Explorer

The Giga Pocket Explorer application serves as a file manager for your Video Capsules. Video Capsules are managed in Cabinets.

Giga Pocket Explorer enables you to play back Video Capsules using Giga Pocket. You can import MPEG files, that were created with compatible Sony applications, and export Video Capsules as AVI or MPEG files.

Using Giga Pocket Explorer





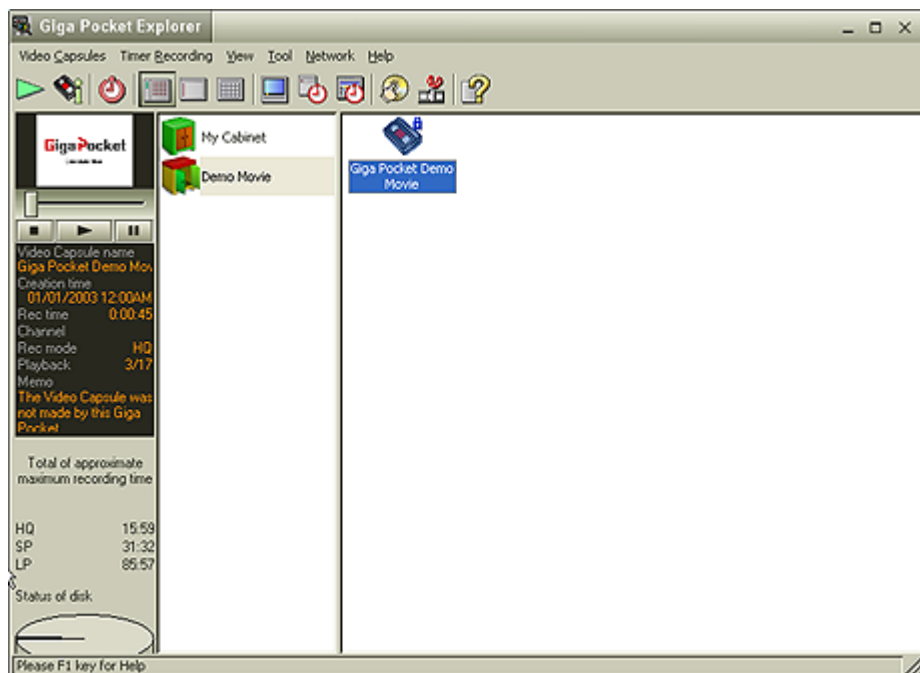







1. Click **Start** in the Windows taskbar, point to **All Programs**, point to **Giga Pocket**, point to **Giga Pocket Explorer**.
The **Giga Pocket Explorer** main window appears.
2. Click on the desired Cabinet to see a list of saved Video Capsules.

Giga Pocket Explorer



Using the Giga Pocket Explorer Toolbar functions

From the Giga Pocket Explorer toolbar, you can:

- Begin playing  a Video Capsule.
- Display information  about a Video Capsule.
- Set a new timer recording .
- Change the display views for your video contents.
 - Icon view .
 - List view .
 - Calendar view .
- Start Giga Pocket software  to play a selected Video Capsule.
- Start Timer Recording Wizard  to set up timer recordings.
- Access the Internet Electronic Program Guide  Web site.
- Start Click to DVD  software to burn Video Capsules to DVD recordable media. See Click to DVD software Help for more details.
- Start DVgate Plus  software to edit your Video Capsules.
- Start Giga Pocket Help  to obtain further assistance.

Accessing Click to DVD Help

For additional information about using Click to DVD software features, follow these steps to access the Help.

1. Click **Start** in the Windows® taskbar and point to **All Programs**.
2. Point to **Click to DVD** and click **Click to DVD Help**.

Accessing DVgate Plus Help

For additional information about using DVgate Plus software features, follow these steps to access the Help.

1. Click **Start** in the Windows taskbar and point to **All Programs**.
2. Point to **DVgate Plus** and click **DVgate Plus Help**.

Recording Video Capsules onto recordable DVD media

You can record Video Capsules to recordable DVD media with the Make DVD feature.

 The Click to DVD software must be installed in order to burn Video Capsules to recordable DVD media.

1. From the **Giga Pocket Explorer** main window, select the Video Capsules you want to burn onto a recordable DVD.
2. On the Giga Pocket Explorer Toolbar, click .
3. The Click to DVD software program starts. Follow the on-screen instructions.

Exporting Video Capsules

You can export your Video Capsules as MPEG-1, MPEG-2, or AVI file formats for viewing on external media.

1. In the list area, right-click the Video Capsule you want to export. A shortcut menu appears.
2. Select **Export**. The **Export** dialog box appears.

Export

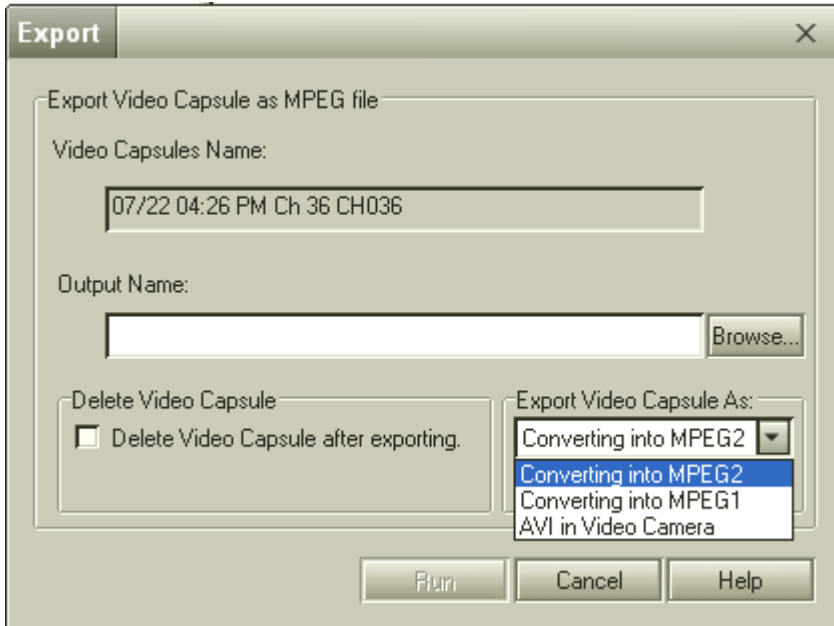

3. Enter an output name for the file you want to export and specify the location for the exported file.

You can select the option, **Delete Video Capsule after export**. If you do not want to delete the Video Capsule after export, leave the option disabled.

4. In the section, **Export Video Capsule As:**, select to convert to an AVI, MPEG-1, or MPEG-2 format.
5. Click **Run** to begin exporting.

 Some conversion formats may not be available, depending on the recording mode that was used to create the Video Capsule.

Additional information about using Giga Pocket Explorer

- Video Capsules that are recorded using High Quality (HQ) or Standard Play (SP) mode can be converted and exported as MPEG-1, MPEG-2, and AVI files. If you wish to play your Video Capsule in a different system environment, you can convert and export your Video Capsule using MPEG- 1 format.
- You can convert an imported MPEG file into a Video Capsule, only if the file was created using DVgate Plus or other VAIO AV software programs.

Using Network Cabinets

Giga Pocket Explorer enables you to connect to Video Capsules in network cabinets located on other computers in a network. These network cabinets can be accessed through the Giga Pocket Explorer main window when you are connected to the network.

Connecting to Network Cabinets

1. On the Giga Pocket Explorer menu, select **Network**, and then **Connect/Disconnect**. The **Connect/Disconnect Server** dialog box appears.

Connect/Disconnect Server

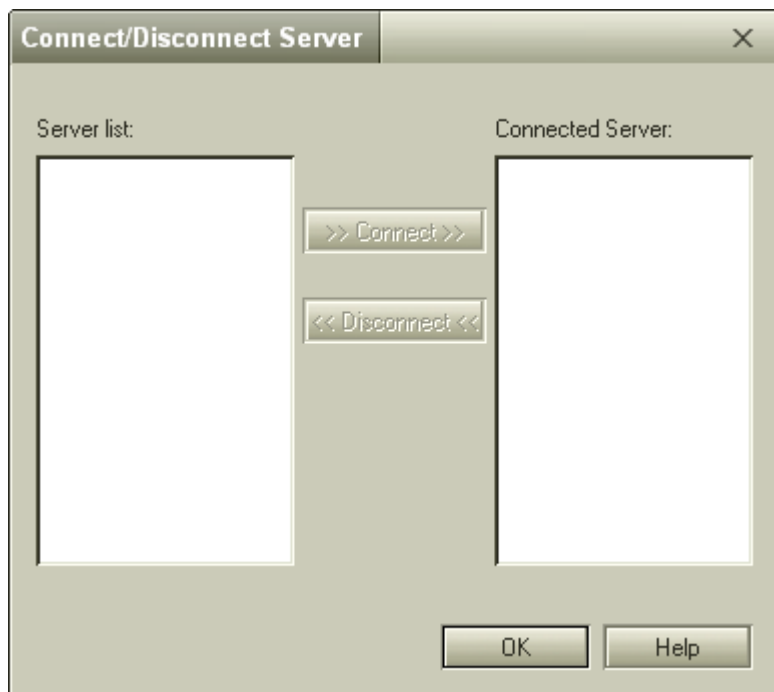

2. Select the server you want to connect to from the **Server list**.
3. Click **Connect** to add the selected server to the **Connected Server** list, then click **OK**. The server is connected.
4. To disconnect, repeat step 1, then select the server you want to disconnect from the **Connected Server** list.
5. Click **Disconnect**, then click **OK**. The server is disconnected.

Accessing Giga Pocket Help

For more information about Giga Pocket Personal Video Recorder, follow these steps:

1. Click **Start** in the Windows® taskbar and select **All Programs**.
2. Select **Giga Pocket, Help**, and click **Giga Pocket Help**.

CLIE Converter

The CLIE® Converter is a plug-in application that enables the conversion of Video Capsules. You can convert your Giga Pocket® Video Capsules and save to a Memory Stick® media, or synchronize directly to your Sony® CLIE® handheld using the HotSync® feature. In order to use the CLIE Converter plug-in application, make sure you have installed all required software for the CLIE handheld.

 The Sony CLIE handheld personal entertainment organizers provide a rich and compelling handheld computing experience. Powered by the Palm operating system, the CLIE handheld is ready to deliver music and video with amazing clarity. For more information on this exciting device, go to the Sony Style Web site at <http://sonystyle.com/vaio/clie>.

Starting CLIÉ Converter

1. Click **Start** in the Windows taskbar and point to **All Programs**.
2. Point to **Giga Pocket**, point to **Plug-ins**, and then click **CLIÉ Converter**. The **Giga Pocket -> CLIÉ Converter** main window appears.

Giga Pocket -> CLIÉ Converter



Converting Video Capsules

1. From the **Giga Pocket -> CLIÉ Converter** window, click the **Setting...** button. The Settings dialog box appears. Enter your desired settings and click **OK**.
2. Start Giga Pocket Explorer as follows:
 1. Click **Start** in the Windows taskbar, and then select **All Programs**.
 2. Select **Giga Pocket**, and then click **Giga Pocket Explorer**.
 3. Resize the **Giga Pocket Explorer** window so that the **Giga Pocket -> CLIÉ Converter** window is visible.
 4. Click on the **Cabinet** icon to display the contents in the list area.
 5. Drag the Video Capsule from the **Giga Pocket Explorer** window and drop it in the list area of the **Giga Pocket -> CLIÉ Converter** window. The Video Capsule automatically converts into a video file.

During conversion, the **Convert to CLIÉ** window appears, displaying the conversion status. When conversion is complete, the window automatically closes.

To convert multiple Video Capsules:

1. Hold down the **Ctrl** key while selecting Video Capsules in Giga Pocket Explorer.
2. Drag all selected Video Capsules to the **Giga Pocket -> CLIÉ Converter** window.

 The conversion process may take time, depending on the settings selected.

Transferring converted video files to a Memory Stick media

1. Insert a Memory Stick® media into the Memory Stick media slot on your computer.
2. From the **Giga Pocket -> CLIÉ Converter** main window, click to select the videos you want to transfer to the Memory Stick media.
3. Click **Send To**. The **Send To** dialog box appears.
4. Select **Using Memory Stick** as the transfer destination. Click **OK**.

During transfer, the **Forwarding** dialog box appears, displaying the transfer status.

5. When transfer is complete, click **OK**.

Your converted video files can be played back on CLIÉ handhelds that support the use of a Memory Stick media.

Transferring converted video files using the HotSync® operation

You can transfer your converted video files directly to your CLIÉ® handheld, when you start a HotSync operation.

1. From the **Giga Pocket -> CLIÉ Converter** main window, click to select the videos you want to transfer using the HotSync operation.
2. Click **Send To**. The **Send To** dialog box appears.
3. Select **Using HotSync** as the transfer destination. Designate a user name, if applicable to your handheld's configuration. Click **OK**.
4. The **Send to HotSync** dialog box appears. Follow the on-screen instructions and click **OK**.

 For more information about the HotSync operation, see the information supplied with your CLIÉ handheld.

Accessing CLIÉ Converter Help

For more information about using the CLIÉ Converter plug-in application, follow these steps:

1. Click **Start** in the Windows taskbar and point to **All Programs**.
2. Point to **Giga Pocket**, point to **Help**, and then click **CLIÉ Converter Help**.

Internet Electronic Program Guide Service

Internet Electronic Program Guide is a free, online service that enables quick and easy access to your local TV listings. You can use the Internet Electronic Program Guide service with your Giga Pocket® Personal Video Recorder for a "one-click" set up of timer recordings and record your favorite TV programs¹.

Giga Pocket Personal Video Recorder must be set up and configured correctly before you can use the Internet Electronic Program Guide service.

 You must read and accept the User Agreement before accessing the Internet Electronic Program Guide Web site (first time only). The Internet Electronic Program Guide service is available only to users in the United States.

¹ Unauthorized duplication of audio or video files is a violation of applicable laws.

Setting up your Internet Electronic Program Guide service

You must be connected to the Internet, before setting up your Internet Electronic Program Guide service.

 Sony recommends using Microsoft® Internet Explorer as your Web browser to access the Internet Electronic Program Guide service.

To set up Internet Electronic Program Guide service, follow these steps:

1. Click **Start** in the Windows® taskbar and point to **All Programs**.
2. Point to **Giga Pocket**, then click **TV Program Web site**. Microsoft® Internet Explorer starts, and you are directed to the Internet Electronic Program Guide Web site.
3. The **Terms of Use** window appears. Click **I accept**, to continue.

The **Welcome and Registration** window appears.

Internet Electronic Program Guide Welcome and Registration

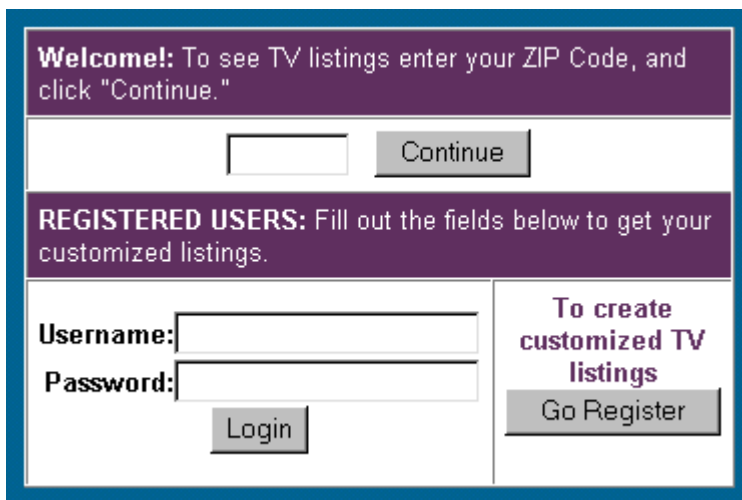

Welcome!: To see TV listings enter your ZIP Code, and click "Continue."

REGISTERED USERS: Fill out the fields below to get your customized listings.

Username:

Password:

To create customized TV listings

4. In the **Welcome!** section, enter your 5-digit zip code and click **Continue**. The **Choose Your Provider** window appears, listing all TV providers or TV services available in your area.
5. Select your TV provider and then click **Confirm Channel Lineup**. The **Confirm Lineup** window appears, listing available channels by number and name.
6. Click **Yes** if the channel lineup is correct. If channel lineup is incorrect, click **No** and repeat steps 3 and 4 until you locate the correct channel lineup.
7. Your TV listings appear in table format, organized by time and channel. Click **Download All Channel Settings** to set your channels. The **TV Setup Wizard** appears, if this is the first time you have used this download feature. Click **OK**.

 Close all Giga Pocket® applications before downloading your TV listings.

If you are using set-top box (STB) mode, you do not need to click Download All Channel Settings. Giga Pocket software only schedules timer recordings when using STB mode.

8. Verify the channel settings and click **OK**.
9. Your personal channel settings appear whenever you access the Internet Electronic Program Guide Web site.

 If your TV provider adds new channels or changes existing channels, an Update icon appears next to Download All Channel Settings. Click **Update** to add the new or updated channels to your personal channel setting.

Memory Upgrades

Before you upgrade your computer's memory, read the safety information in [Precautions and Procedures](#). For the type of module and amount of memory installed on your computer, refer to the VAIO® Computer Specifications.

 **Sony recommends that memory upgrades be performed by an authorized Sony Service Center. To find the nearest center or agent, go to: <http://www.sony.com/pcsupport>.**

The procedures described below assume familiarity with the general terminology associated with personal computers and with the safety practices and regulatory compliance required for using and modifying electronic equipment. When installing a memory module in your computer, make sure you read the proper safety precautions below. Mistakes that occur when installing or removing a memory module may cause a malfunction.

- Turn off the computer. Disconnect the computer from its power source and from any telecommunications links, networks, or modems before you install or remove a memory module. Failure to do so may result in personal injury or equipment damage.
- Introducing any liquids or any foreign substances or objects into the memory slots, or other internal components of the computer, will result in damage to the computer.
- Electrostatic discharge (ESD) can damage disk drives, memory modules, and other components. Perform the procedures described below only at an ESD workstation. If such a station is not available, do not work in a carpeted area, and do not handle materials that produce or hold static electricity (cellophane wrappers, for example). Ground yourself by momentarily touching an unpainted metal object that is grounded, such as a pipe, radiator, or faucet.
- Do not open the memory module package until you are ready to install the module. The package protects the module from ESD.
- Use the special protective package to store a memory module and prevent ESD.
- Only use memory modules that are compatible with your computer. For the type of module and amount of memory installed on your computer, refer to the VAIO® Computer Specifications. If you wish to purchase a memory module, shop Sony online at <http://www.sonymstyle.com/vaio> or contact your local retailer.

Removing and Installing Memory Modules

Make sure you read the safety information in [Precautions and Procedures](#) before you remove or install a memory module. When installing a memory module, do not open the module package until you are ready to install it. The package protects the module from Electrostatic discharge (ESD).

 The hardware configuration of your computer may vary from the illustrations shown. For information about the specific hardware configuration for your computer, memory upgrades, and which memory modules to use, refer to your VAIO® Computer Specifications.

Option 1

The following instructions illustrate how to remove the memory module located underneath the bottom panel of the computer.

To remove a memory module

1. Turn off the computer and all attached devices.
2. Disconnect the power cord, all cables, and remove the battery if it is installed. See [Removing a battery](#).
3. Wait for the computer to cool down.

 The interior of the computer becomes extremely hot during operation. Wait at least one hour for the computer to cool down before you remove the screws.

4. Turn the computer over and use a screwdriver to loosen and remove the screw(s) on the memory bay.

 **To avoid damaging the computer, do not remove or loosen any other screws.**

Removing the Bottom Screw(s)

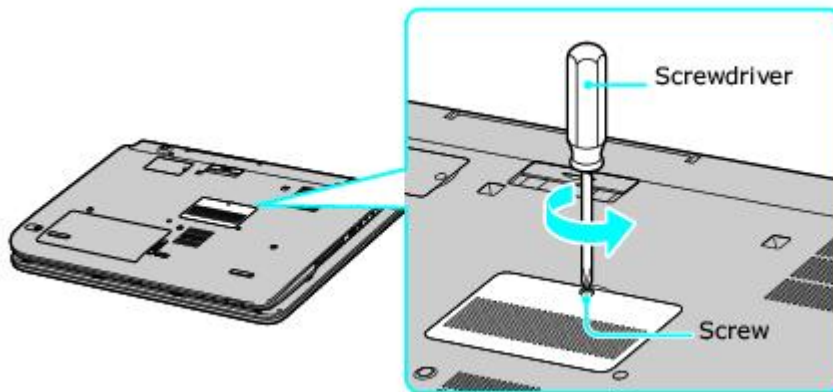

5. Remove the memory bay cover carefully.
6. Touch a metal object (such as the connector panel on the back of your computer) to discharge static electricity.

 **Avoid touching any part of the motherboard or other components inside the computer.**

7. Remove the memory module by pulling out the tabs (see arrows No. 1), and pulling out the module in the direction of arrow No. 2. See [To install a memory module](#) for more information.

Removing a Memory Module



To install a memory module

1. Remove the new memory module from its packaging, and install the memory module by sliding it into the open slot at a 45-degree angle. See [To remove a memory module](#).

Installing a New Memory Module

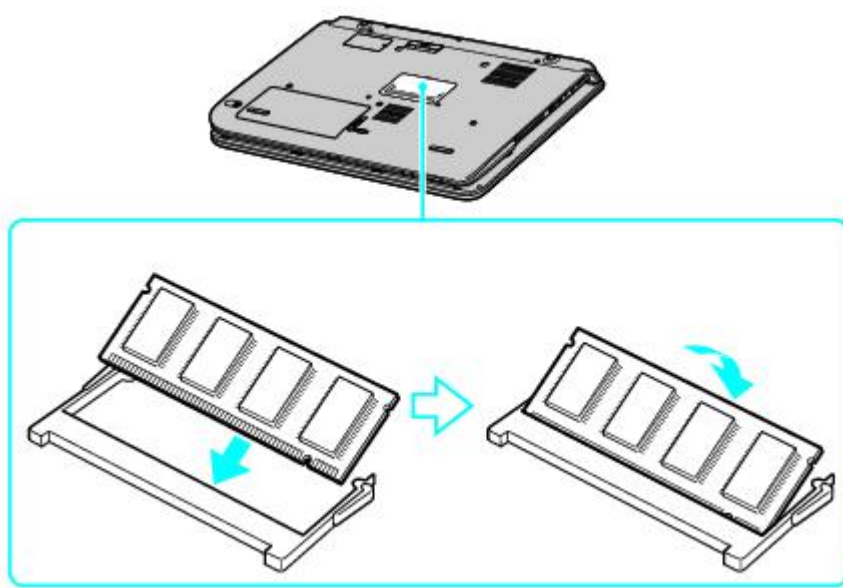

2. Push the module down until it snaps into place.
3. When the module is correctly seated, close the memory bay.
4. Replace the fastening screw(s) on the memory bay.
5. Make sure the system recognizes the new memory module. See [Confirming Added Memory Capacity](#) for more information.

Option 2

The following instructions illustrate how to remove the memory module located underneath the keyboard.

To remove a memory module

1. Turn off the computer and all attached devices.
2. Disconnect the power cord, all cables, and remove the battery if it is installed. See [Removing a battery](#).
3. Wait for the computer to cool down.

 The interior of the computer becomes extremely hot during operation. Wait at least one hour for the computer to cool down before you remove the screws.

4. Turn the computer over and use a screwdriver to loosen and remove the two screws on the bottom of the computer.

 **To avoid damaging the computer, do not remove or loosen any other screws.**

Removing the Bottom Screw(s)

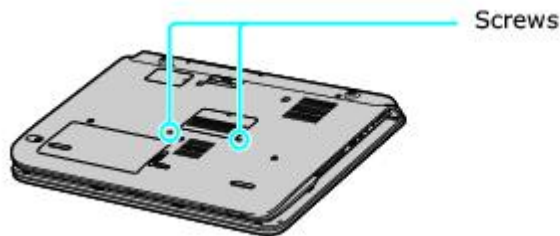

5. Position the computer so you are looking at the keyboard, and place your fingers behind the last row of keys.
6. Gently lift the keyboard up and turn it over the touch pad. Do not detach the cable when lifting the keyboard.

Lifting the Keyboard

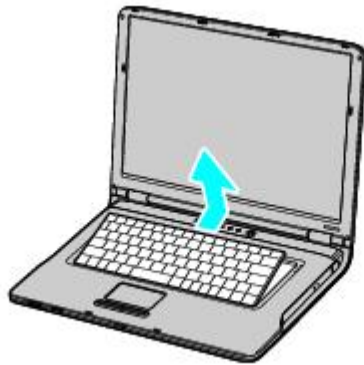

Turning the Keyboard

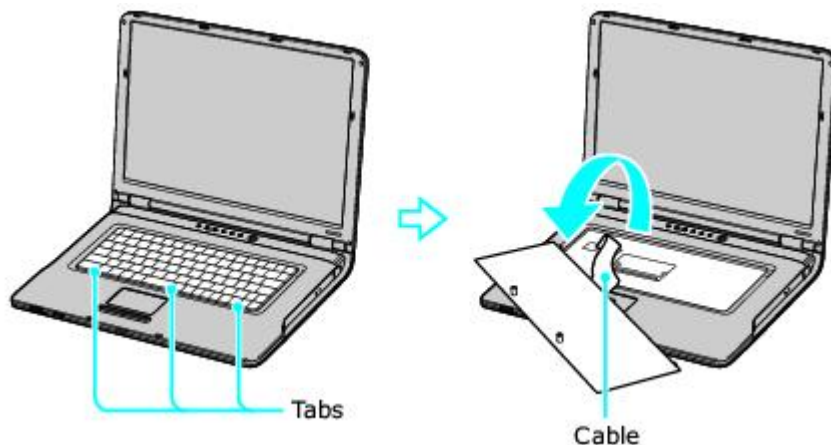

7. Touch a metal object (such as the connector panel on the back of your computer) to discharge static electricity.



Avoid touching any part of the motherboard or other components inside the computer.

8. Remove the memory module by pulling out the tabs (see arrows No. 1), and pulling out the module in the direction of arrow No. 2. See [To install a memory module](#) for more information.

Removing a Memory Module

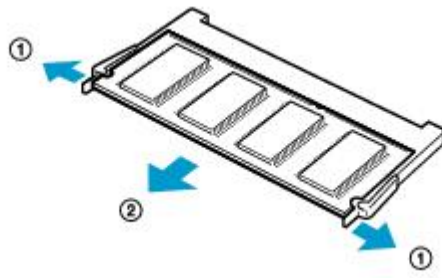

To install a memory module

1. Remove the new memory module from its packaging, and install the memory module by sliding it into the open slot at a 45-degree angle. See [To remove a memory module](#).

Installing a New Memory Module

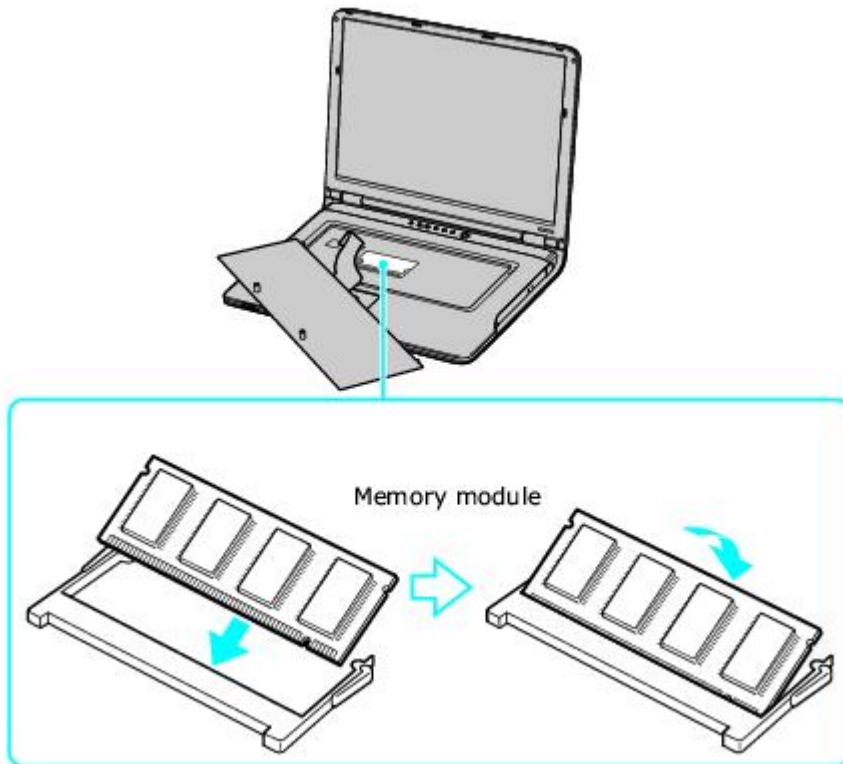

2. Push the module down until it snaps into place.
3. When the module is correctly seated, gently flip the keyboard back over the computer, making sure the keyboard is also correctly seated.
4. Replace the fastening screws on the bottom of the computer.
5. Make sure the system recognizes the new memory module. See [Confirming Added Memory Capacity](#) for more information.

Confirming Added Memory Capacity

After you have installed a new memory module, make sure the operating system recognizes it.

To check your system's memory

1. Turn on the computer.
2. Click **Start** on the Windows® taskbar, point to **All Programs**, and then point to **Sony Notebook Setup**.
3. Select **Sony Notebook Setup** from the submenu. The **Sony Notebook Setup** dialog box appears.
4. On the **About This Computer** tab, make sure the **System Memory** displayed in the **System Information** box matches the amount of memory installed.

⚠ The displayed memory may be less than the installed memory due to the amount used by the display adapter.

Sony Notebook Setup

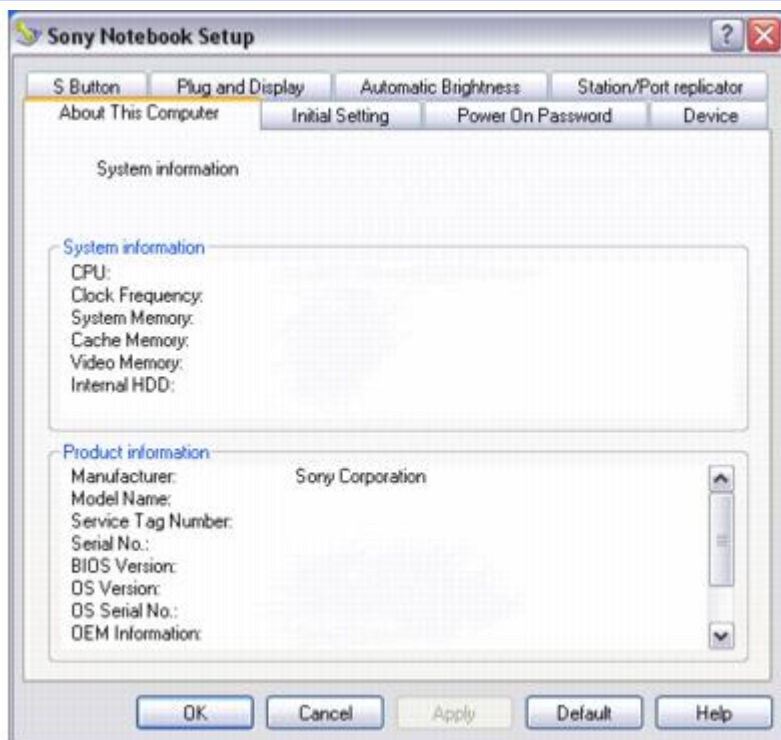

What do I do if my computer won't start?

- Make sure the computer is securely plugged into a power source and turned on. Make sure the power indicator shows the power is on.
- Make sure the battery is inserted properly and charged.
- Make sure the floppy disk drive (if applicable) is empty.
- If the computer is plugged into a power strip or uninterruptible power supply (UPS), make sure the power strip or UPS is turned on and working.
- If you are using an external display, make sure it is plugged into a power source and turned on. Make sure the brightness and contrast controls are adjusted correctly. See the guide that came with your display for details.
- Disconnect the AC adapter and remove the battery. Wait three to five minutes. Reattach the AC adapter and reinsert the battery, and press the Power button to turn on the computer.
- Condensation may cause the computer to malfunction. If this occurs, do not use the computer for at least one hour.

 For further instructions, contact Sony Computing Support (<http://www.sony.com/pcsupport>).

What do I do if my computer won't start?

- Make sure the computer is securely plugged into a power source and turned on. Make sure the power indicator shows the power is on.
- Make sure the battery is inserted properly and charged.
- Make sure the floppy disk drive (if applicable) is empty.
- If the computer is plugged into a power strip or uninterruptible power supply (UPS), make sure the power strip or UPS is turned on and working.
- If you are using an external display, make sure it is plugged into a power source and turned on. Make sure the brightness and contrast controls are adjusted correctly. See the guide that came with your display for details.
- Disconnect the AC adapter and remove the battery. Wait three to five minutes. Reattach the AC adapter and reinsert the battery, and press the Power button to turn on the computer.
- Condensation may cause the computer to malfunction. If this occurs, do not use the computer for at least one hour.

 For further instructions, contact Sony Computing Support (<http://www.sony.com/pcsupport>).



What do I do if my computer won't start?

- Make sure the computer is securely plugged into a power source and turned on. Make sure the power indicator shows the power is on.
- Make sure the battery is inserted properly and charged.
- Make sure the floppy disk drive (if applicable) is empty.
- If the computer is plugged into a power strip or uninterruptible power supply (UPS), make sure the power strip or UPS is turned on and working.
- If you are using an external display, make sure it is plugged into a power source and turned on. Make sure the brightness and contrast controls are adjusted correctly. See the guide that came with your display for details.
- Disconnect the AC adapter and remove the battery. Wait three to five minutes. Reattach the AC adapter and reinsert the battery, and press the Power button to turn on the computer.
- Condensation may cause the computer to malfunction. If this occurs, do not use the computer for at least one hour.

 For further instructions, contact Sony Computing Support (<http://www.sony.com/pcsupport>).



What do I do if a BIOS error appears when my computer starts?

If the message "Press <F1> to resume, <F2> to setup" appears at the bottom of the screen, follow these steps:

1. Press the **F2 key**. The **BIOS Setup** menu appears.
2. Set the date (month/day/year). Press **Enter**.
3. Press the **Down Arrow** key  to select **System Time**, and then set the time (hour: minute: second). Press **Enter**.
4. Press the **Right Arrow** key  to select the **Exit** tab, and then press the **Down Arrow** key  to select **Get Default Values**. The message **Load factory default values** appears.
5. Press the **Enter** key. The **Load Optimal Defaults?** window appears.
6. Select **Ok**, and press **Enter**.
7. Select **Exit (Save Changes)**, and press **Enter**. The **Save configuration changes and exit setup?** window appears.
8. Select **Ok**, and press **Enter**. The computer restarts.

 If this occurs on a regular basis, contact Sony Computing Support (<http://www.sony.com/pcsupport>).

What do I do if the message "Operating system not found" appears when my computer starts, and why won't Windows start?

- Make sure the computer does not have a "non-bootable" floppy disk in the floppy disk drive (if applicable).
- If a non-bootable floppy disk is in the drive:
 1. Remove the floppy disk.
 2. Restart the computer and confirm that the Microsoft® Windows® operating system starts properly.
- If the Windows operating system still does not start, follow these steps to initialize the BIOS:
 1. If there is a disk in the floppy disk drive, then remove it.
 2. Turn off the computer.
 3. Remove any peripheral devices connected to the computer.
 4. Restart the computer.
 5. Press the **F2 key** when the Sony logo appears. The **BIOS Setup** window appears.
 6. Press the **Right Arrow** key  to select the **Exit** menu.
 7. Press the **Down Arrow** key  to select **Get Default Values**. The message **Load factory default values** appears.
 8. Press the **Enter** key. The **Load Optimal Defaults?** window appears.
 9. Select **Ok**, and press **Enter**.
 10. Select **Exit (Save Changes)**, and press **Enter**. The **Save configuration changes and exit setup?** window appears.
 11. Select **OK**, and press **Enter**. The computer restarts.

What do I do if my computer stops responding?

It is best to turn off your computer using the Turn Off Computer option on the Microsoft® Windows® Start menu, located on the taskbar. Using other methods, including those listed below, may result in loss of unsaved data.

- Click **Start** on the Windows® taskbar, select **Turn Off Computer**, and then click **Turn Off**.
- If your computer does not turn off, press the **Ctrl+Alt+Delete** keys simultaneously. When the **Windows Task Manager** dialog box appears, click **Turn Off** from the **Shut Down** menu.
- If your computer still does not turn off, press and hold the power button or slide and hold the power switch until the computer turns off.
- If your computer stops responding while playing a CD or DVD, press the **Ctrl+Alt+Delete** keys simultaneously. You can turn off the computer from the **Windows Task Manager**.



 Pressing the **Ctrl+Alt+Delete** keys simultaneously or turning off the computer with the power button or switch may cause loss of data.

- Remove the AC adapter and battery.

Why won't my computer enter Standby or Hibernate mode?

Your computer may become unstable if the operating mode is changed before the computer completely enters Standby or Hibernate.

To restore the computer to normal operating stability:

1. Close all open programs.
2. Restart the computer. Follow these steps:
 1. Press the **Windows** key .
 2. Press **U**.
 3. Press **R** to select restart.
3. If the computer does not restart, follow these steps:
 1. Press the **Ctrl+Alt+Delete** keys simultaneously. The **Windows Task Manager** window appears.
 2. Press and release **Alt** to highlight the menu bar, and press the **Right Arrow**  key to select Shut Down.
 3. Press **Enter**.
 4. Press **R** to select restart.
4. If this procedure does not work, press and hold the power button or slide and hold the power switch until the computer turns off.

Why is the sound of my computer's fan so loud?

The computer's fan may be running at a high speed to cool the CPU. By lowering the CPU speed, you also lower the speed and noise level of the computer's fan. Use the power schemes to lower the CPU speed.

To lower the CPU speed using the power schemes:

1. Click **Start** on the Windows® taskbar, and click **Control Panel**.
2. Click **Performance and Maintenance**, and click **Power Options**. The **Power Options Properties** window appears.
3. Select **Portable/Laptop** in the **Power schemes** box.
4. Click **Apply**.
5. Click **OK**.

Why does the System Properties dialog box display a slower CPU speed than the maximum?

This is normal. Because your computer's CPU utilizes a type of CPU speed controlling technology for power conservation purposes, System Properties may display the CPU's current speed instead of the maximum speed.

Why don't my changes appear on the computer screen (LCD)?

You may need to refresh the computer screen. Press and hold the **Windows** key  , and press **D** twice.

This section provides information about keeping your computer operating smoothly and protecting against potential threats to your system security.

How can I protect my system against security threats, such as viruses?

The Microsoft® Windows® operating system is preinstalled on your computer. The best way to protect your computer against security threats, such as viruses, is to download and install the latest Windows updates regularly.

You can get important Windows updates by doing one of the following:

- **The Automatic Updates** feature — This feature automatically searches for and delivers updates directly to your computer whenever you are connected to the Internet.
- **The Windows Updates Web site** — This site enables you to download computer updates without turning on the **Automatic Updates** feature.

 Your computer must be connected to the Internet before you can receive updates.

To use the Automatic Updates feature

1. Connect to the Internet.
2. Click the **Automatic Updates**  icon in the Taskbar notification area.

The **Automatic Updates Setup Wizard** appears.

3. Click **Next**, and follow the on-screen instructions to set up automatic or scheduled updates.

To visit the Windows Updates Web site

1. Connect to the Internet.
2. Type <http://windowsupdate.microsoft.com/> in the address bar of your browser.

The **Microsoft Windows Update** and **Security Warning** windows appear.

3. In the **Security Warning** window, click **Yes to install and run Windows Update**.
4. In the **Microsoft Windows Update** window, click **Scan for updates**, and follow the on-screen instructions.

This section provides information about keeping your computer operating smoothly and protecting against potential threats to your system security.

How can I protect my system against security threats, such as viruses?

The Microsoft® Windows® operating system is preinstalled on your computer. The best way to protect your computer against security threats, such as viruses, is to download and install the latest Windows updates regularly.

You can get important Windows updates by doing one of the following:

- **The Automatic Updates** feature — This feature automatically searches for and delivers updates directly to your computer whenever you are connected to the Internet.
- **The Windows Updates Web site** — This site enables you to download computer updates without turning on the **Automatic Updates** feature.

 Your computer must be connected to the Internet before you can receive updates.

To use the Automatic Updates feature

1. Connect to the Internet.
2. Click the **Automatic Updates**  icon in the Taskbar notification area.

The **Automatic Updates Setup Wizard** appears.

3. Click **Next**, and follow the on-screen instructions to set up automatic or scheduled updates.

To visit the Windows Updates Web site

1. Connect to the Internet.
2. Type <http://windowsupdate.microsoft.com/> in the address bar of your browser.

The **Microsoft Windows Update** and **Security Warning** windows appear.

3. In the **Security Warning** window, click **Yes to install and run Windows Update**.
4. In the **Microsoft Windows Update** window, click **Scan for updates**, and follow the on-screen instructions.

What is the best way to set up firewall protection for my computer?

Using firewall protection is an important way to protect your computer from security threats that may occur when your computer is connected to the Internet. Your computer's preinstalled Microsoft® Windows® operating system has a built-in Internet Connection Firewall (ICF) feature that you can use to protect your computer.

Using the ICF feature may interrupt the file and print sharing features for preinstalled networking software programs, such as VAIO Media software. As an alternative, Sony suggests installing a router as a hardware-based firewall solution. A router box protects your computer and allows your network to run without interruption.

To disable the ICF feature

1. Click **Start** in the Windows® taskbar, and then click **Control Panel**.
2. Click **Network and Internet Connections**.
3. Click **Network Connections**.
4. In the section, **LAN or High-Speed Internet**, right-click the icon of the connection you want to protect.

A shortcut menu appears.
5. Select **Properties** from the shortcut menu.
6. On the **Advanced** tab, under **Internet Connection Firewall**, clear the check box for **Protect my computer and network by limiting or preventing access to the computer from the Internet**.
7. Click **OK** to disable the ICF feature.

How do I keep my preinstalled antivirus software updated?

You can keep the preinstalled Norton Internet Security software program current with the latest updates from Symantec Corporation.

To download and install the latest security update

1. Double-click the **Norton Internet Security** icon  in the Taskbar notification area.

If you have not previously registered the antivirus software, a series of information wizards appear.

1. Follow the on-screen instructions to complete each wizard
2. Double-click the **Norton Internet Security** icon again.

The **Norton Internet Security** window appears.

 If you have previously registered this antivirus software, the **Norton Internet Security** window automatically appears.

2. Click **Live Update**, located near the top of the window.
3. Follow the on-screen instructions to select and download updates.

How do I know when the battery is charged?

To determine the remaining battery charge, see [Locating battery information.](#)

How do I know when the battery is charged?

To determine the remaining battery charge, see [Locating battery information.](#)

When is the computer using AC power?

When the computer is directly connected to the AC adapter, it uses AC power, even if a battery is installed.

When should I recharge the battery?

- When the battery level falls below 10 percent.
- When both the battery and power indicators blink.
- When you have not used the battery for a long time.

When should I replace the battery?

If the battery power is still low after charging it, the battery may be reaching the end of its life and should be replaced.

Should I be concerned that the installed battery is warm?

No, it is normal for the battery to be warm when it is powering the computer.

Can my computer enter Hibernate mode while using battery power?

Your computer can enter Hibernate mode while using battery power, but some software programs and peripheral devices prevent the system from entering Hibernate mode. If you are using a program that prevents the system from entering Hibernate mode, save your data frequently to avoid losing data. See [To activate Hibernate mode](#) for information on how you can manually activate Hibernate mode.

Why doesn't my computer enter Hibernate mode?

You may first need to enable Hibernate mode. Follow these steps:

1. Click **Start** on the Windows® taskbar, and click **Control Panel**.
2. Click **Performance and Maintenance**, and click **Power Options**. The **Power Options Properties** window appears.
3. Select the **Hibernate** tab.
4. Click to check the box next to **Enable hibernation**.

Why doesn't my modem work?

- Make sure the telephone cable is securely plugged into the Modem jack on the computer and the wall jack.
- Make sure the telephone cable is working. Plug the cable into an ordinary telephone and listen for a dial tone.
- Make sure the telephone number the program is dialing is correct.
- Make sure the software you are using is compatible with the computer's modem. (All preinstalled Sony programs are compatible.)

Why doesn't my modem work?

- Make sure the telephone cable is securely plugged into the Modem jack on the computer and the wall jack.
- Make sure the telephone cable is working. Plug the cable into an ordinary telephone and listen for a dial tone.
- Make sure the telephone number the program is dialing is correct.
- Make sure the software you are using is compatible with the computer's modem. (All preinstalled Sony programs are compatible.)

Why is my modem connection slow?

Your computer is equipped with a V.90 compatible modem. Many factors may influence modem connection speed, including telephone line noise or compatibility with telephone equipment, such as fax machines or other modems. If you think your modem is not connecting properly to other PC-based modems, fax machines, or your Internet Service Provider (ISP), follow these steps:

- Ask your telephone company to verify your telephone line is free of any line noise.
- If your problem is fax-related, make sure there are no problems with the fax machine you are calling and that it is compatible with fax modems.
- If you are having a problem connecting with your ISP, make sure the ISP is not experiencing technical problems.
- If you have a second telephone line, try connecting the modem to that line.

Why can't my computer connect to a wireless LAN access point?

- Connection availability is affected by distance and obstructions. You may need to move your computer away from obstructions or closer to any access point you may be using.
- Make sure the Wireless LAN switch on the computer is on.
- Make sure power to the access point is on.
- Make sure the access point is displayed in the Available networks window.
- Make sure the encryption key is correct.

Why can't my computer connect to a wireless LAN access point?

- Connection availability is affected by distance and obstructions. You may need to move your computer away from obstructions or closer to any access point you may be using.
- Make sure the Wireless LAN switch on the computer is on.
- Make sure power to the access point is on.
- Make sure the access point is displayed in the Available networks window.
- Make sure the encryption key is correct.

Why can't I access the Internet?

- Check the access point settings. Refer to the instructions supplied with the access point.
- Make sure your computer and the access point are connected to one another.
- Move your computer away from obstructions or closer to any access point you may be using.
- Make sure your computer is properly configured for Internet access.

Why is the data transfer speed slow?

- The wireless LAN data transfer speed is affected by distance and obstructions between devices and access points. Other factors include device configurations, radio conditions, and software compatibility. To maximize the data transfer speed, move your computer away from obstructions or closer to any access point you may be using.
- If you are using a wireless LAN access point, the device may be temporarily overloaded depending on how many other devices are communicating via the access point.
- If your access point interferes with other access points, change the access point channel. See your access point instructions for more information.

Why is the communication speed interrupted or slowed down when MPEG2 data is transferred?

The typical effective data transfer speed via an access point is 4-5 Mbps when adhering to the IEEE 802.11b standard or both the IEEE 802.11b and IEEE 802.11g standards (selected models only). High-rate stream transfers with MPEG2 data may lower this rate.

How do I avoid data transfer interruptions?

- When your computer is connected to an access point, data transfer interruptions may occur when using large files or if the computer is in close proximity to microwaves and cordless telephones.
- Move the computer closer to the access point.
- Make sure the access point connection is intact. For more information, see [Checking your network connection status](#).
- Change the access point channel. See your access point instructions for more information.

Can I connect to an IEEE 802.11a device?

Computers with built-in wireless LAN support the IEEE 802.11b standard only. Devices connecting to a wireless LAN using the IEEE 802.11a standard cannot connect to devices using the IEEE 802.11b standard.

What are channels?

Wireless LAN communication occurs on divided frequency bands known as channels. Third-party wireless LAN access point channels may be preset to different channels from Sony devices.

If you are using a wireless LAN access point, refer to connectivity information contained in your access point instructions.

When I change the encryption key, the network connection stops. What do I do?

Two computers with built-in wireless LAN may lose a peer-to-peer network connection if the encryption key is changed. You can either change the encryption key back to the original profile or restart both computers.

How do I maintain CDs and DVDs?

- Avoid touching the surface of the disc with your fingers. Fingerprints and dust on the surface of the disc may cause reading errors.
- Try using canned compressed air to clean dusty discs.
- Do not clean the disc with solvents (such as benzine, thinner, alcohol, commercially available cleaners, or anti-static spray), which may damage the disc. To clean the disc, follow these steps:
 1. Hold the edge of the disc, and use a soft cloth to wipe the surface from the center out.
 2. If the disc is badly soiled, moisten a soft cloth with water, wring it out well, and use it to wipe the surface of the disc from the center out.
 3. Wipe off any remaining moisture with a dry, soft cloth.
- Do not drop or bend the disc.

How do I maintain CDs and DVDs?

- Avoid touching the surface of the disc with your fingers. Fingerprints and dust on the surface of the disc may cause reading errors.
- Try using canned compressed air to clean dusty discs.
- Do not clean the disc with solvents (such as benzine, thinner, alcohol, commercially available cleaners, or anti-static spray), which may damage the disc. To clean the disc, follow these steps:
 1. Hold the edge of the disc, and use a soft cloth to wipe the surface from the center out.
 2. If the disc is badly soiled, moisten a soft cloth with water, wring it out well, and use it to wipe the surface of the disc from the center out.
 3. Wipe off any remaining moisture with a dry, soft cloth.
- Do not drop or bend the disc.

Why does my computer freeze when I try to read a disc?

- The disc your computer is trying to read may be dirty or damaged. Follow these steps:
 1. Restart the computer by clicking **Start, Turn Off Computer**, and **Restart**.
 2. Eject the disc from the optical drive.
 3. Examine the disc for dirt or damage. If the disc is dirty, see [How do I maintain CDs and DVDs?](#) for instructions on how to clean it.

What do I do if the drive tray won't open?

- Make sure the computer is on.
- Press the Eject button on the optical drive.
- If the Eject button does not work, click **Start** on the Windows® taskbar, and click **My Computer**. Right click the optical drive icon, and select **Eject** from the shortcut menu.
- If none of the above options work, insert a thin, straight object (such as a paper clip) in the manual eject hole near the Eject button.

What do I do if the optical drive isn't playing my CD or DVD properly?

- Make sure the disc was inserted into the drive with the label facing up.
- Make sure the necessary program(s) is installed according to the manufacturer's instructions.
- If the CD or DVD is dirty or damaged, the computer will stop responding. Follow these steps:
 1. Restart the computer by pressing the **Ctrl+Alt+Delete** keys, and selecting **Restart** from the **Shut Down** menu of the **Windows Task Manger** dialog box.
 2. Remove the CD or DVD from the optical drive.
 3. Check the disc for dirt or damage. If you need to clean the disc, see [How do I maintain CDs and DVDs?](#) for instructions.
- If you are playing a CD or DVD and cannot hear sound, follow these steps:
 1. Double-click the **Volume** icon  on the **Taskbar Notification** area, and click to cancel the **Volume Control Mute All** and **Wave Mute** check boxes.
 2. Check the volume setting in the audio mixer.
 3. If you are using external speakers, check the volume settings on the speakers and the connections between the speakers and the computer.
 4. Make sure the CD audio feature is enabled and the correct driver software is installed. Follow these steps:
 5. Click **Start** on the Windows® taskbar, click **Control Panel, Performance and Maintenance**, and **System**. The **System Properties** window appears.
 6. Select the **Hardware** tab, and click **Device Manager** in the **Device Manager** box. A window with a listing of the computer's hardware devices appears.

 If an "X" or an exclamation point appear on the listed device, you may need to enable the device or reinstall the drivers.
 7. Double-click the optical drive device to open the submenu.
 8. Double-click the listed drive, and select the **Properties** tab.
 9. Click to select the **Enable digital CD audio for this CD-ROM device** check box, if it is not selected.

 You can confirm the driver software by selecting the **Driver** tab, and clicking **Driver Details**.
- 10. Click **OK** to close the window.
- Make sure an adhesive label was not attached to the CD or DVD. Adhesive labels can come off while the disc is in the optical drive and damage the drive or cause it to malfunction.
- If a region code warning appears, the disc may be incompatible with the optical drive. Check the DVD package to make sure the region code is compatible with the optical drive.
- If you notice condensation on the computer, do not use the computer for at least one hour. Condensation can cause the computer to malfunction.

Why did the computer screen (LCD) go blank?

- Your computer screen may go blank if the computer has lost power or has entered a power saving mode (Standby or Hibernate). If the computer is in LCD (Video) Standby mode, press any key to activate the computer screen. See [Using power saving modes](#) for more information.
- Make sure the computer is plugged into a power source and is on. The power indicator on the computer will be on if the computer is on.
- If your computer is using battery power, make sure the battery is inserted properly and is charged. See [Using the Battery](#) for more information.
- If the display mode is set to external display, use the **Fn+F7** key combination. See [Selecting a display](#) for more information.

Why can't I view the entire DVD video display on a TV screen?

The display resolution may not be properly set. To adjust the display resolution, see [Selecting a display](#) for more information. It is recommended that you adjust the display resolution to 1024 x 768 or smaller, depending on the size of the external display screen.

How do I adjust the image on the TV screen?

Use the controls on your external display to adjust the image. See the help guide that accompanied your display for more information.

How do I change the video resolution on the TV screen?

The video may not appear on the entire TV screen if your computer resolution is set larger than 1024 x 768. Adjust the video resolution to 1024 x 768 or smaller.

 If you are using the A/V Out jack, plug the audio-video (AV) cable into the computer before you start the computer.

To change the video resolution, follow these instructions:

1. Right-click the desktop, and select **Properties** from the shortcut menu. The **Display Properties** dialog box appears.
2. Select the **Settings** tab.
3. Move the screen resolution slider to the left to reduce the size and to the right to increase the size of the video resolution.

How do I switch the computer screen (LCD) from LCD to TV?

Press the **Fn+F7** keys to view the image on either the computer screen (LCD) or the TV. See [Selecting a display](#) for more information.

Why can't I print a document?

- Make sure the printer is on, and the printer cable is securely connected to the ports on your printer and computer.
- Make sure the printer is compatible with the Microsoft® Windows® operating system installed on your computer.
- You may need to install the printer driver software before you use the printer. See the guide that accompanied the printer for more information.
- If the printer is not functioning after the computer resumes from a power saving mode (Standby or Hibernate), then restart the computer.
- If the bidirectional communication functions are provided with your printer, disabling the functions on your computer may enable printing. Follow these steps:
 1. Click **Start**, and then **Control Panel**.
 2. Click **Printers and Other Hardware**.
 3. Click **Printers and Faxes**.
 4. Right-click an unused printer and select **Properties**.
 5. Click the **Ports** tab.
 6. Click to cancel the **Enable bidirectional support** check box.
 7. Click **OK**.

 This change to the settings disables the bidirectional communication functions of your printer, such as data transfer, status monitoring, and remote panel.

Why can't I print a document?

- Make sure the printer is on, and the printer cable is securely connected to the ports on your printer and computer.
- Make sure the printer is compatible with the Microsoft® Windows® operating system installed on your computer.
- You may need to install the printer driver software before you use the printer. See the guide that accompanied the printer for more information.
- If the printer is not functioning after the computer resumes from a power saving mode (Standby or Hibernate), then restart the computer.
- If the bidirectional communication functions are provided with your printer, disabling the functions on your computer may enable printing. Follow these steps:
 1. Click **Start**, and then **Control Panel**.
 2. Click **Printers and Other Hardware**.
 3. Click **Printers and Faxes**.
 4. Right-click an unused printer and select **Properties**.
 5. Click the **Ports** tab.
 6. Click to cancel the **Enable bidirectional support** check box.
 7. Click **OK**.

 This change to the settings disables the bidirectional communication functions of your printer, such as data transfer, status monitoring, and remote panel.

Why doesn't my microphone work?

If you are using an external microphone, make sure the microphone is turned on and is properly plugged into the Microphone jack  on the computer.

Why doesn't my microphone work?

If you are using an external microphone, make sure the microphone is turned on and is properly plugged into the Microphone jack  on the computer.



What do I do if the computer doesn't recognize the mouse?

- Make sure the mouse is securely plugged into the port.
- Restart the computer with the mouse connected to the computer.
- If you are using a wireless mouse, the batteries may need to be replaced.

What do I do if the computer doesn't recognize the mouse?

- Make sure the mouse is securely plugged into the port.
- Restart the computer with the mouse connected to the computer.
- If you are using a wireless mouse, the batteries may need to be replaced.

What do I do if the pointer doesn't move when I use the mouse?

- Make sure another mouse is not installed.
- If you are playing a disc, press the **Ctrl+Alt+Delete** keys simultaneously to stop playback and restart the computer.
- If you still cannot use the pointer, restart the computer. You can restart the computer three different ways:
 - Press the **Windows** key  , and press **U**. When the **Turn Off Computer** window appears, press **R**.
 - Press the **Ctrl+Alt+Delete** keys simultaneously. When the **Windows Task Manager** window appears, press the **Alt** key to highlight the menu bar, and press the **Right Arrow** key  to select **Shut Down**. Press **Enter**, and then press **R**.
 - Press and hold the power button. When the computer turns off, press the power button again to restart the computer.

If you are using a wireless optical mouse:

- Confirm that the supplied AA batteries are properly installed.
- Press the **CONNECT** button on the mouse and the computer to reestablish the connection between the two devices.
- Verify the infrared receiver on the computer's front panel is free of obstructions that may prevent proper operation.
- Avoid using radio-controlled toys or equipment, CB radios, and other wireless devices in the area near your wireless mouse. These devices may cause interference, causing your mouse to stop working properly.
- Do not place metal furniture near your computer or wireless mouse, as this may create interference, causing your mouse to stop working properly.

Why won't my speakers work?

- Make sure the speakers are properly connected and the volume is turned up loud enough to hear sound.
- Your speakers may not be designed for computer use.
- If the speakers have a mute button, set the button to off.
- If the speakers have a volume control, make sure the volume is turned up loud enough to hear sound.
- If you have connected an audio cable to the Headphones jack, disconnect the cable and use the speaker cable that was supplied with the speakers.
- If you are using battery power, make sure the battery is inserted properly and is charged.
- If the speakers require external power, make sure the speakers are connected to a power source. See the guide that accompanied the speakers for more information.

Why won't my speakers work?

- Make sure the speakers are properly connected and the volume is turned up loud enough to hear sound.
- Your speakers may not be designed for computer use.
- If the speakers have a mute button, set the button to off.
- If the speakers have a volume control, make sure the volume is turned up loud enough to hear sound.
- If you have connected an audio cable to the Headphones jack, disconnect the cable and use the speaker cable that was supplied with the speakers.
- If you are using battery power, make sure the battery is inserted properly and is charged.
- If the speakers require external power, make sure the speakers are connected to a power source. See the guide that accompanied the speakers for more information.

Why can't I hear sound from my speakers?



- If the computer is using battery power, make sure the battery is properly inserted and is charged.
- If you are using a program that has its own volume control, make sure the volume control is properly set. See that program's help guide for more information.
- Your speakers may be set to mute, the volume setting may be too low, or the audio option may be disabled. See [Adjusting the sound](#) and [Enabling the sound](#) for more information.

Why is the sound distorted when using Giga Pocket software?



The Line In sound device may not be muted. Follow these steps:

1. Right-click the **Volume** icon  on the Windows® taskbar, and select **Open Volume Control**. The **Volume Control** window appears.
2. Click to select the **Mute** check box for the Line In device.

What do I do if the touch pad does not work?

- Try restarting your computer. Follow these steps:
 1. Press the **Windows** key .
 2. Press **U**. The **Turn off computer** window opens.
 3. Press **R** to restart the computer.
- If the computer does not restart, follow these steps:
 1. Press the **Ctrl+Alt+Delete** keys simultaneously. The **Windows Task Manager** window appears.
 2. Press and release **Alt** to highlight the menu bar, and press the **Right Arrow** key  to select **Shut Down**.
 3. Press **Enter**.
 4. Press **R** to restart the computer.
- If you still cannot restart your computer, press and hold the power button to turn off the computer.
- If the pointer does not move while playing a disc, press **Ctrl+Alt+Delete** simultaneously to stop playback and restart the computer.
- If you are still experiencing problems, make sure another mouse is not installed.
- You may have disabled the touch pad without connecting a mouse to the computer. See [To enable the touch pad.](#)

What do I do if the touch pad does not work?

- Try restarting your computer. Follow these steps:
 1. Press the **Windows** key .
 2. Press **U**. The **Turn off computer** window opens.
 3. Press **R** to restart the computer.
- If the computer does not restart, follow these steps:
 1. Press the **Ctrl+Alt+Delete** keys simultaneously. The **Windows Task Manager** window appears.
 2. Press and release **Alt** to highlight the menu bar, and press the **Right Arrow** key  to select **Shut Down**.
 3. Press **Enter**.
 4. Press **R** to restart the computer.
- If you still cannot restart your computer, press and hold the power button to turn off the computer.
- If the pointer does not move while playing a disc, press **Ctrl+Alt+Delete** simultaneously to stop playback and restart the computer.
- If you are still experiencing problems, make sure another mouse is not installed.
- You may have disabled the touch pad without connecting a mouse to the computer. See [To enable the touch pad.](#)

How do I change the left and right button assignments?

If your computer is interpreting a single-click as a double-click, you may want to change the button assignments. Follow these steps:

1. Click **Start** on the Windows® taskbar and click **Control Panel**, and then click **Printers and Other Hardware** and **Mouse**. The **Mouse Properties** dialog box appears with the **Buttons** tab selected.
2. Select your preferences in the **Button Selection** box, and then click **Apply** to install your settings.

 You may need to use the **Tab** key and the **Up Arrow**  and **Down Arrow**  keys to make your selections.



3. Click **OK** to close the window.

If your computer is interpreting a single-click as a double-click, you may want to change the button assignments. Follow these steps:

1. Click **Start** on the Windows® taskbar and click **Control Panel** and **Printers and Other Hardware** and **Mouse**. The **Mouse Properties** dialog box appears.
2. On the **Buttons** tab, select your preferences in the **Button Selection** box.
3. Click **Apply** to install your settings.
4. Click **OK** to close the window.



Why doesn't the Safely Remove Hardware icon appear on the taskbar when the drive is connected?

The computer does not recognize the floppy disk drive. First, make sure the USB cable is properly connected to the USB port. If you need to secure the connection, wait a few moments for the computer to recognize the drive. If the icon still does not appear, follow these steps:

1. Close all programs that were accessing the floppy disk drive.
2. Wait for the LED indicator on the floppy disk drive to turn off.
3. Push the Eject button, and remove the disk.
4. Reconnect the floppy disk drive by inserting the USB connector (with the USB icon  facing upward) into the USB port .
5. Restart the computer by clicking **Start** on the Windows® taskbar, **Turn Off Computer**, and then **Restart**.

Why doesn't the Safely Remove Hardware icon appear on the taskbar when the drive is connected?

The computer does not recognize the floppy disk drive. First, make sure the USB cable is properly connected to the USB port. If you need to secure the connection, wait a few moments for the computer to recognize the drive. If the icon still does not appear, follow these steps:

1. Close all programs that were accessing the floppy disk drive.
2. Wait for the LED indicator on the floppy disk drive to turn off.
3. Push the Eject button, and remove the disk.
4. Reconnect the floppy disk drive by inserting the USB connector (with the USB icon  facing upward) into the USB port .
5. Restart the computer by clicking **Start** on the Windows® taskbar, **Turn Off Computer**, and then **Restart**.

Why is the drive unable to write data to a floppy disk?

Make sure the floppy disk is properly inserted in the drive. See [Inserting and removing floppy disks](#) for instructions on how to insert the disk properly.

If the disk is inserted properly and you are still unable to write data to it, the disk may be full or write-protected. You can either use a floppy disk that is not write-protected or disable the write-protect feature.

Why doesn't my PC Card work?

- Make sure the PC Card is inserted properly. See [Inserting PC Cards](#) for more information.
- Make sure the PC Card is compatible with the Microsoft® Windows® operating system installed on your computer.
- Use the Sony Notebook Setup utility to disable devices you are not currently using. See [To open Sony Notebook Setup](#) for more information.
- See the instructions that accompanied your PC Card. You may need to install driver software if you are not using a Sony PC Card.

Why doesn't my PC Card work?

- Make sure the PC Card is inserted properly. See [Inserting PC Cards](#) for more information.
- Make sure the PC Card is compatible with the Microsoft® Windows® operating system installed on your computer.
- Use the Sony Notebook Setup utility to disable devices you are not currently using. See [To open Sony Notebook Setup](#) for more information.
- See the instructions that accompanied your PC Card. You may need to install driver software if you are not using a Sony PC Card.

Why doesn't my computer recognize attached devices?

For some PC Cards, if you alternate between normal power operation and the Standby or Hibernate modes while the card is inserted into the PC Card slot, the computer may not recognize the PC Card or the connected device. Restart your computer.

Why can't I insert my PC Card?

- Make sure you are inserting the card correctly. See [Inserting PC Cards](#) for more information.
- You may not be able to use some PC Cards or some functions of the PC Card with this computer. Check the guide that accompanied your PC Card for more information on its use.

Why can't I use the DV recorder?

You may not be able to use the DV recorder, and the message **DV equipment seems to be disconnected or turned off** may appear because the i.LINK[®] cable is not securely plugged into the ports on the computer or camera. Unplug the connectors, and plug them in again. See [Connecting an i.LINK digital video recorder](#) for more information.

¹ i.LINK is a trademark of Sony used only to designate that a product contains an IEEE 1394 connection. The i.LINK connection may vary, depending on the software applications, operating system, and compatible i.LINK devices. All products with an i.LINK connection may not communicate with each other. Refer to the documentation that came with your compatible i.LINK device for information on operating conditions and proper connection. Before connecting compatible i.LINK PC peripherals to your system, such as CD-RW or hard disk drive, confirm their operating system compatibility and required operating conditions.

Why can't I use the DV recorder?

You may not be able to use the DV recorder, and the message **DV equipment seems to be disconnected or turned off** may appear because the i.LINK[®] cable is not securely plugged into the ports on the computer or camera. Unplug the connectors, and plug them in again. See [Connecting an i.LINK digital video recorder](#) for more information.

¹ i.LINK is a trademark of Sony used only to designate that a product contains an IEEE 1394 connection. The i.LINK connection may vary, depending on the software applications, operating system, and compatible i.LINK devices. All products with an i.LINK connection may not communicate with each other. Refer to the documentation that came with your compatible i.LINK device for information on operating conditions and proper connection. Before connecting compatible i.LINK PC peripherals to your system, such as CD-RW or hard disk drive, confirm their operating system compatibility and required operating conditions.

Why can't I see an image or an image that is displayed properly when I am using a VCR?

Some images from an externally-connected video player device or a video game console, may not display or are not displayed correctly. These images include:

- Images from a playback screen that is in pause mode.
- Menu screens of the connected video player device.
- The end of the film roll being played back using the scroll bar.
- Video output from a video game console.
- Video output from a VCR, using a coaxial cable.

Giga Pocket® software cannot record or display all video images from this source.

Why can't I see an image or an image that is displayed properly when I am using a VCR?

Some images from an externally-connected video player device or a video game console, may not display or are not displayed correctly. These images include:

- Images from a playback screen that is in pause mode.
- Menu screens of the connected video player device.
- The end of the film roll being played back using the scroll bar.
- Video output from a video game console.
- Video output from a VCR, using a coaxial cable.

Giga Pocket® software cannot record or display all video images from this source.

Why does my Giga Pocket viewing window or the images played back from a Video Capsule, appear distorted or corrupted?

There are some situations where screen or image distortion may occur, such as:

- When you change the channel on the video player device.
- If there is a damaged section on your video tape.

When using Giga Pocket Personal Video Recorder, set your display settings as follows:

- **Colors** — Use the default factory settings (32-bit).
- **Screen area** — Set your video resolution to the default factory setting.

For PCV-W series models

Do not change the default factory settings for color or the screen area. If you use different settings, you may experience poor image quality.

Why does my system seem to slow down when I play a Video Capsule?

Your computer may respond slower if you try to play back a Video Capsule while recording a TV program with Giga Pocket software. During a timer recording, Giga Pocket software may interrupt or stop your Video Capsule playback to prioritize your computer's resources for the timer recording. If this occurs, wait until the timer recording session has completed, and then play back the Video Capsule.

Why did I get the error message, "Event buffer of audio overflow?"

The timer recording may fail in certain situations, such as:

- The coaxial cable (input) is disconnected after recording has started.
- The TV channel has lost broadcast signal during the recording session.
- Video content being recorded has poor signal quality.

Why did my on-screen display shift or split?

Your on-screen display may shift or split in rare instances. If this should occur, switch the TV/Recording deck and the playback deck, or try switching the channel. Your timer recording continues even if the on-screen display has shifted or split.

Why can't I create new Video Capsules?

You cannot create new Video Capsules when the remaining free space on your hard disk drive reaches approximately 100 MB. Delete any unnecessary Video Capsules or files to increase the free space on your hard drive.

Why can't I open my image files?

You may need to reformat your Memory Stick® media.

 **Formatting Memory Stick media erases all data, including music data, previously saved to it. Before you reformat Memory Stick media, back up important data and confirm that the media does not contain files you want to keep.**

1. Copy the data from the Memory Stick media onto your computer's hard disk to save data or images.
2. Format the Memory Stick media using Memory Stick Formatter software preinstalled on your computer. For instructions about formatting a Memory Stick media, see [Formatting Memory Stick media](#).

Why can't I open my image files?

You may need to reformat your Memory Stick® media.

 **Formatting Memory Stick media erases all data, including music data, previously saved to it. Before you reformat Memory Stick media, back up important data and confirm that the media does not contain files you want to keep.**

1. Copy the data from the Memory Stick media onto your computer's hard disk to save data or images.
2. Format the Memory Stick media using Memory Stick Formatter software preinstalled on your computer. For instructions about formatting a Memory Stick media, see [Formatting Memory Stick media](#).

Why can't I save music files onto my Memory Stick media?

- Copyright protected music cannot be checked out to any Memory Stick media other than MagicGate Memory Stick media.
- Using recorded music requires permission of the copyright holders.
- Sony is not responsible for music files that cannot be recorded from a CD or downloaded from other sources.

Can I copy images from a digital video camera using Memory Stick media?

Yes, and you can view video clips that you have recorded with Memory Stick media-compatible video camera recorders.

How do I prevent damage to the Memory Stick media?

- Do not use the media in locations that are subject to static electricity or electrical noise.
- Do not touch the media connector with your finger or metallic objects.
- Do not attach labels other than the supplied label to a media.
- Do not bend, drop, or apply strong shock to the media.
- Do not disassemble or modify the media.
- Do not allow the media to get wet.

How do I extend the life of the Memory Stick media?

- Use the supplied storage case. See the instructions that came with your media for more information on its use.
- Do not use or store the media in a location that is subject to:
 - Extremely high temperatures, such as in a car parked in the sun
 - Direct sunlight
 - High humidity or places with corrosive substances

Support Options

The section contains information on where to go for answers to questions about your VAIO® computer and the preinstalled software.

- [Sony Support Information](#)
- [Program Support Information](#)

Refer to the following sources for answers in the sequence listed below.

1 **VAIO® Computer User Guide**

The on-screen VAIO® Computer User Guide provides detailed information on how to maximize your computer capabilities and solve common problems.

2 **Program Guides and Help Files**

The preinstalled programs on your computer may come with individual help guides. These guides are stored on the hard disk as on-screen Help files. You can find the Help files from the Help menu under the specific program.

3 **Operating System Online Support**

Your computer comes preinstalled with a Microsoft® Windows® operating system. For operating system support, you can visit Microsoft® customer support at: <http://support.microsoft.com/directory/>.

4 **Sony Computing Support**

This service provides instant access to information on commonly encountered problems. Type a description of the problem and the Knowledge Database searches for the corresponding solutions online. You can visit Sony Computing Support at: <http://www.sony.com/pcsupport>.

5 **VAIO Update**

When your computer is connected to the Internet, VAIO Update automatically notifies you when critical software and security information is posted on the support Web site. Click the VAIO Update notice to open the VAIO Support Web site and view the information. You can also right-click the **VAIO Update** icon  in the **Taskbar Notification** area and select **Go to VAIO Web Support** to open the support Web site.

Program Support Information

Depending on the configuration you purchased, your computer may not include all of the software programs listed below.

Adobe® Photoshop® Elements, Photoshop® Album, Premiere®, Reader® *Adobe Systems Inc.*

Web site <http://www.adobe.com>

Telephone 800-685-3652

America Online® (Broadband or Dial-Up) *AOL, Inc.*

Web site <http://www.aol.com>

AOL® Instant Messenger *AOL, Inc.*

Web site <http://www.aim.com>

Click to DVD *Sony Electronics Inc.*

At the touch of a button, Click to DVD software allows you to automatically burn DVDs from a digital video (DV) device. Create DVDs by capturing video content straight from a DV device or by importing video from stored files — and you can also edit the video. Create DVD photo albums and slide shows with picture files or by importing pictures from a digital still camera. What's more, you can easily give a professional look to your DVDs by adding chapter menus, backgrounds, and menu screens. You are only a few clicks away from your own DVDs!

Web site <http://www.sony.com/pcsupport>

Telephone 888-4-SONY-PC (888-476-6972)

CLiÉ Converter *Sony Electronics Inc.*

CLiÉ Converter software is a plug-in program that converts Giga Pocket® Video Capsules into Movie Player format for playback on your Sony® CLiÉ® handheld. After converting your Video Capsules, you can use CLiÉ Converter software to transfer them to Memory Stick® media or to save them to your hard disk drive for transfer to your CLiÉ handheld during your next HotSync® operation.

Web site <http://www.sony.com/pcsupport>

Telephone 888-4-SONY-PC (888-476-6972)

Drag'n Drop CD+DVD *DigiOn, Inc., and Easy Systems Japan Ltd.*

Web site <http://www.ddcd.jp/dd3e/sony/cd>

DVgate Plus *Sony Electronics Inc.*

Connect a compatible digital video camera to your computer's i.LINK® port and capture video clips and still images. Edit clips from your video, add new clips, and combine clips into new movie segments. Save your movies back to your digital video camera or in a variety of popular file formats.

Web site <http://www.sony.com/pcsupport>

Telephone 888-4-SONY-PC (888-476-6972)

Giga Pocket® Personal Video Recorder

Sony Electronics Inc.

Giga Pocket® Personal Video Recorder is a unique set of hardware and software components that provide you with excellent TV viewing, recording, and playback experiences. You can watch and record your favorite TV programs from your computer, create custom playlists, and play your Video Capsules on other compatible computers. Giga Pocket® Personal Video Recorder enables your computer, TV, VCR, and other video player devices to work in harmony.

Web site <http://www.sony.com/pcsupport>

Telephone 888-4-SONY-PC (888-476-6972)

Google Toolbar

Google, Inc.

Web site <http://toolbar.google.com/help.html>

ImageStation®

Sony Electronics, Inc.

With ImageStation® online service, you can store, organize, and share your photos and video clips online. ImageStation online service membership is free (except for transactions) and includes unlimited storage of digital photos, storage for 15 minutes of video clips, tools to personalize the design and arrangement of your pictures in albums, and access to stories and tips about image handling in ImageStation Magazine.

Web site <http://www.sony.com/pcsupport>

Telephone 888-4-SONY-PC (888-476-6972)

Microsoft® Office Basic Edition, Office Professional Edition, Office Small Business Edition, Office Small Business Edition Trial Version, Office Student and Teacher Edition Trial Version

Microsoft Corp.

Web site <http://www.sony.com/pcsupport>

Telephone 888-4-SONY-PC (888-476-6972)

Microsoft® Internet Explorer, Movie Maker, Media® Player, Works

Microsoft Corp.

Web site <http://www.support.microsoft.com>

MoodLogic

MoodLogic, Inc.

Web site <http://www.moodlogic.com/support>

E-mail help@moodlogic.com

Netscape® Internet Service

AOL Inc.

Web site <http://isp.netscape.com/help/>

Telephone 866-541-8233

Network Smart Capture

Sony Electronics Inc.

Network Smart Capture captures images and video from any Sony® Digital Camcorder that supports a standard i.LINK® connection. Send your video or still images through e-mail or upload them to the ImageStation® service. You can use the Web camera function to automatically upload your captured images.

Web site <http://www.sony.com/pcsupport>

Telephone 888-4-SONY-PC (888-476-6972)

Norton Internet Security
Symantec Corporation

Web site <http://www.symantec.com/techsupp>

PictureGear Studio
Sony Electronics Inc.

PictureGear Studio still image management software displays still images from your hard drive or a Sony digital still camera. The still images appear in a convenient light-table format so that you can easily view the contents of an entire folder, create your own photo albums, and make prints.

Web site <http://www.sony.com/pcsupport>

Telephone 888-4-SONY-PC (888-476-6972)

Quicken® New User Edition
Intuit Inc.

Web site <http://www.intuit.com/support>

Telephone 800-644-3193

SonicStage®
Sony Electronics Inc.

The SonicStage jukebox software program gives you all the tools you need to manage music on your computer. SonicStage software sports high-quality digital audio storage, a sleek player skin design, and audio CD burning capability.

Web site <http://www.sony.com/pcsupport>

Telephone 888-4-SONY-PC (888-476-6972)

SonicStage Mastering Studio
Sony Electronics Inc.

Use SonicStage Mastering Studio software to record songs from analog records or cassette tapes into your computer and output them to CD-R or CD-RW discs or audio files in WAV format.

Web site <http://www.sony.com/pcsupport>

Telephone 888-4-SONY-PC (888-476-6972)

Sony® VAIO® Product Registration
Sony Electronics Inc.

VAIO Product Registration is an integrated registration program for both Sony Electronics and Microsoft Corporation. By registering with Sony, you enable Sony to notify you of software and hardware issues that may affect your user experience. Microsoft directs the data to Sony Electronics. Sony uses the registration data for warranty and product support purposes and the analysis of customer feedback on Sony computer features.

Web site <http://www.sony.com/pcsupport>

Telephone 888-4-SONY-PC (888-476-6972)

TurboTax® for the Web

Intuit, Inc.

Web site <http://www.intuit.com/support>

VAIO Action Setup

Sony Electronics Inc.

VAIO Action Setup manages the settings for your computer's shortcut keys.

Web site <http://www.sony.com/pcsupport>

Telephone 888-4-SONY-PC (888-476-6972)

VAIO Edit Components

Sony Electronics Inc.

VAIO Edit Components is a software plug-in for Adobe® Premiere® software that provides maximum compatibility and video quality for capturing video from your Sony digital camcorder.

Web site <http://www.sony.com/pcsupport>

Telephone 888-4-SONY-PC (888-476-6972)

VAIO Media

Sony Electronics Inc.

VAIO Media software brings multimedia to your network, enabling you to share music, video, and still image files between your VAIO® computers. You can set up one or more computers as "media servers," which store your multimedia files and make them available to other compatible VAIO computers on your wired or wireless network.

Web site <http://www.sony.com/pcsupport>

Telephone 888-4-SONY-PC (888-476-6972)

VAIO Update

Sony Electronics Inc.

The VAIO Update utility helps you keep your VAIO® computer up to date by regularly checking the Sony Online Support Web site for important software updates and information for your specific VAIO computer model.

Web site <http://www.sony.com/pcsupport>

Telephone 888-4-SONY-PC (888-476-6972)

WinDVD® for VAIO®

InterVideo, Inc.

Web site <http://www.intervideo.com/jsp/Support.jsp>

Telephone 510-651-0888

Notice

© 2004 Sony Electronics Inc. Reproduction in whole or in part without written permission is prohibited. All rights reserved. This manual and the software described herein, in whole or in part, may not be reproduced, translated, or reduced to any machine-readable form without prior written approval.

SONY CANNOT WARRANT THAT THE FUNCTIONS DESCRIBED IN THIS GUIDE WILL BE UNINTERRUPTED OR ERROR-FREE. SONY ALSO ASSUMES NO RESPONSIBILITY, AND SHALL NOT BE LIABLE FOR ANY DAMAGES TO, OR VIRUSES THAT MAY INFECT, YOUR COMPUTER EQUIPMENT, OR OTHER PROPERTY ON ACCOUNT OF YOUR ACCESS TO, USE OF, OR BROWSING IN ANY DESCRIBED WEB SITE, OR YOUR DOWNLOADING OF ANY MATERIALS, DATA, TEXT, IMAGES, VIDEO, OR AUDIO FROM ANY DESCRIBED WEB SITE. WEB SITE INFORMATION IS OBTAINED FROM VARIOUS SOURCES AND MAY BE INACCURATE. COPIES OF COPYRIGHTED INFORMATION MAY ONLY BE MADE FOR LEGALLY PERMISSIBLE PURPOSES.

Important information for Canadian customers: Your new VAIO computer includes certain software versions or upgrades, and Internet services or offers that are available to U.S. customers only.

Sony, Click to DVD, DVgate Plus, Memory Stick, Memory Stick Duo, Memory Stick PRO, the Memory Stick logo, OpenMG, SonicStage, i.LINK, CLIE, MagicGate, Giga Pocket, PicoPlayer, VAIO Media, and VAIO are trademarks or registered trademarks of Sony.

All other trademarks are trademarks or registered trademarks of their respective owners.

Notice

© 2004 Sony Electronics Inc. Reproduction in whole or in part without written permission is prohibited. All rights reserved. This manual and the software described herein, in whole or in part, may not be reproduced, translated, or reduced to any machine-readable form without prior written approval.

SONY CANNOT WARRANT THAT THE FUNCTIONS DESCRIBED IN THIS GUIDE WILL BE UNINTERRUPTED OR ERROR-FREE. SONY ALSO ASSUMES NO RESPONSIBILITY, AND SHALL NOT BE LIABLE FOR ANY DAMAGES TO, OR VIRUSES THAT MAY INFECT, YOUR COMPUTER EQUIPMENT, OR OTHER PROPERTY ON ACCOUNT OF YOUR ACCESS TO, USE OF, OR BROWSING IN ANY DESCRIBED WEB SITE, OR YOUR DOWNLOADING OF ANY MATERIALS, DATA, TEXT, IMAGES, VIDEO, OR AUDIO FROM ANY DESCRIBED WEB SITE. WEB SITE INFORMATION IS OBTAINED FROM VARIOUS SOURCES AND MAY BE INACCURATE. COPIES OF COPYRIGHTED INFORMATION MAY ONLY BE MADE FOR LEGALLY PERMISSIBLE PURPOSES.

Important information for Canadian customers: Your new VAIO computer includes certain software versions or upgrades, and Internet services or offers that are available to U.S. customers only.

Sony, Click to DVD, DVgate Plus, Memory Stick, Memory Stick Duo, Memory Stick PRO, the Memory Stick logo, OpenMG, SonicStage, i.LINK, CLIE, MagicGate, Giga Pocket, PicoPlayer, VAIO Media, and VAIO are trademarks or registered trademarks of Sony.

All other trademarks are trademarks or registered trademarks of their respective owners.

END-USER LICENSE AGREEMENT FOR SONY AND CERTAIN THIRD PARTY SOFTWARE

IMPORTANT-READ CAREFULLY: YOUR USE OF YOUR COMPUTER'S SOFTWARE CONSTITUTES AGREEMENT TO THIS LICENSE.

This End-User License Agreement ("License") is a legal agreement between you and Sony Electronics Inc. ("SONY"), the manufacturer of your computer system ("COMPUTER"). All Sony software and third party software (other than software provided by Microsoft Corporation or otherwise subject to its own separate license) included with your COMPUTER, downloaded from Web sites or provided as updates/upgrades as well as related services shall be referred to herein as the SOFTWARE. This License covers only the SOFTWARE. The SOFTWARE includes computer software, the associated media, any printed materials, and any "on-line" or electronic documentation, as well as Sony-supplied or authorized updates/upgrades thereto. All software provided by Microsoft Corporation is covered by a separate End User License Agreement, as may be selected other third party software (in which case you will be informed of such fact). You may use the SOFTWARE only in connection with the use of the COMPUTER. By installing, copying, downloading or otherwise using the SOFTWARE, you agree to be bound by the terms of this License. If you do not agree to the terms of this License, SONY is unwilling to license the SOFTWARE to you. In such event, you may not use or copy the SOFTWARE, and you should promptly contact SONY for instructions on return of the entire COMPUTER and included SOFTWARE for a refund of the purchase price of the COMPUTER.

SOFTWARE LICENSE

The SOFTWARE is protected by copyright laws and international copyright treaties, as well as other intellectual property laws and treaties. The SOFTWARE is licensed, not sold.

GRANT OF LICENSE

This License grants you the following rights:

- **Software** — You may install and use one copy of the SOFTWARE on the COMPUTER.
- **Storage/Network Use** — You may not use the SOFTWARE over a network or distribute the SOFTWARE to other computers over a network except as specifically described in documentation provided with the SOFTWARE.
- **Back-up Copy** — A back-up copy of the SOFTWARE is included with the COMPUTER. You may use the back-up copy solely for recovery purposes.

DESCRIPTION OF OTHER RIGHTS AND LIMITATIONS

- **Limitation on Reverse Engineering, Decompilation and Disassembly** — You may not modify, reverse engineer, decompile, or disassemble the SOFTWARE in whole or in part.
- **Separation of Components** — The SOFTWARE is licensed as a single product. Its component parts may not be separated for use on more than one computer.
- **Single COMPUTER** — The SOFTWARE is licensed with the COMPUTER as a single integrated product. The SOFTWARE may only be used with the COMPUTER except as specifically described in documentation provided with the SOFTWARE.
- **Rental** — You may not rent or lease the SOFTWARE.
- **Software Transfer** — You may permanently transfer all of your rights under this License only as part of a sale or transfer of the COMPUTER, provided you retain no copies, transfer all of the SOFTWARE (including all copies, component parts, the media and printed materials, all versions and any upgrades of the SOFTWARE and this License), and the recipient agrees to the terms of this License.
- **Termination** — Without prejudice to any other rights, SONY may terminate this License if you fail to comply with the terms and conditions of this License. In such event, you must destroy all copies of the SOFTWARE and all of its component parts.

COPYRIGHT

All title and copyrights in and to the SOFTWARE (including but not limited to any images, photographs, animation, video, audio, music, text and "applets," incorporated into the SOFTWARE), and any copies of the SOFTWARE, are owned by SONY or its suppliers. All rights not specifically granted under this License are reserved by SONY.

USE OF SOFTWARE WITH COPYRIGHTED MATERIALS

The SOFTWARE is capable of being used by you to store, process and use content created by you and third parties. Such content may be protected by copyright, other intellectual property laws, and/or agreements. You agree to use the SOFTWARE only in compliance with all such laws and agreements that apply to such content. You agree that SONY may take appropriate measures to protect copyright of content stored, processed or used by the SOFTWARE. Such measures include, but are not limited to, counting the frequency of your backup and restoration through certain SOFTWARE features, refusal to accept your request to enable restoration of data through certain SOFTWARE features and termination of this License in the event of your illegitimate use of the SOFTWARE.

HIGH RISK ACTIVITIES

The SOFTWARE is not fault-tolerant and is not designed, manufactured or intended for use or resale as on-line control equipment in hazardous environments requiring fail-safe performance, such as in the operation of nuclear facilities, aircraft navigation or communication systems, air traffic control, direct life support machines, or weapons systems, in which the failure of the SOFTWARE could lead directly to death, personal injury, or severe physical or environmental damage ("High Risk Activities"). SONY and its suppliers specifically disclaim any express or implied warranty of fitness for High Risk Activities.

PROHIBITION ON EXPORT. EXCEPT FOR EXPORT TO CANADA FOR USE IN CANADA BY CANADIAN CITIZENS, THE SOFTWARE AND ANY UNDERLYING TECHNOLOGY MAY NOT BE EXPORTED OUTSIDE THE UNITED STATES OR TO ANY FOREIGN ENTITY OR "FOREIGN PERSON" AS DEFINED BY U.S. GOVERNMENT REGULATIONS, INCLUDING WITHOUT LIMITATION, ANYONE WHO IS NOT A CITIZEN, NATIONAL OR LAWFUL PERMANENT RESIDENT OF THE UNITED STATES. BY DOWNLOADING OR USING THE SOFTWARE, YOU ARE AGREEING TO THE FOREGOING AND YOU ARE WARRANTING THAT YOU ARE NOT A "FOREIGN PERSON" OR UNDER THE CONTROL OF A FOREIGN PERSON.

U.S. GOVERNMENT RESTRICTED RIGHTS

THE SOFTWARE PRODUCT and documentation are provided with RESTRICTED RIGHTS. Use, duplication, or disclosure by the United States Government is subject to restrictions as set forth in subparagraph (c)(1) and (2) of the Commercial Computer Software-Restricted Rights at 48 CFR 52.227-19, as applicable. Manufacturer is Sony Electronics Inc., One Sony Drive, Park Ridge, New Jersey 07656.

LIMITED WARRANTY ON CD-ROM MEDIA

SONY warrants that for a period of ninety (90) days from the date of its delivery to you the CD-ROM media on which the back-up copy of the SOFTWARE is furnished to you will be free from defects in materials and workmanship under normal use. This limited warranty extends only to you as the original licensee. SONY's entire liability and your exclusive remedy will be replacement of the CD-ROM media not meeting SONY's limited warranty and which is returned to SONY with proof of purchase in the form of a bill of sale (which is evidence that the CD-ROM media is within the warranty period). SONY will have no responsibility to replace a disk damaged by accident, abuse or misapplication. ANY IMPLIED WARRANTIES ON THE CD-ROM MEDIA, INCLUDING THE IMPLIED WARRANTIES OF MERCHANTABILITY AND FITNESS FOR A PARTICULAR PURPOSE, ARE LIMITED IN DURATION TO NINETY (90) DAYS FROM THE DATE OF DELIVERY. SOME STATES DO NOT ALLOW LIMITATIONS ON HOW LONG AN IMPLIED WARRANTY LASTS, SO THESE LIMITATIONS MAY NOT APPLY TO YOU. THIS WARRANTY GIVES YOU SPECIFIC LEGAL RIGHTS, AND YOU MAY ALSO HAVE OTHER RIGHTS WHICH VARY FROM STATE TO STATE.

EXCLUSION OF WARRANTY ON SOFTWARE

You expressly acknowledge and agree that use of the SOFTWARE is at your sole risk. The SOFTWARE is provided "AS IS" and without warranty of any kind and SONY and SONY's licensors (In this Section, SONY and SONY's licensors shall be collectively referred to as "SONY") EXPRESSLY DISCLAIM ALL WARRANTIES, EXPRESS OR IMPLIED, INCLUDING, BUT NOT LIMITED TO, THE IMPLIED WARRANTIES OF MERCHANTABILITY AND FITNESS FOR A PARTICULAR PURPOSE. SONY DOES NOT WARRANT THAT THE FUNCTIONS CONTAINED IN THE SOFTWARE WILL MEET YOUR REQUIREMENTS, OR THAT THE OPERATION OF THE SOFTWARE WILL BE CORRECTED. FURTHERMORE, SONY DOES NOT WARRANT OR MAKE ANY REPRESENTATIONS REGARDING THE USE OR THE RESULTS OF THE USE OF THE SOFTWARE IN TERMS OF ITS CORRECTNESS, ACCURACY, RELIABILITY, OR OTHERWISE. NO ORAL OR WRITTEN INFORMATION OR ADVICE GIVEN BY SONY OR A SONY AUTHORIZED REPRESENTATIVE SHALL CREATE A WARRANTY OR IN ANY WAY INCREASE THE SCOPE OF THIS WARRANTY. SHOULD THE SOFTWARE PROVE DEFECTIVE, YOU (AND NOT SONY OR A SONY AUTHORIZED REPRESENTATIVE) ASSUME THE ENTIRE COST OF ALL NECESSARY SERVICING, REPAIR OR CORRECTION. SOME JURISDICTIONS DO NOT ALLOW THE EXCLUSION OF IMPLIED WARRANTIES, SO THE ABOVE EXCLUSION MAY NOT APPLY TO YOU.

Without limiting the foregoing, it is specifically provided that SOFTWARE is not designed or intended for use on a computer other than COMPUTER. SONY provides no warranty that any other computer hardware and software will not be damaged by the SOFTWARE or any data you download using the SOFTWARE. You expressly acknowledge and agree that use of

SOFTWARE is at your sole risk and you are responsible for installation of the SOFTWARE and use of the SOFTWARE on your COMPUTER.

LIMITATION OF LIABILITY

IN THIS SECTION, SONY AND SONY'S LICENSOR'S SHALL BE COLLECTIVELY REFERRED TO AS "SONY." SONY SHALL NOT BE LIABLE FOR ANY INCIDENTAL OR CONSEQUENTIAL DAMAGES FOR BREACH OF ANY EXPRESS OR IMPLIED WARRANTY, BREACH OF CONTRACT, NEGLIGENCE, STRICT LIABILITY OR ANY OTHER LEGAL THEORY RELATED TO THIS PRODUCT. SUCH DAMAGES INCLUDE, BUT ARE NOT LIMITED TO, LOSS OF PROFITS, LOSS OF REVENUE, LOSS OF DATA, LOSS OF USE OF THE PRODUCT OR ANY ASSOCIATED EQUIPMENT, DOWN TIME AND PURCHASER'S TIME, EVEN IF SONY HAS BEEN ADVISED OF THE POSSIBILITY OF SUCH DAMAGES. IN ANY CASE, SONY'S ENTIRE LIABILITY UNDER ANY PROVISION OF THIS AGREEMENT SHALL BE LIMITED TO THE AMOUNT ACTUALLY PAID BY YOU ALLOCABLE TO THE SOFTWARE. SOME STATES DO NOT ALLOW THE EXCLUSION OR LIMITATION OF CONSEQUENTIAL OR INCIDENTAL DAMAGES, SO THE ABOVE EXCLUSION OR LIMITATION MAY NOT APPLY TO YOU.

SOFTWARE DATA COLLECTION AND MONITORING

The SOFTWARE contains features which may allow SONY and/or third parties to collect data from, control and/or monitor computers and devices running or interacting with the SOFTWARE. You hereby agree that such activities may occur. SONY's current privacy policy is located at www.sony.com. Please contact applicable third parties for privacy policies related to their software and services.

AUTOMATIC UPDATE FEATURE

From time to time, SONY or third parties may automatically update or otherwise modify the SOFTWARE, for example, but not limited to, for purposes of enhancement of security functions, error correction and improvement of functions, at such time as you interact with SONY's or third parties's servers, or otherwise. Such updates or modifications may delete or change the nature of features or other aspects of the SOFTWARE, including functions you may rely upon. You hereby agree that such activities may occur at SONY's sole discretion and that SONY may condition continued use of the SOFTWARE upon your complete installation or acceptance of such update or modifications.

GOVERNING LAW AND JURISDICTION, JURY TRIAL WAIVER

This agreement shall be governed by the laws of the State of California, United States of America, without regards to conflict of laws provisions. Any dispute arising out of this Agreement shall be subject to the exclusive venue of the state and federal courts of Santa Clara County, California, and the parties hereby consent to the venue and jurisdiction of such courts. THE PARTIES HERETO WAIVE TRIAL BY JURY WITH RESPECT TO ANY MATTERS ARISING UNDER OR RELATING TO THIS AGREEMENT.

SONY RESERVES THE RIGHT TO AMEND THE SPECIFIC TERMS OF THE LICENSE REGARDING THE SOFTWARE AT ITS SOLE DISCRETION BY NOTICE TO YOU AT THE E-MAIL ADDRESS YOU HAVE PROVIDED TO SONY AS PART OF YOUR REGISTRATION, OR ANY OTHER LEGALLY RECOGNIZABLE FORM OF NOTICE. If you do not agree to the terms to be amended, which shall be notified to you by SONY before they take effect, you must return the entire COMPUTER, any other materials bundled in the package at the time of the purchase, together with any software you obtained from Sony Web site for refund pursuant to the terms in the first paragraph of this License, titled "IMPORTANT- READ CAREFULLY". Your continued use of the SOFTWARE after notice shall be deemed agreement to be bound by such amendment.

If any part of this Agreement is held invalid or unenforceable, the other parts will remain valid.

Should you have any questions concerning this license or this limited warranty, you may contact SONY, by writing to SONY at Sony Technical Response Center, 12451 Gateway Boulevard, Fort Myers, Florida 33913.

End-User License Agreement For Sony Software

Giga Pocket software including PicoPlayer® software

CAREFULLY READ THE FOLLOWING AGREEMENT BEFORE USING THIS SOFTWARE. USE OF THIS SOFTWARE INDICATES YOUR ACCEPTANCE OF THE AGREEMENT.

IMPORTANT-READ CAREFULLY:

This End User License Agreement (EULA) is a legal agreement between you and Sony Electronics Inc. (SONY), the manufacturer of your SONY computer system (COMPUTER). Please read this EULA carefully before using Giga Pocket (including PicoPlayer) software and related materials distributed together with this EULA (SONY SOFTWARE). By using the SONY SOFTWARE, you agree to be bound by the terms of this EULA. You may use the SONY SOFTWARE only in connection with the use of COMPUTER. SONY SOFTWARE is licensed not sold.

If you do not agree to the terms of this EULA, SONY is unwilling to license the SONY SOFTWARE to you. In such event, you may not use or copy the SONY SOFTWARE, and you should promptly contact SONY for instructions on return of the entire COMPUTER and included SONY SOFTWARE for a refund of the purchase price of the COMPUTER.

SONY SOFTWARE LICENSE

Copyright laws and international copyright treaties, as well as other intellectual property laws and treaties protect the SONY SOFTWARE.

GRANT OF LICENSE. This License grants you the following rights:

Software.

You may use one copy of the SONY SOFTWARE on the COMPUTER except that you may make multiple copies and distribute the PicoPlayer software to other users that agree to the PicoPlayer license

Back-up Copy.

You may make one back-up copy of SONY SOFTWARE solely for archival purposes.

DESCRIPTION OF REQUIREMENTS, RESTRICTIONS, RIGHTS AND LIMITATIONS

Limitation on Reverse Engineering, Decompilation and Disassembly.

You may not modify, reverse engineer, decompile, or disassemble the SONY SOFTWARE in whole or in part.

Rental.

You may not rent or lease the SONY SOFTWARE.

Software Transfer.

You may permanently transfer all of your rights under this EULA only as part of a sale or transfer of SONY SOFTWARE, provided you retain no copies, transfer all of the SONY SOFTWARE (including all copies, component parts, the media and printed materials, all versions and any upgrades of the SONY SOFTWARE and this EULA), and the recipient agrees to the terms of this EULA.

Termination.

Without prejudice to any other rights, SONY may terminate this EULA if you fail to comply with the terms and conditions of this EULA. In such event, you must destroy all copies of the SONY SOFTWARE and all of its component parts.

Confidentiality.

You agree to keep information contained in SONY SOFTWARE which is not publicly known, confidential to yourself, and not to disclose such information to others without prior written approval from SONY.

COPYRIGHT

All title and copyright in and to the SONY SOFTWARE (including but limited to any images, photographs, animation, video, audio, music, text and "applets", incorporated into the SONY SOFTWARE), and any copies of the SONY SOFTWARE, are owned by SONY or its suppliers. SONY reserves all rights not specifically granted under this EULA.

USE OF SONY SOFTWARE WITH COPYRIGHTED MATERIALS

The SONY SOFTWARE is capable of being used to process, store and share personally created and other content. You agree to use the SONY SOFTWARE only in compliance with all copyright and other laws and agreements that apply to such content.

HIGH RISK ACTIVITIES

The SONY SOFTWARE is not fault-tolerant and is not designed, manufactured or intended for use or resale as on-line control equipment in hazardous environments requiring fail-safe performance, such as in the operation of nuclear facilities, aircraft navigation or communication systems, air traffic control, direct life support machines, or weapons systems, in which the failure of the SONY SOFTWARE could lead to death, personal injury, or severe physical or environmental damage (High Risk Activities). SONY and its suppliers specifically disclaim any express or implied warranty or condition of fitness for High Risk Activities.

PROHIBITION ON EXPORT.

THE SONY SOFTWARE AND ANY UNDERLYING TECHNOLOGY MAY NOT BE EXPORTED OUTSIDE THE UNITED STATES OR TO ANY FOREIGN ENTITY OR "FOREIGN PERSON" AS DEFINED BY U.S. GOVERNMENT REGULATIONS, INCLUDING WITHOUT LIMITATION, ANYONE WHO IS NOT A CITIZEN, NATIONAL OR LAWFUL PERMANENT RESIDENT OF THE UNITED STATES. BY DOWNLOADING OR USING THE SONY SOFTWARE, YOU ARE AGREEING TO THE FOREGOING AND YOU ARE WARRANTING THAT YOU ARE NOT A "FOREIGN PERSON" OR UNDER THE CONTROL OF A FOREIGN PERSON.

U.S. GOVERNMENT RESTRICTED RIGHTS.

(I) THE SOFTWARE PRODUCT and documentation are provided with RESTRICTED RIGHTS. Use, duplication, or disclosure by the United States Government is subject to restrictions as set forth in subparagraph (c)(1) and (2) of the Commercial Computer Software-Restricted Rights at 48 CFR 52.227-19, as applicable. Manufacturer is Sony Electronics Inc., One Sony Drive, Park Ridge, New Jersey 07656. (II) All SONY technical data and computer software is commercial in nature and developed solely at private expense. Software is delivered as Commercial Computer Software as defined in DFARS 252.227-7014 (June 1995) or as a commercial item as defined in FAR 2.101(a) and as such is provided with only such rights as are provided in the SONY standard commercial license for such software. Technical data is provided with limited rights only as provided in DFARS 252.227-7015 (Nov.1995) or FAR 52.227-14 (June 1987), whichever is applicable.

EXCLUSION OF WARRANTY ON SONY SOFTWARE.

You expressly acknowledge and agree that use of the SONY SOFTWARE is at your sole risk. The SONY SOFTWARE is provided "AS IS" and without warranty or CONDITIONS of any kind. SONY and SONY's licensors (hereinafter, SONY and SONY's licensors shall be collectively referred to as "SONY") EXPRESSLY DISCLAIM ALL WARRANTIES AND CONDITIONS, EXPRESS OR IMPLIED, INCLUDING, BUT NOT LIMITED TO, THE IMPLIED WARRANTIES AND CONDITIONS OF MERCHANTABILITY AND FITNESS FOR A PARTICULAR PURPOSE. SONY DOES NOT WARRANT THAT THE FUNCTIONS CONTAINED IN THE SONY SOFTWARE WILL MEET YOUR REQUIREMENTS, OR THAT THE OPERATION OF THE SONY SOFTWARE WILL BE CORRECTED. FURTHERMORE, SONY DOES NOT WARRANT OR MAKE ANY REPRESENTATIONS REGARDING THE USE OR THE RESULTS OF THE USE OF THE SONY SOFTWARE IN TERMS OF ITS CORRECTNESS, ACCURACY, RELIABILITY, OR OTHERWISE. NO ORAL OR WRITTEN INFORMATION OR ADVICE GIVEN BY SONY OR A SONY AUTHORIZED REPRESENTATIVE SHALL CREATE A WARRANTY OR CONDITION OR IN ANY WAY INCREASE THE SCOPE OF THIS WARRANTY. SHOULD THE SONY SOFTWARE PROVE DEFECTIVE, YOU (AND NOT SONY OR A SONY AUTHORIZED REPRESENTATIVE) ASSUME THE ENTIRE COST OF ALL NECESSARY SERVICING, REPAIR OR CORRECTION. SOME JURISDICTIONS DO NOT ALLOW THE EXCLUSION OF IMPLIED WARRANTIES OR CONDITIONS, SO THE ABOVE EXCLUSION MAY NOT APPLY TO YOU.

LIMITATION OF LIABILITY

SONY SHALL NOT BE LIABLE FOR ANY INCIDENTAL, INDIRECT OR CONSEQUENTIAL DAMAGES FOR BREACH OF ANY EXPRESS OR IMPLIED WARRANTY OR CONDITION, BREACH OF CONTRACT, NEGLIGENCE, STRICT LIABILITY OR ANY OTHER LEGAL THEORY RELATED TO THIS PRODUCT AND SONY SOFTWARE. SUCH DAMAGES INCLUDE, BUT ARE NOT LIMITED TO, LOSS OF PROFITS, LOSS OF REVENUE, LOSS OF DATA, LOSS OF USE OF THE PRODUCT OR ANY ASSOCIATED EQUIPMENT, DOWN TIME AND PURCHASER'S TIME, EVEN IF SONY HAS BEEN ADVISED OF THE POSSIBILITY OF SUCH DAMAGES. IN ANY CASE, THE ENTIRE LIABILITY TO SONY, UNDER ANY PROVISION OF THIS AGREEMENT SHALL BE LIMITED TO THE AMOUNT ACTUALLY PAID BY YOU, ALLOCABLE TO THE SONY SOFTWARE. SOME JURISDICTIONS DO NOT ALLOW THE EXCLUSION OR LIMITATION OF CONSEQUENTIAL, INDIRECT OR INCIDENTAL DAMAGES, SO THE ABOVE EXCLUSION OR LIMITATION MAY NOT APPLY TO YOU.

GOVERNING LAW AND JURISDICTION, JURY TRIAL WAIVER

This agreement shall be governed by the laws of the State of California, United States of America, without regards to conflict of laws provisions. Any dispute arising out of this Agreement shall be subject to the exclusive venue of the state and federal courts of Santa Clara County, California, and the parties hereby consent to the venue and jurisdiction of Page 314

courts. THE PARTIES HERETO WAIVE TRIAL BY JURY WITH RESPECT TO ANY MATTERS ARISING UNDER OR RELATING TO THIS AGREEMENT.

If any part of this Agreement is held invalid or unenforceable, the other parts will remain valid.

Should you have any questions concerning this license or this limited warranty, you may contact SONY by writing to SONY at Sony Technical Response Center, 12451 Gateway Boulevard, Fort Myers, Florida 33913.