

EAN:	4013288225283	Size:	405x360x60 mm
Part number:	05150103001	Weight:	1707 g
Article number:	9712	Country of origin:	CZ
		Customs tariff number:	82054000

- High-quality, durable foam insert without chemical vapours
- Durable foam insert, each tool has its own place; two-coloured, missing tools will quickly be noticed
- Optimum fit for the best possible removal of the tools from the foam insert
- Water- and oil-repellent, low maintenance and easy to clean
- Protection of the tool from dirt and impact
- 6 Kraftform Plus screwdrivers with hard zones for high working speeds and soft handle zones for a high torque transfer
- 4 Kraftform Micro screwdrivers with a rotating cap for fast turning
- 4 T-handle screwdrivers for the transmission of particularly high tightening and loosening moments

Durable foam insert; two-coloured for quick identification of missing parts; suitable for the Tool Rebel roller cabinet, equipped with 14 Wera TORX® screwdrivers (workshop, Kraftform Micro and T-handle) with holding function for TORX® screws.



Web link
<https://www.wera.de/en/05150103001>

Wera - 9712
 05150103001 - 4013288225283

Wera Werkzeuge GmbH
 Korzter Straße 21-25
 D-42349 Wuppertal
 Tel: +49 (0)2 02 / 40 45-0
 E-Mail: info@wera.de

Safe storage and quick overview

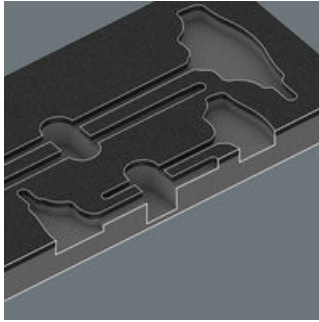

The tools sit securely in the foam thanks to precise contour cutouts, but are easy to remove. The carefully designed arrangement of the tools ensures space-saving storage and quick access to each tool.

Two-coloured foam insert

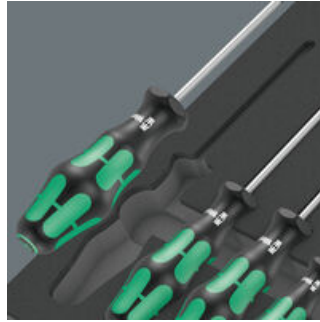

After removing the tool the light grey second foam becomes visible and therefore missing tools are quickly identified.

Holding function for recessed TORX® screws

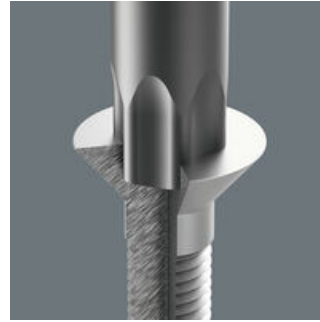

The HF tools developed by Wera are ideal because they feature an optimised geometry of the original TORX® profile. The wedging forces resulting from the surface pressure between the drive tip and the screw profile mean that TORX® screws made according to Camcar Innovations, Michigan, USA specifications are securely held on the tool!

Wera Black Point tip

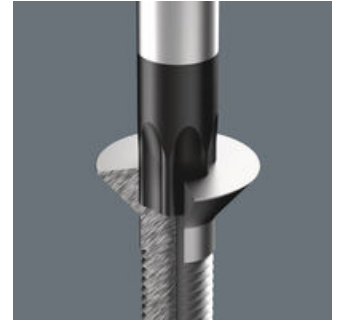

The Wera Black Point tip and a refined hardening process ensure long service life of the tip, improved corrosion protection and an exact fit.

Ergonomic design



The ergonomic design of the T-handle fills the palm of the hand. The fingers rest in the soft, rounded recess, and the whole hand is in contact with the handle - so there is no friction loss between the hand and handle.

Second arm



The additional short arm, which emerges laterally from the handle, allows the transmission of extremely high torques by using the long arm as a lever.

Kraftform Micro screwdrivers

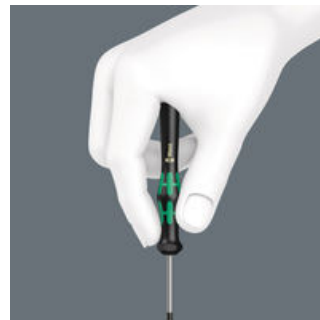

The Kraftform Micro screwdrivers with their power-, fast rotating- and precision zones perfectly meet the requirements for precision mechanical couplings. The smooth-running cap, on which you can rest your hand, ideally supports these advantages.

The precision zone

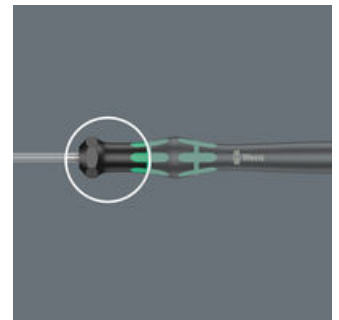

The precision zone directly above the blade gives the user a better feel for the right rotation angle during fine adjustment work.

Web link

<https://www.wera.de/en/05150103001>

Wera - 9712

05150103001 - 4013288225283

Wera Werkzeuge GmbH

Korzter Straße 21-25

D-42349 Wuppertal

Tel: +49 (0)2 02 / 40 45-0

E-Mail: info@wera.de

Set contents:

367 TORX® HF Screwdriver with holding function for TORX® screws, TX 8 x 60 mm



05028048001	1x	TX 8 x 60 mm
05028049001	1x	TX 9 x 60 mm
05028050001	1x	TX 10 x 80 mm
05028051001	1x	TX 15 x 80 mm
05028052001	1x	TX 20 x 100 mm
05028053001	1x	TX 25 x 100 mm

2067 TORX® HF Screwdriver with holding function for electronic applications, TX 4 x 40 mm



05118180001	1x	TX 4 x 40 mm
05118181001	1x	TX 5 x 40 mm
05118182001	1x	TX 6 x 40 mm
05118183001	1x	TX 7 x 60 mm

467 TORX® HF T-handle screwdriver with holding function, TX 20 x 100 mm



05023373001	1x	TX 20 x 100 mm
05023375001	1x	TX 25 x 100 mm
05023378001	1x	TX 30 x 200 mm
05023379001	1x	TX 40 x 200 mm

9812 Foam insert TORX® HF screwdriver set 1, empty, 344 x 30 x 392 mm

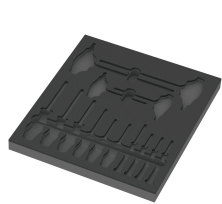

05137312001 ¹⁾	1x	344 x 30 x 392 mm
---------------------------	----	-------------------

1) Attention: The foam insert does not fit in the previous model 05501051001 of the roller cabinet.

Web link

<https://www.wera.de/en/05150103001>

Wera - 9712

05150103001 - 4013288225283

Wera Werkzeuge GmbH

Korzter Straße 21-25

D-42349 Wuppertal

Tel: +49 (0)2 02 / 40 45-0

E-Mail: info@wera.de