



SAFEWAZE

V-Select Hot Work Harness Manual



STANDARDS	
ANSI	Z359.11-2021
OSHA	1926.502, 1910.140

**Read and understand instructions before using equipment!
Do not throw away instructions!**

**Always verify the latest revision of the Safewaze Manual is being utilized.
Visit the Safewaze website, or contact Customer Service, for updated manuals.**

⚠️ IMPORTANT:

- Please refer to this manual for essential instructions on the use, care, or suitability of this equipment for your application. Contact Safewaze for any additional questions.
- Record all important product information prior to use. Documentation of all Competent Person annual inspections is required in the Inspection Log.

▶ USER INFORMATION

Date of First Use: _____

Serial Number: _____

Trainer: _____

User: _____

▶ SAFETY INFORMATION AND PRECAUTIONS

- The manufacturer's instructions must be provided to users of this equipment.
- The user must read, understand, and follow all safety and usage information contained within this manual.
- The user must safely and effectively use the harness and all equipment used in conjunction with the product.
- Failure to follow all safety and usage information can result in serious injury or death.

⚠Warnings:

Regulations included herein are not all-inclusive, are for reference only, and are not intended to replace a Competent Person's judgment or knowledge of federal or state standards.

The warnings indicated below are designed to minimize risk associated with the use of a Safewaze harness.

- Users shall consult with their doctor to verify ability to safely absorb the forces of a fall arrest event. Fitness level, age, and other health conditions can greatly affect an individual's ability to withstand fall arrest forces. Women who are pregnant and individuals considered minors must not use any Safewaze equipment.
- Do not alter or misuse equipment. Only Safewaze, or entities authorized in writing by Safewaze, may make repairs to Safewaze fall protection equipment.
- A Competent Person must conduct an analysis of the workplace and anticipate where workers will be conducting their duties, the route they will take to reach their work, and any existing and potential fall hazards.
- The Competent Person must choose the fall protection equipment to be utilized. Selections must account for all potential hazardous workplace conditions. All fall protection equipment should be purchased in new and unused condition.
- Training of Authorized Persons to correctly install, inspect, disassemble, maintain, store, and use equipment must be provided by a Competent Person. Training must include the ability to recognize fall hazards, minimize the likelihood of fall hazards, and the correct use of personal fall arrest systems.
- Equipment that is exposed to fall arrest forces must be immediately removed from service and destroyed.
- Equipment designated for fall protection must never be used to lift, hang, support, or hoist tools or equipment unless specifically certified for such use.
- Use of a body belt is not authorized for fall arrest applications.
- Work directly under the anchor point as much as possible to minimize swing fall hazards.
- The user must ensure that there is adequate fall clearance when working at height.
- Avoid using the product in applications where engulfment hazards exist.
- If work is conducted in a high heat environment, ensure that Arc Flash or other suitable fall protection equipment is utilized.
- Avoid moving machinery, sharp and/or abrasive edges, and any other hazard that could damage or degrade the component.
- Utilize extra caution to keep lifeline free from any obstructions including, but not limited to, surrounding objects, tools, equipment, moving machinery, co-workers, yourself, or possible impact from overhead objects.
- D-ring extenders must be factored into fall clearance calculations if present on the harness.

TABLE OF CONTENTS

1.0	▶ Introduction	5
2.0	▶ Intended Use	5
3.0	▶ Applicable Safety Standards	5
4.0	▶ Worker Classifications	5
5.0	▶ Rescue Plan	6
6.0	▶ Product Limitations	6
7.0	▶ Allowed Anchorage Applications	7
8.0	▶ Product Specifications	8
9.0	▶ Fall Clearance	8
10.0	▶ Compatibility of Connectors	11
11.0	▶ Making Connections	11
12.0	▶ Harness Sizing/Pre-Inspection	12
13.0	▶ Putting On And Adjusting Harness	13
14.0	▶ Buckle Types and Operation	14
15.0	▶ Torso Adjusters and Operation	16
16.0	▶ SRL Connection Point	17
17.0	▶ Lanyard Keepers	17
18.0	▶ Harness Connection Examples	18
19.0	▶ Inspection and Maintenance	18
20.0	▶ Labels	22
21.0	▶ Part Numbers Covered	22
22.0	▶ ANSI/ASSP Z359.11, ANNEX A	23
23.0	▶ Harness Inspection Checklist	26
24.0	▶ Annual Inspection Form	27

► 1.0 INTRODUCTION

Thank you for purchasing a Safewaze V-Select Hot Work Harness. These harnesses are constructed from heat-resistant materials to protect the harness from heat, burns, splatters, frays, slag, etc. in welding, grinding, cutting, and other harsh high heat at height work applications. A harness is designed to be used as part of a complete personal fall arrest system (PFAS). The harness is the bodywear component of the PFAS, provides an attachment point for a worker's connecting device, and safely distributes fall arrest forces over the user's body in the event of a fall.

The Safewaze V-Select Hot Work Harness is available in a variety of configurations and sizes. Model numbers included in this series can be found on p. 22. This manual must be read and understood in its entirety and used as part of an employee training program as required by OSHA or any applicable state agency.

► 2.0 INTENDED USE

The equipment covered in this manual is intended for use as part of a complete personal fall protection system. Use of this equipment for any other purpose including, but not limited to, sports or recreational activities, non-approved material handling applications, or other action not described in these instructions, is not approved by Safewaze. Use of this equipment in a manner outside the scope of those covered within this manual can result in serious injury or death. The equipment covered in this manual must only be used by trained personnel in workplace applications. If the harness is used for training, a secondary fall protection system must be used so the trainee is not exposed to accidental fall hazards.

► 3.0 APPLICABLE SAFETY STANDARDS

When used according to instructions, this product meets **ANSI Z359.11-2021** standard and **OSHA 1926.502** and **1910.140** regulations. Applicable standards and regulations depend on the type of work being done and may include state-specific regulations. Refer to local, state, and federal requirements for additional information on the governing of occupational safety regarding Personal Fall Arrest Systems (PFAS).

► 4.0 WORKER CLASSIFICATIONS

Read and understand the definitions of those who work in proximity of, or may be exposed to, fall hazards:

Qualified Engineer: A person with a Bachelor of Science in Engineering degree from an accredited college or university. They are able to assume personal responsibility for the development and application of engineering science and knowledge in the design, construction, use, and maintenance of their projects.

Qualified Person: One who, by possession of a recognized degree, certificate, or professional standing, or who by extensive knowledge, training, and experience, has successfully demonstrated their ability to solve or resolve problems relating to the subject matter, the work, or the project.

Competent Person: One who is capable of identifying existing and predictable hazards in the surroundings or working conditions which are unsanitary, hazardous, or dangerous to employees, and who has authorization to take prompt corrective measures to eliminate them.

Authorized Person: A person approved or assigned by the employer to perform a specific type of duty or duties, or to be at a specific location or locations, at the jobsite.

It is the responsibility of a Qualified Person or Engineer to supervise the jobsite and ensure safety regulations are met.

► 5.0 RESCUE PLAN

Prior to the use of this equipment, employers must create a rescue plan in the event of a fall and provide the means to implement the plan through training. The rescue plan must be specific to the project. The rescue plan must allow for employees to rescue themselves or be promptly rescued by alternative means.

This plan must be communicated to/understood by all equipment users, authorized persons, and rescuers. Rescue operations may require specialized equipment beyond the scope of this manual. Every user must be trained in the inspection, installation, operation, and proper usage of their Rescue Equipment and Rescue Plan. See ANSI Z359.4-2013 for specific rescue information. Immediately seek medical attention in the event a worker suffers a fall arrest incident.

Note: Special rescue measures may be required for a fall over an edge.

► 6.0 PRODUCT LIMITATIONS

When installing or using this equipment always refer to the following requirements and limitations:

- **Capacity Range:** ANSI 130-310 lbs. (59-141 kg) and OSHA up to 420 lbs. (191 kg). *including clothing, tools, equipment, etc.
- **Anchorage:** Anchorages selected for fall arrest systems shall have a strength capable of sustaining static loads applied in the directions permitted by the system of at least:
 1. 5,000 lbs. (2267.9 kg) for non-certified anchorages, or
 2. Two times the maximum arresting force for certified anchorages.

Note: When more than one fall arrest system is attached to an anchorage, the strengths set forth in one of the above shall be multiplied by the number of systems attached to the anchorage.

From OSHA 1926.502 and 1910.66: Anchorages used for attachment of personal fall arrest systems shall be independent of any anchorage being used to support or suspend platforms and capable of supporting at least 5,000 lbs. (2267.9 kg) per user attached. Or, anchorages for attachment shall be designed, installed, and used as part of a complete PFAS which maintains a safety factor of at least two and is under the supervision of a Qualified Person.

- **Locking Speed:** The nature of an SRL requires a clear fall path to ensure the SRL will lock in the event of a fall. Working in obstructed fall paths, cramped areas, or on moving materials like sand and grain, may not allow the user's body to gain enough speed buildup to cause the SRL to engage and lock in the event of a fall.

- **Free Fall:** The distance a user falls before the fall arrester activates.
- **Swing Falls:** As the user moves laterally away from an overhead anchor point, the risks related to swing falls increase. The force of striking an object involving swing fall can in some instances generate more forces than a fall with the user wearing no fall protection equipment. Minimize swing falls by working as directly below the anchorage point as possible.
- **Swing Fall Drop Distance:** The additional clearance added from excess cable being paid out when working at a lateral offset from the anchorage.
- **Fall Clearance:** The amount of feet required below the working surface for the personal fall arrest system to work correctly.
- **Hazards:** Extra precautions should be taken if this equipment is used in an environment where hazards exist. Hazards can include, but are not limited to, moving machinery, high voltage equipment or power lines, caustic chemicals, corrosive environments, toxic or explosive gases, or high heat. Avoid working in an area where overhead equipment or personnel could fall and contact the user, fall protection equipment, or the lifeline. Areas where the user's lifeline may cross or tangle with the lifeline of another user should be avoided. Do not allow the lifeline to pass under arms or between the legs.
- **Sharp Edges:** Safewaze **Class 1 SRLs** are NOT designed for use in Leading Edge Environments. Should a specific work area have an extremely sharp edge/edges that may come into contact with the lifeline constituent of the SRL, a Class 2 SRL is required.
- Use only the applicable D-ring for intended use.

▶ 7.0 ALLOWED ANCHORAGE APPLICATIONS

Personal Fall Arrest: Safewaze Anchors are designed as an anchor point to support a maximum of 1 PFAS when utilized for fall protection applications. The structure to which the anchor is attached must withstand loads applied in the directions permitted by the system of at least 5,000 lbs. (22 kN) or be designed with a safety factor of two to one. Maximum allowable free fall is based on the PFAS used.



Restraint: Safewaze Anchors are authorized for use in Restraint applications. The structure to which the anchor is attached must withstand loads applied in the directions permitted by the system of at least 1,000 lbs. NO free fall is permitted. Restraint systems may only be used on surfaces with slopes up to 4/12 (vertical/horizontal). For Restraint applications, the allowable attachment points to the harness are Dorsal, Front/Sternal, Side, and Shoulder D-rings.



Work Positioning: Safewaze Anchors are authorized for use in Work Positioning applications. Work Positioning allows a worker to be supported during suspension while freeing both hands to conduct work operations. The structure to which the anchor is attached must withstand loads applied in the directions permitted by the system of at least 3,000 lbs. Maximum allowable free fall is 2 ft. For positioning applications, the allowable attachment points to the harness are the Side D-rings.



Rescue/Confined Space: Safewaze Anchors are authorized for use in Rescue/Confined Space applications. Rescue systems are utilized to safely recover a worker from a confined location or after exposure to a fall. Composition of rescue systems can vary based upon the type of rescue involved. The structure to which the anchor is attached must withstand loads applied in the directions permitted by the system of at least 3,100 lbs. NO free fall is permitted for rescue scenarios. For confined space scenarios, maximum allowable free fall is based on the PFAS used. For these applications, the allowable attachment points to the harness are Dorsal, Front/Sternal, and Shoulder D-rings.



► 8.0 PRODUCT SPECIFICATIONS

- User Weight Capacity: ANSI 130-310 lbs. (59-141 kg) and OSHA up to 420 lbs. (191 kg). *including clothing, tools, equipment, etc.
- Designed for 6' (1.83 m) and 12' (3.66 m) free fall applications. For 12' free fall applications, the user must use a personal energy absorber (PEA) rated for 12' free fall.
- Features: 40 Cal/600 Degree Char Rated Aramid Sheathed Webbing, Label Cover with Size Indicator, Dorsal D-ring, Integrated SRL Channel, Breakaway Lanyard Keepers, Fixed Shoulder and Waist Pad.
- Multiple configurations offered for different D-ring connection points/belted and non-belted configurations.
- Sizes: X-Small/Small, Medium/Large, X-Large/2X, 3X.

COMPONENT MATERIALS	
Webbing	Aramid/Polyester
D-ring(s)/ Adjuster Buckles/ Chest Connection	Zinc-Plated Steel with EP Coating
Leg Connection	Zinc-Plated Steel with EP Coating, Stainless Steel Grommets (Based on Model)
Pads	EVA Foam, Fiberglass, Polyester
Lanyard Keepers	Nylon
Label Cover	Fiberglass and Polyester
Belt	Aramid/Polyester Webbing, Zinc-Plated Steel with EP Coating Buckle, Stainless Steel Grommets
Integrated SRL Channel	TPE and Polypropylene

► 9.0 FALL CLEARANCE

Always select an SRL/lanyard and anchor point location that limits free fall and swing fall as much as possible. Refer to the chosen PFAS system manuals for information on fall clearance. A free fall of more than 6 ft. could cause excessive arrest forces that could result in serious injury or death.

- **Fall Clearance:** There must be sufficient clearance below the anchorage connector to arrest a fall before the user strikes the ground or an obstruction. When calculating fall clearance, account for all applicable factors. A Competent Person must reference the entire system's components to calculate Fall Clearance.

THE FOLLOWING DIAGRAMS ARE EXAMPLES ONLY.

Note: Numbers used in these examples are based on ZERO offset and setback with the anchor directly overhead or below, to represent an in-line Fall Clearance calculation. Consult with a Competent Person when working in different scenarios and when using non-Safewaze equipment.

6' FREE FALL LANYARD (OVERHEAD) EXAMPLE

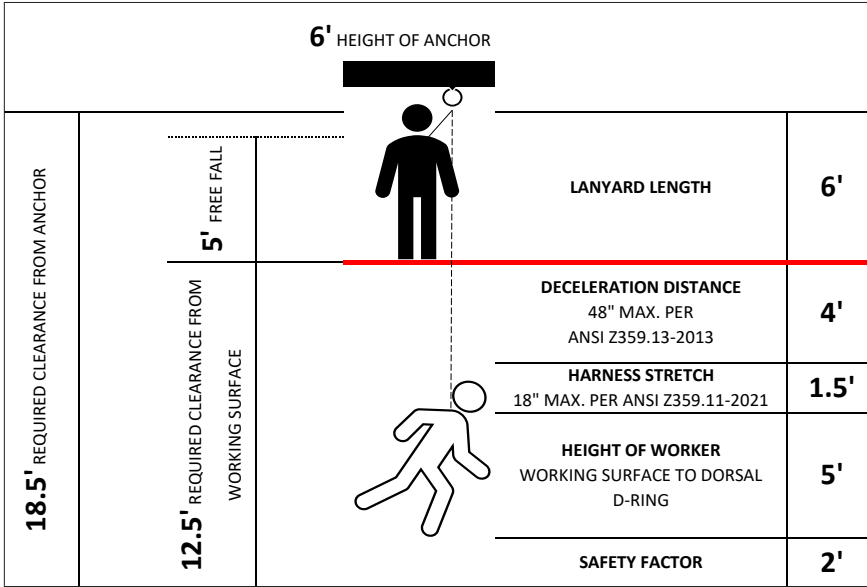

12' FREE FALL LANYARD (BELOW D-RING) EXAMPLE

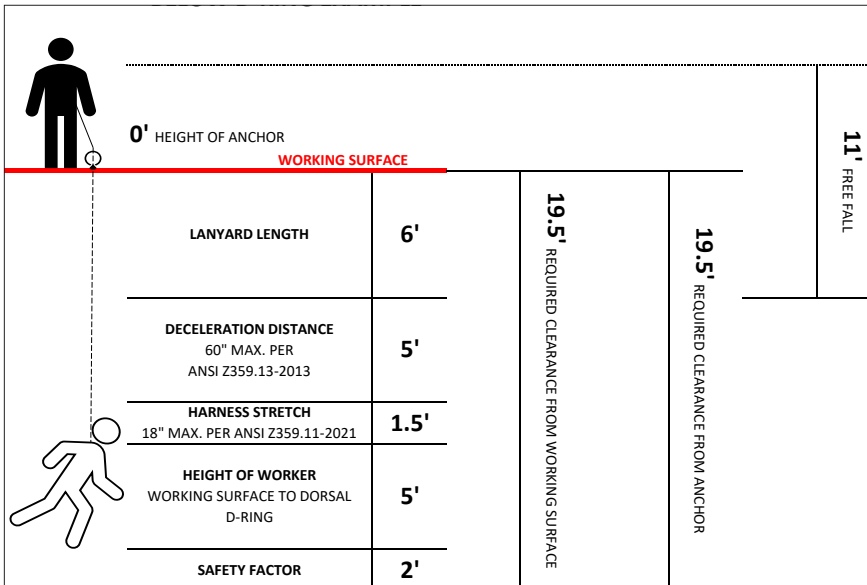

CLASS 1 (OVERHEAD) EXAMPLE

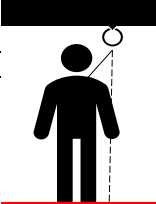
		6' HEIGHT OF ANCHOR	
13' REQUIRED CLEARANCE FROM ANCHOR	0' FREE FALL		
	7' REQUIRED CLEARANCE FROM WORKING SURFACE	WORKING SURFACE	
		ARREST DISTANCE 42" MAX. PER ANSI Z359.14-2021 CLASS 1	3.5'
		HARNESST STRETCH 18" MAX. PER ANSI Z359.11-2021	1.5'
		SAFETY FACTOR	2'
		SWING FALL DROP DISTANCE	TBD

CLASS 2 (BELOW D-RING) EXAMPLE

	0' HEIGHT OF ANCHOR		5' FREE FALL
	WORKING SURFACE		
	ARREST DISTANCE REFER TO MANUAL FOR PUBLISHED ARREST DISTANCES PER ANSI Z359.14-2021 CLASS 2	8'	16.5' REQUIRED CLEARANCE FROM WORKING SURFACE
	HARNESST STRETCH 18" MAX. PER ANSI Z359.11-2021	1.5'	
	HEIGHT OF WORKER WORKING SURFACE TO DORSAL D-RING	5'	
	SAFETY FACTOR	2'	
SWING FALL DROP DISTANCE		TBD	
		16.5' REQUIRED CLEARANCE FROM ANCHOR	

- **Swing Falls:** Prior to installation or use, make considerations for eliminating or minimizing all swing fall hazards. Swing falls occur when the anchor is not directly above the location where a fall occurs. Always work as close to, or in line with, the anchor point as possible. Swing falls significantly increase the likelihood of serious injury or death in the event of a fall. Ensure a Competent Person includes swing fall in calculations if the hazard exists.

SWING FALL:

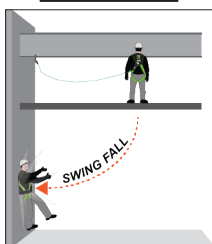

► 10.0 COMPATIBILITY OF CONNECTORS

- Safewaze equipment is designed for, and tested with, associated Safewaze components or systems. If substitutions or replacements are made, ensure all components meet the applicable ANSI requirements. Read and follow manufacturer's instructions for all components and subsystems in your PFAS. Not following this guidance may jeopardize compatibility of equipment and possibly affect the safety and reliability of the system.
- Connectors are compatible with connecting elements when they have been designed to work together in such a way that their sizes and shapes do not cause their gate mechanisms to inadvertently open regardless of how they become oriented.
- Connectors (hooks, carabiners, and D-rings) must be capable of supporting at least 5,000 lbs. (22 kN).
- Connectors must be compatible with the anchorage or other system components.
- Do not use equipment that is not compatible. Non-compatible connectors may unintentionally disengage.
- Connectors must be compatible in size, shape, and strength.
- Self-locking snap hooks and carabiners are required by OSHA guidelines.
- Some specialty connectors have additional requirements. Contact Safewaze if you have any questions about compatibility.

UNINTENTIONAL DISENGAGEMENT:

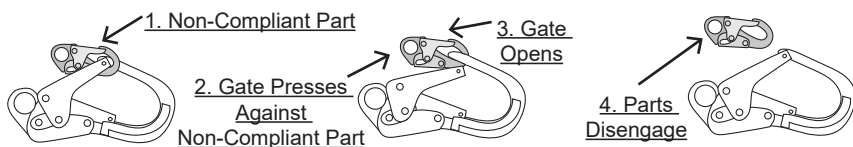

Using a connector that is undersized or irregular in shape (1) to connect a snap hook or carabiner could allow the connector to force open the gate of the snap hook or carabiner. When force is applied, the gate of the hook or carabiner presses against the non-compliant part (2) and forces open the gate (3). This allows the snap hook or carabiner to disengage (4) from the connection point.

► 11.0 MAKING CONNECTIONS

Snap hooks and carabiners used with this equipment must be double locking and/ or twist lock. Ensure all connections are compatible in size, shape, and strength. Do not use equipment that is not compatible. Ensure all connectors are fully closed and locked.

Safewaze connectors (hooks, carabiners, and D-rings) are designed to be used only as specified in each product’s manual. See figure below for examples of inappropriate connections. Do not connect snap hooks and carabiners:

- To a D-ring to which another connector is attached.
- In a manner that would result in a load on the gate (with the exception of tie-back hooks).
- In a false engagement, where features that protrude from the snap hook or carabiner catch on the anchor, and without visual confirmation seems to be fully engaged to the anchor point.
- To each other.
- By wrapping the web lifeline around an anchor and securing to lifeline, except as allowed for tie-back models.
- To any object which is shaped or sized in a way that the snap hook or carabiner will not close and lock, or that roll-out could occur.
- In a manner that does not allow the connector to align properly while under load.

INAPPROPRIATE CONNECTIONS:

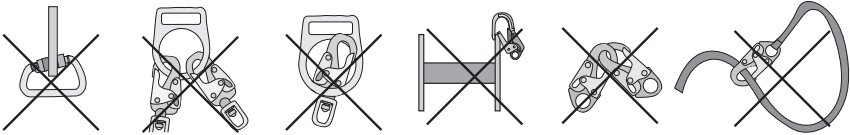

Large throat snap hooks must not be connected to standard size D-rings or similar objects which will result in a load on the gate if the hook or D-ring twists or rotates, unless the snap hook complies with ANSI Z359.1-2007 or ANSI Z359.12 and is equipped with a 3,600 lb. (16 kN) gate.

► 12.0 HARNESS SIZING AND PRE-INSPECTION

In the event of a fall, a properly sized harness is critical in ensuring the function of the harness and associated fall protection equipment. An improperly sized harness will prevent the harness from performing in a manner that effectively protects the user.

See chart below for sizing of Safewaze harnesses based on the users height and weight and the following table for belt sizing based on waist measurement. This sizing is based upon average body dimensions. Sizing for each individual user shall be verified through the process of putting the harness on to ensure its proper function and fit.

HARNESS SIZING:

	XS	S	M	L	XL	2X	3X											
HEIGHT - FT./IN. (M)																		
6'10" (2.08)						3X												
6'8" (2.03)					2X													
6'6" (1.98)				XL														
6'4" (1.93)			L															
6'2" (1.88)		M																
6' (1.83)		S																
5'10" (1.78)																		
5'8" (1.68)	XS																	
5'6" (1.68)																		
5'4" (1.63)																		
5'2" (1.63)																		
5' (1.52)																		
4'10" (1.47)																		
	80 (36)	100 (45)	120 (54)	140 (63)	160 (73)	180 (82)	200 (91)	220 (100)	240 (109)	260 (118)	280 (127)	300 (136)	320 (145)	340 (154)	360 (163)	380 (172)	400 (181)	420 (190)
	WEIGHT - LBS. (KG)																	

BELT SIZING:

SIZE:	MEASUREMENT:	DUAL SIZES:	MEASUREMENT:
XS	28"-38.5"	XS/S	28.5"-42.5"
S	32"-42.5"	S/M	33"-46.5"
M	36"-46.5"	M/L	36.5"-50.5"
L	40"-50.5"	L/XL	41"-54.5"
XL	44"-54.5"	XL/2X	44.5"-58.5"
2X	48"-58.5"	2X/3X	49"-62.5"
3X	52"-62.5"	3X/4X	53"-66.5"
4X	56"-66.5"		

Upon receiving a Safewaze harness, remove the harness from the packaging and fully inspect for possible damage that may have occurred during shipping (See Section 19 for Full Inspection Procedures).

Additionally, all Safewaze harnesses include sewn-in load indicators to warn if the harness has been subjected to fall arrest forces. The load indicators are located on the rear torso straps of the harness (Fig. 1).

Figures 2 & 3 indicate the load indicators in a non-deployed (Fig. 2) and deployed (Fig. 3) status. If pre-use (or scheduled) inspections reveal that either of the load indicators are deployed, the harness **must be removed from service** and destroyed.

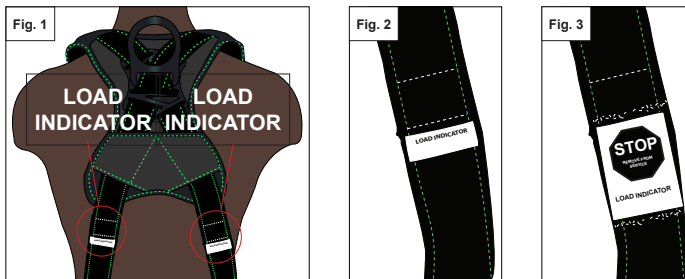

▶ 13.0 PUTTING ON AND ADJUSTING HARNESS

Safewaze harnesses are offered in a variety of configurations (Sections 14-16). The following steps of putting on and adjusting the harness are correct regardless of the harness configuration:

1. Hold the harness by its dorsal D-ring and allow it to hang freely. Ensure the harness straps are unbuckled, not twisted, and not tangled.
2. Slip one arm in each arm opening as if putting on a vest.
3. Pull leg straps between legs and connect the leg buckles. Adjust length of leg straps to ensure a snug fit on both legs. For a belted harness, connect the waist belt after the leg straps.
4. Fasten the chest strap across chest, just under the sternum. Adjust to provide a snug fit. Chest strap should not be close to the user's neck.

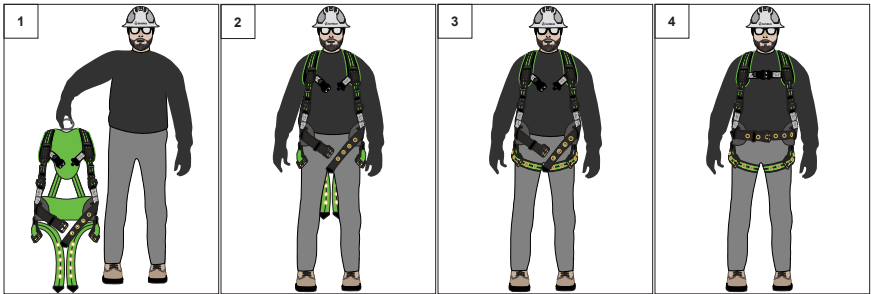

Once leg straps, waist belt (if applicable), and chest strap are buckled, use the adjusters to tighten or loosen harness until a snug fit is achieved. The harness should allow for a full range of movement. **Note:** Pass any excess strap webbing through plastic or elastic keepers.

The following steps of putting on and adjusting the harness should be followed for crossover Safewaze harness styles:

1. Disconnect the torso connection point of the harness.
2. Hold the harness by its dorsal D-ring and allow it to hang freely. Ensure the harness straps are unbuckled, not twisted, and not tangled.
3. Pull harness over head. The head should go through the hole between the shoulder straps.
4. Connect torso connection point.
5. Pull leg straps between legs and connect the leg buckles. Adjust length of leg straps to ensure a snug fit on both legs.
6. Adjust the front D-ring with the torso adjusters until desired location is reached.
7. Adjust harness straps to provide a snug fit.

The harness should allow for a full range of movement. **Note:** Pass any excess strap webbing through plastic or elastic keepers.

► 14.0 BUCKLE TYPES AND OPERATION

- **For a Mating Buckle--** Insert smaller buckle through larger buckle and lay flat together.
- **For a Tongue Buckle--** Insert strap through tongue buckle until snug fit. Insert tongue buckle through strap grommet.
- **For a Quick-Connect Buckle--** Connect buckles until a "click" is heard and the green dot is present. To disconnect, push prongs and pull buckles apart.

MATING BUCKLE:

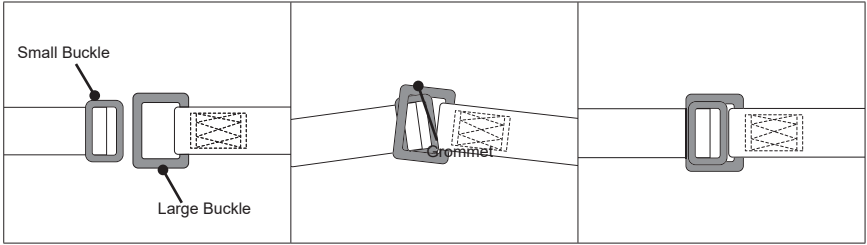

TONGUE BUCKLE:

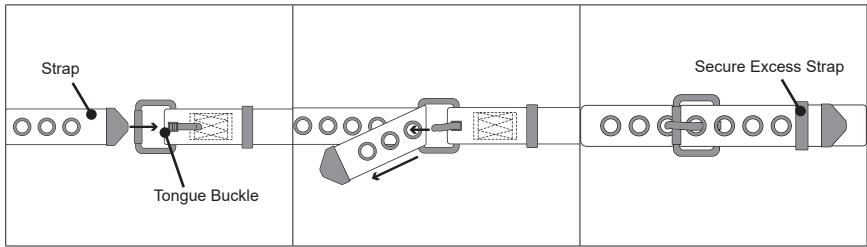

QUICK-CONNECT BUCKLE

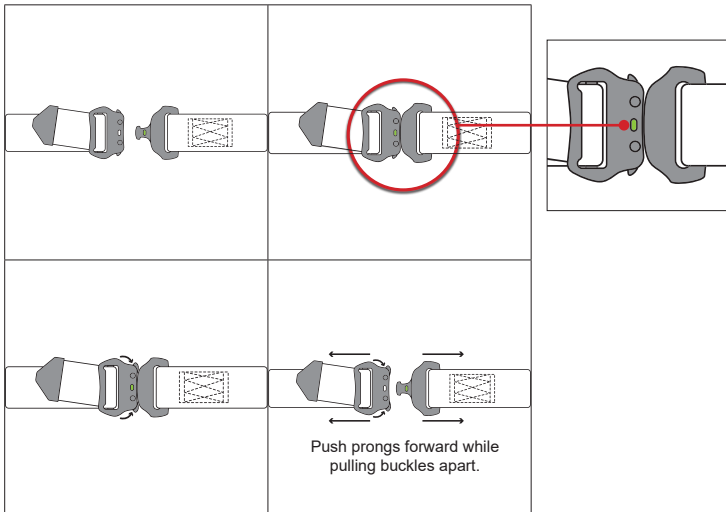

► 15.0 TORSO ADJUSTERS AND OPERATION

The V-Select Hot Work series mainly utilizes Friction Adjusters. However, Mating Buckle Torso Adjusters are offered on certain crossover-style models.

- **For the Friction Adjusters--** To shorten the FBH torso straps, pull up on the free end of the torso strap. The webbing will move through the friction bar until desired length is reached. To lengthen the FBH torso straps, push webbing down through the friction bar to release tension on the torso strap webbing and adjust length as needed. **Note:** Stow any excess webbing with the plastic or elastic keepers.
- **For the Mating Buckle Torso Adjusters--** The torso strap will go under both buckles and then in-between both buckles as shown. To shorten the FBH torso straps, pull up on the free end of the torso strap. To lengthen the FBH torso straps, feed the free end of the torso strap back down through the buckles until desired length is reached. **Note:** Stow any excess webbing with the plastic or elastic keepers.

FRICITION ADJUSTER:

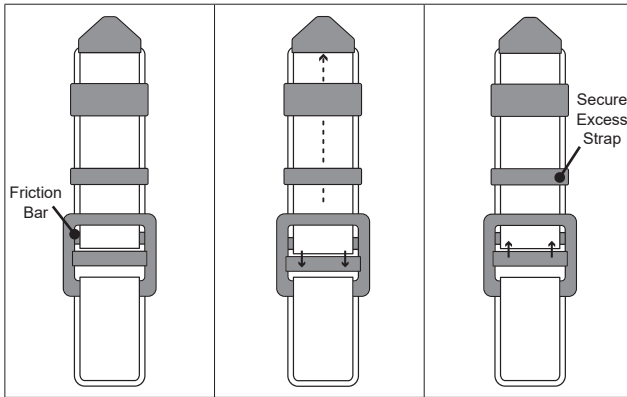

MATING BUCKLE TORSO ADJUSTER:

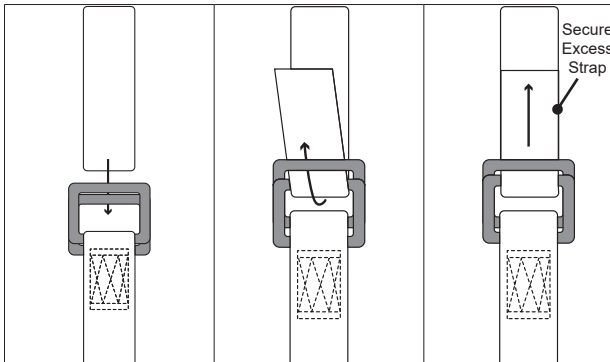

▶ 16.0 SRL CONNECTION POINT

The Integrated SRL Channel is an integral part of the harness. The channel offers a simple connection point for any of the Safewaze BWBs with an enhanced dorsal D-ring pad. The bracket slides into the Integrated SRL Channel.

For full instructions regarding BWB installation and SRL connection to harness, see the product manual for the specific SRL utilized. See image below for the location of the SRL connection point:

INTEGRATED SRL CHANNEL:



▶ 17.0 LANYARD KEEPERS

If using a dual-leg lanyard or self-retracting lifeline connecting device, the user must ensure that the unused leg of the device is properly stowed when not actively in use. Safewaze harnesses are equipped with two lanyard keepers-- one on each torso strap. These lanyard keepers provide a location to attach the unused device leg while keeping them easily accessible and clear of ongoing work operations. If a lanyard keeper breaks, Replacement Lanyard Keepers (021-9038) can be ordered and installed onto the harness. See figures below for location of lanyard keepers and proper use.

PROPER USE OF LANYARD KEEPER:

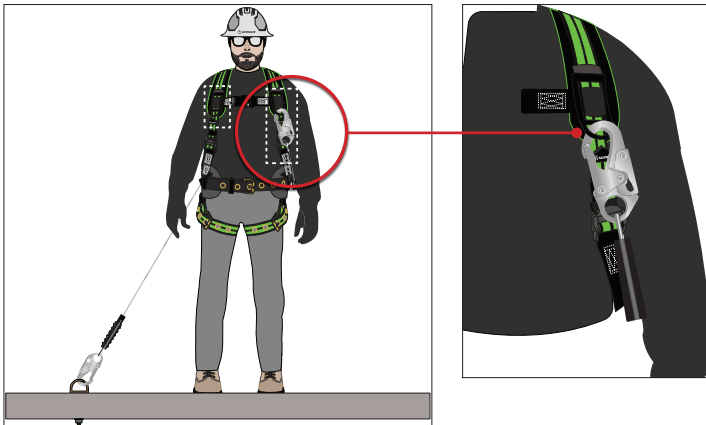

► 18.0 HARNESS CONNECTION EXAMPLES

Safewaze V-Select Hot Work Harnesses can be used for Personal Fall Arrest, Restraint, Work Positioning, and Rescue/Confined Space applications. See figures below for examples of harness connection points.

HARNESS CONNECTION EXAMPLES:

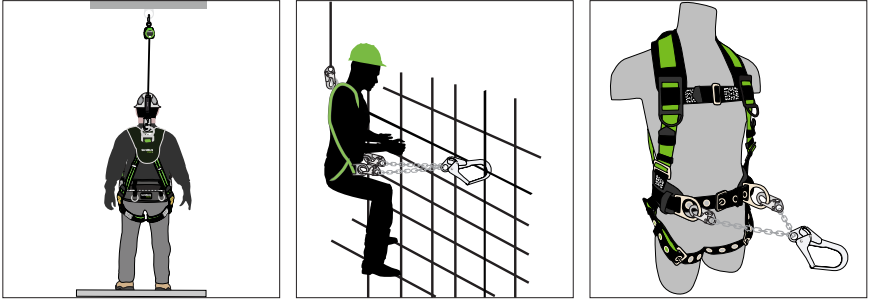

► 19.0 INSPECTION & MAINTENANCE

The user must keep instructions available for reference and record the date of first use on Page 2. The user must immediately remove the system from service if defects or damage are found, or if exposed to forces of fall arrest.

Work Area:

- Inspect the work area to ensure the location is free of any damage including, but not limited to, debris, cracking, rot, decay, structural deterioration, rust, and any hazardous materials.
- A Competent Person must determine that the installation location to be utilized will support the intended loads.

Frequency:

- A Competent Person, other than the user, must inspect the harness at least once annually.
- While conducting inspections, the Competent Person must consider all applications and hazards that the equipment may have been subjected to while in use.
- Competent Person inspections must be recorded in the Inspection Log included in this manual (Page 27), as well as the inspection table labels on each product individually. The Competent Person must place their initials in the block which corresponds with the month and year that the inspection is performed. All individual labels on the equipment will be initialed in the same manner.
- See the following table for more information regarding inspection frequency requirements.

INSPECTION FREQUENCY:

Type of Use	Application Examples	Conditions of Use	Inspection Frequency by Competent Person
Infrequent to Light	Rescue and Confined Space, Factory Maintenance	Good Storage Conditions, Indoor or Infrequent Outdoor Use, Room Temperature, Clean Environments	Annually
Moderate to Heavy	Transportation, Residential Construction, Utilities, Warehouse	Fair Storage Conditions, Indoor and Extended Outdoor Use, All Temperatures, Clean or Dusty Environments	Semi-Annually to Annually
Severe to Continuous	Commercial Construction, Oil and Gas, Mining	Harsh Storage Conditions, Prolonged or Continuous Outdoor Use, All Temperatures, Dirty Environment	Quarterly to Semi-Annually

Directions:

- Prior to each use, inspect the harness for possible deficiencies including, but not limited to, missing parts, corrosion, deformation, pits, burrs, rough surfaces, sharp edges, cracking, rust, paint buildup, excessive heating, alteration, and missing or illegible labels.
- Prior to each use, the user must inspect and verify that each individual component (Images 2 & 3) of the harness is safe for use:
 1. Inspect the webbing of the harness for cuts, frays, broken stitching, damage from heat or chemical exposure, or other defects related to excessive wear or abrasion (Image 1).
 2. Inspect sizing adjusters for proper function and ensure correct sizing of harness for use.
 3. If applicable, inspect waist strap/belt assembly for proper function and ensure no excessive corrosion exists.
 4. Inspect the harness hardware for missing parts, corrosion, deformation, cracking, rust, paint buildup, alteration, or other defects related to excessive wear or abrasion. If applicable, ensure no grommets are loose or missing.
 5. Inspect load indicators to ensure the harness has not been exposed to fall arrest forces.
 6. Inspect labeling to ensure that they are legible and present on the harness. If any labeling is illegible, or missing, remove the FBH from service.

Note: Refer to the specific manufacturer's product manual to inspect the connecting devices attached to the harness.

IMAGE 1: WEB DAMAGE EXAMPLES

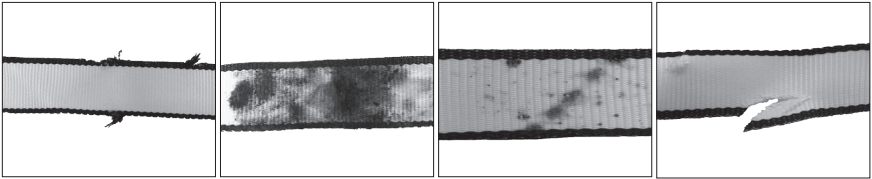

Repairs:

- Only Safewaze, or entities authorized in writing by Safewaze, may make repairs to Safewaze fall protection equipment.

Cleaning:

- The harness can be cleaned with water and mild soap. The user shall remove all dirt, possible corrosives, and contaminants from the system prior to, and after, each use. Never use any type of corrosive substance to clean the system.
- Excess water shall be blown out with compressed air. Hardware can be wiped off with a clean, dry cloth. Do not store system if wet or damp. Allow equipment to fully dry before being stored.

Storage:

- Prior to installation, store the system in a cool, dry area where it will not be exposed to extreme light, extreme heat, excessive moisture, or possibly corrosive chemicals or materials.

Lifespan:

- The working life of the harness is determined by work conditions, care, and inspection provided. So long as the system and all components pass inspection, it may remain in service.

Disposal:

- Dispose of the harness if inspection reveals an unsafe or defective condition. If damaged and unserviceable, the system must be destroyed so as not to allow accidental re-use.

IMAGES 2 & 3: COMPONENTS INSPECTION

FRONT

BACK



1	Webbing
2	Chest Slides/Lanyard Keepers
3	Buckles
4	Plastic/Elastic Web Keepers
5	Waist Pad/Belt (If Applicable)
6	Leg Connection
7	D-ring
8	Load Indicators
9	Labels

Notes: Ensure load indicators are not deployed (Page 13).

► 22.0 ANSI/ASSP Z359.11, ANNEX A

Annex A – Normative

Note: The following information from the ANSI/ASSP Z359.11 standard is required to be included in the instruction manual for the end user. The manufacturer of this equipment may impose more stringent restrictions on the use of the products they manufactures; see the manufacturer's instructions.

1. It is essential that the users of this type of equipment receive proper training and instruction including detailed procedures for the safe use of such equipment in their work application. ANSI/ASSP Z39.2, *Minimum Requirements for a Comprehensive Managed Fall Protection Program*, establishes guidelines and requirements for an employer's managed fall protection program including policies, duties and training; fall protection procedures; eliminating and controlling fall hazards; rescue procedures; incident investigations; and evaluating program effectiveness.
2. Correct fit of a full body harness (FBH) is essential to proper performance. Users must be trained to select the size and maintain the fit of their FBH.
3. Users must follow manufacturer's instructions for proper fit and sizing, paying particular attention to ensure the buckles are connected and aligned correctly, leg straps and shoulder straps are kept snug at all times, chest straps are located in the middle chest area and leg straps are positioned and snug to avoid contact with the genitalia should a fall occur.
4. FBHs which meet ANSI/ASSP Z359.11 are intended to be used with other components of a personal fall arrest system that limit maximum arrest forces to 1800 pounds (8kN) or less.
5. Suspension intolerance, also called suspension trauma or orthostatic intolerance, is a serious condition that can be controlled with good harness design, prompt rescue and post fall suspension relief devices. A conscious user may deploy a suspension relief device allowing the user to remove tension from around the legs, freeing blood flow, which can delay the onset of suspension intolerance. An attachment element extender is not intended to be attached directly to an anchorage or anchorage connector for fall arrest. An energy absorber must be used to limit maximum arrest forces to 1800 pounds (8kN). The length of the attachment element extender may affect free fall distances and free fall clearance calculations.
6. FBH stretch, the amount the FBH component of a personal fall arrest system will stretch and deform during a fall, can contribute to the overall elongation of the system in stopping a fall. It is important to include the increase in fall distance created by FBH stretch, as well as the FBH connector length, the settling of the user's body in the FBH and all other contributing factors when calculating total clearance required for a particular fall arrest system.
7. When not in use, unused lanyard legs that are still attached to a FBH D-ring should not be attached to a work positioning element or any other structural element on the FBH unless deemed acceptable by the competent person and manufacturer of the lanyard. This is especially important when using some types of "Y" style lanyards, as some load may be transmitted to the user through the unused lanyard leg if it is not able to release from the harness. The lanyard parking attachment is generally located in the sternal area to help reduce tripping and entanglement hazards.
8. Loose ends of straps can get caught in machinery or cause accidental disengagement of an adjuster. All FBH shall include keepers or other components which serve to control the loose ends of straps.
9. Due to the nature of soft loop connections, it is recommended that soft loop attachments only be used to connect with other soft loops or carabiners. Snaphooks should not be used unless approved for the application by the manufacturer.

Sections 10-16 provide additional information concerning the location and use of various attachments that may be provided on this FBH.

10. **Dorsal** – The dorsal attachment element shall be used as the primary fall arrest attachment unless the application allows the use of an alternate attachment. The dorsal attachment may also be used for travel restraint or rescue. When supported by the dorsal attachment during a fall, the design of the FBH shall direct load through the shoulder straps supporting the user and around the thighs. Supporting the user, post fall, by the dorsal attachment will result in an upright body position with a slight lean to the front with some slight pressure to the lower chest. Considerations should be made when choosing a sliding versus fixed dorsal attachment element. Sliding dorsal attachments are generally easier to adjust to different user sizes, and allow a more vertical rest position post fall, but can increase FBH stretch.
11. **Sternal** – The sternal attachment may be used as an alternative fall arrest attachment in applications where the dorsal attachment is determined to be inappropriate by a competent person and where there is no chance to fall in a direction other than feet first. Accepted practical uses for a sternal attachment include, but are not limited to, ladder climbing with a guided type fall arrester, ladder climbing with an overhead self-retracting lifeline for fall arrest, work positioning and rope access. The sternal attachment may also be used for travel restraint or rescue.

When supported by the sternal attachment during a fall, the design of the FBH shall direct load through the shoulder straps supporting the user and around the thighs. Supporting the user, post fall, by the sternal attachment will result in roughly a sitting or cradled body position with weight concentrated on the thighs, buttocks and lower back. Supporting the user during work positioning by this sternal attachment will result in an approximate upright body position.

If the sternal attachment is used for fall arrest, the competent person evaluating the application should take measures to ensure that a fall can only occur feet first. This may include limiting the allowable free fall distance. It may be possible for a sternal attachment incorporated into an adjustable style chest strap to cause the chest strap to slide up and possibly choke the user during a fall, extraction, suspension, etc. The competent person should consider FBH models with a fixed sternal attachment for these applications.

12. **Frontal** – The frontal attachment serves as a ladder climbing connection for guided type fall arresters where there is no chance to fall in a direction other than feet first or may be used for work positioning. Supporting the user, post fall or during work positioning, by the frontal attachment will result in a sitting body position with the upper torso upright with weight concentrated on the thighs and buttocks. When supported by the frontal attachment the design of the FBH shall direct load directly around the thighs and under the buttocks by means of the sub-pelvic strap.

If the frontal attachment is used for fall arrest, the competent person evaluating the application should take measures to ensure that a fall can only occur feet first. This may include limiting the allowable free fall distance.

13. **Shoulder** – The shoulder attachment elements shall be used as a pair and are acceptable attachment for rescue and entry/retrieval. The shoulder attachment elements shall not be used for fall arrest. It is recommended that the shoulder attachment elements be used in conjunction with a yoke which incorporates a spreader element to keep the FBH shoulder straps separate.
14. **Waist, Rear** – The waist, rear attachment shall be used solely for travel restraint. The waist, rear attachment element shall not be used for fall arrest. Under no circumstances is it acceptable to use the waist, rear attachment for purposes other than travel restraint. The waist, rear attachment shall only be subjected to minimal

loading through the waist of the user and shall never be used to support the full weight of the user.

15. **Hip** – The hip attachment elements shall be used as a pair and shall be used solely for work positioning. The hip attachment element shall not be used for fall arrest. Hip attachments are often used for work positioning by arborists, utility workers climbing poles and construction workers tying rebar and climbing on form walls. Users are cautioned against using the hip attachment elements (or any other rigid point on the FBH) to store the unused end of a fall arrest lanyard as this may cause a tripping hazard or, in the case of multiple leg lanyards, could cause adverse loading to the FBH and the wearer through the unused portion of the lanyard.
16. **Suspension Seat** – The suspension seat attachment elements shall be used as a pair and shall be used solely for work positioning. The suspension seat attachment elements shall not be used for fall arrest. Suspension seat attachments are often used for prolonged work activities where the user is suspended allowing the user to sit on the suspension seat formed between the two attachment elements. An example of this use would be window washers on large buildings.

USER INSPECTION, MAINTENANCE AND STORAGE OF EQUIPMENT

Users of personal fall arrest systems shall, at a minimum, comply with all manufacturer instructions regarding the inspection, maintenance and storage of the equipment. The user's organization shall retain the manufacturer's instructions and make them readily available to all users. See ANSI/ASSP Z359.2, *Minimum Requirements for a Comprehensive Managed Fall Protection Program*, regarding user inspection, maintenance and storage of equipment.

1. In addition to the inspection requirements set forth in the manufacturer's instructions, the equipment shall be inspected by the user before each use and additionally by a competent person, other than the user, at interval of no more than one year for:
 - Absence or illegibility of markings.
 - Absence of any elements affecting the equipment form, fit or function.
 - Evidence of defects in, or damage to, hardware elements including cracks, sharp edges, deformation, corrosion, chemical attack, excessive heating, alteration and excessive wear.
 - Evidence of defects in, or damage to, strap or ropes including fraying, unsplicing, unlaying, kinking, knotting, roping, broken or pulled stitches, excessive elongation, chemical attack, excessive soiling, abrasion, alteration, needed or excessive lubrication, excessive aging and excessive wear.
2. Inspection criteria for the equipment shall be set by the user's organization. Such criteria for the equipment shall equal or exceed the criteria established by this standard or the manufacturer's instructions, whichever is greater.
3. When inspection reveals defects in, damage to, or inadequate maintenance of equipment, the equipment shall be permanently removed from service or undergo adequate corrective maintenance by the original equipment manufacturer or their designate before return to service.

MAINTENANCE AND STORAGE

1. Maintenance and storage of equipment shall be conducted by the user's organization in accordance with the manufacturer's instructions. Unique issues, which may arise due to conditions of use, shall be addressed with the manufacturer.
2. Equipment, which is in need of, or scheduled for, maintenance shall be tagged as unusable and removed from service.
3. Equipment shall be stored in a manner as to preclude damage from environmental factors such as temperature, light, UV, excessive moisture, oil, chemicals and their vapors or other degrading elements.

▶ 23.0 HARNESS INSPECTION CHECKLIST



INSPECTION FORM HARNESSES

Manufacturer: _____
 Model Number: _____
 Description: _____
 Serial Number: _____
 Lot Number: _____
 Date of Manufacture: _____

Company: _____
 Name of Inspector: _____
 Signature: _____
 Date of Inspection: _____
 In-Service Date: _____
 Harness Configuration: Chest Strap PT TB Leg Straps PT TB Waist Belt Yes No

LABELS & MARKINGS

	PASS	FAIL	NOTE
Label (Intact and Legible)	<input type="checkbox"/>	<input type="checkbox"/>	<input type="checkbox"/>
Appropriate ANSI / OSHA / CSA Markings	<input type="checkbox"/>	<input type="checkbox"/>	<input type="checkbox"/>
Inspections are Current / Up-to-Date	<input type="checkbox"/>	<input type="checkbox"/>	<input type="checkbox"/>
Date of First Use	<input type="checkbox"/>	<input type="checkbox"/>	<input type="checkbox"/>
Impact / Fall Indicators Not Deployed	<input type="checkbox"/>	<input type="checkbox"/>	<input type="checkbox"/>

HARDWARE (Buckles & D-Rings)

	PASS	FAIL	NOTE
Signs of Deformity or Damage	<input type="checkbox"/>	<input type="checkbox"/>	<input type="checkbox"/>
Proper D-ring attachment and operation	<input type="checkbox"/>	<input type="checkbox"/>	<input type="checkbox"/>
All Buckles Undamaged and Operational	<input type="checkbox"/>	<input type="checkbox"/>	<input type="checkbox"/>
Corrosion / Pitting / Nicks	<input type="checkbox"/>	<input type="checkbox"/>	<input type="checkbox"/>
Ensure Grommets are Secure / Do Not Move	<input type="checkbox"/>	<input type="checkbox"/>	<input type="checkbox"/>

WEBBING

	PASS	FAIL	NOTE
Shoulder / Chest / Leg / Back Straps	<input type="checkbox"/>	<input type="checkbox"/>	<input type="checkbox"/>
Cuts / Burns / Holes	<input type="checkbox"/>	<input type="checkbox"/>	<input type="checkbox"/>
Paint Contamination	<input type="checkbox"/>	<input type="checkbox"/>	<input type="checkbox"/>
Excessive Wear	<input type="checkbox"/>	<input type="checkbox"/>	<input type="checkbox"/>
Heat / UV Damage	<input type="checkbox"/>	<input type="checkbox"/>	<input type="checkbox"/>

STITCHING

	PASS	FAIL	NOTE
Shoulder / Chest / Leg / Back Straps	<input type="checkbox"/>	<input type="checkbox"/>	<input type="checkbox"/>

































NOTES



▶ 24.0 ANNUAL INSPECTION FORM



SAFEWAZE

Inspection Date:	Inspector:	Pass/Fail:  	Comments/ Corrective Action:
		 	
		 	
		 	
		 	
		 	
		 	
		 	
		 	
		 	
		 	
		 	
		 	
		 	
		 	
		 	



SAFEWAZE

Address: 225 Wilshire Ave SW, Concord, NC 28025

Phone: (800) 230-0319

Fax: 704-262-9051

Email: info@safewaze.com

Website: safewaze.com