

# US 48V105 - Data Sheet

# ESSENTIALi<sup>®</sup>

POWERED BY U.S. BATTERY MFG. CO.

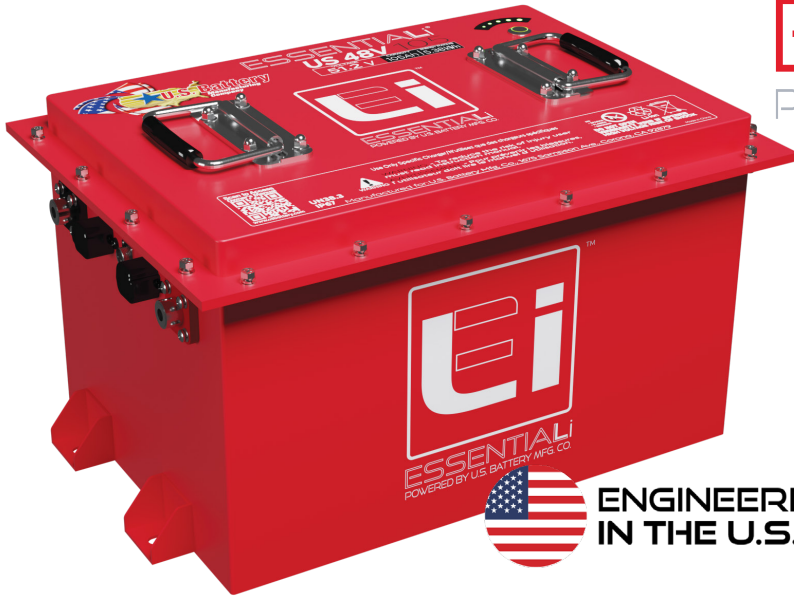

**ENGINEERED  
IN THE U.S.A.**

Lithium-Ion Battery  
**51.2 V | 105AH (5.38kWh)**

CELL CHEMISTRY:

**Lithium Iron Phosphate (LFP)**

CASE:

**SECC Steel**

Dimensions:

**17.44" w x 12.60" l x 10.32" h**

BCI GROUP SIZE:

**N/A**

## FEATURES

- **IP67 rated construction** prevents damage from outside particles and moisture.
- **CAN Networking** automotive grade connections allow manufacturers to integrate the battery with devices such as motor controllers and chargers to allow for communication of battery status.
- **Scalable** multiple batteries can be used in parallel for increased capacity.
- **State-of-the-Art Battery Management System (BMS)** Utilizes intelligent algorithms to help ensure accurate State of Charge (SOC), delivers advanced cell balancing, and enhanced fault detection and handling for optimal performance.

## BATTERY SPECIFICATIONS

BCI Group Size	Model	Terminal	Terminal Torque	Dimensions (mm)(±3mm)			Weight (kg)
				Length	Width	Height	
N/A	US 48V105	M8 insert	90 IN-LBS	17.44" (443)	12.60" (320)	10.32" (262)	92.6 (42)

Internal Protection information: See User's Guide [www.usbattery.com/info-center/essentialowner](http://www.usbattery.com/info-center/essentialowner)

## ELECTRICAL SPECIFICATIONS

Voltage	Capacity	Max Continous Discharge Current	Max 30S Discharge Current	Max 10S Discharge Current
51.2 V	105 Ah	150A	250A	300A
Max Charge Current	Self Discharge Rate	Low Voltage Cutoff	High Voltage Cutoff	
105A	3.5%/month (In Off Mode)	40V (Cell 2.5V)	58.4V (Cell 3.65V)	

## OPERATIONAL SPECIFICATIONS

Discharging	Charging	Storage
14°F~140°F (-10°C~60°C)	32°F~131°F (0°C~55°C)	50°F~95°F (10°C~35°C)

## SAFETY/REGULATORY INFORMATION

Certifications			
Transport	Shipping Classification	Cells	Pack
UN/DoT 38.3	UN3480, Class 9	UL2580	UL2271



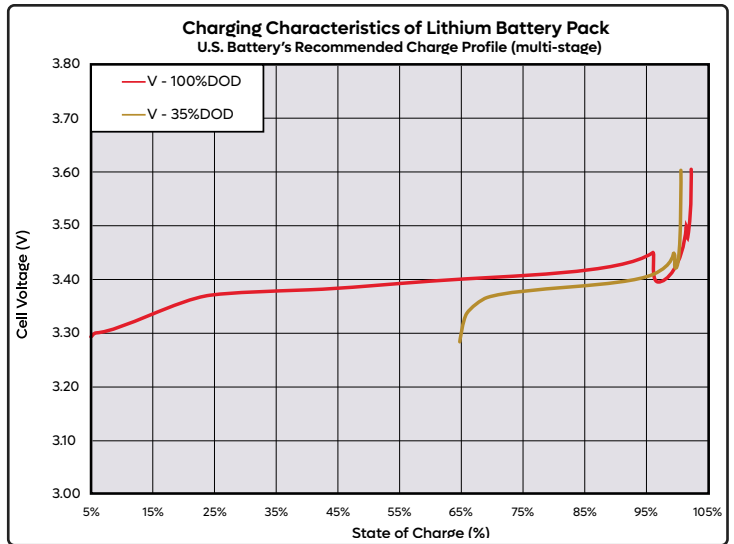
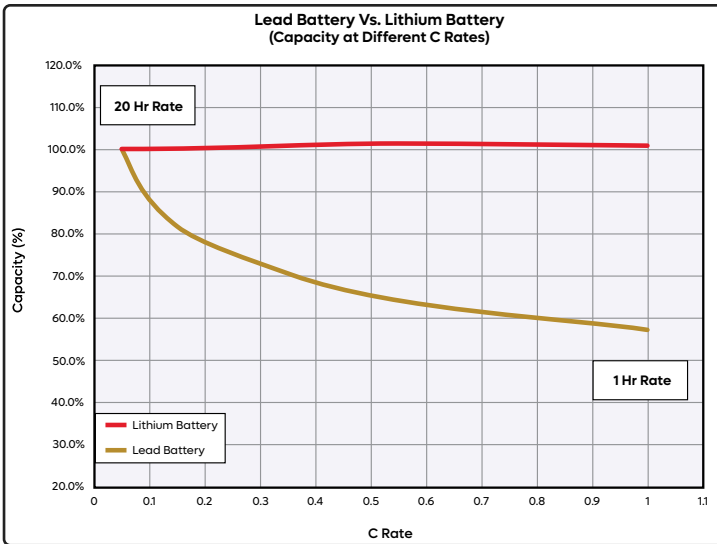
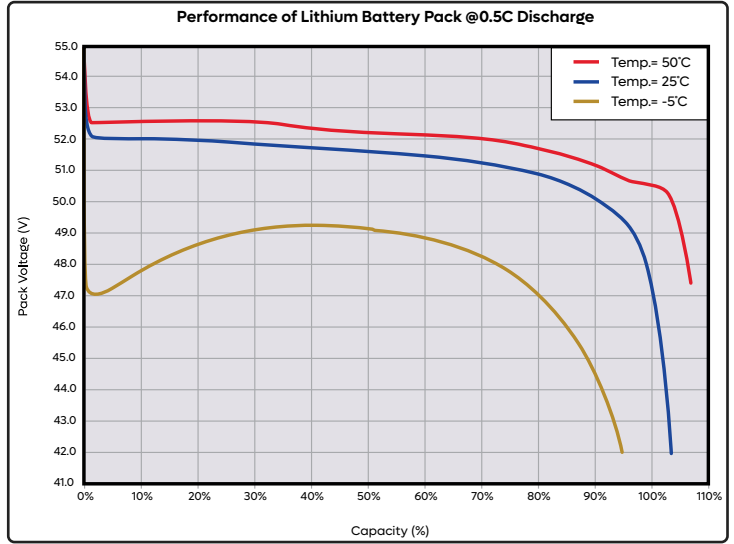
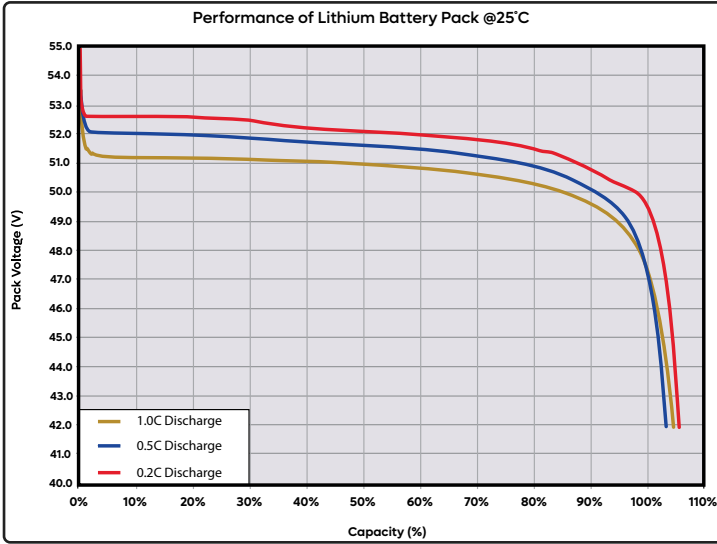
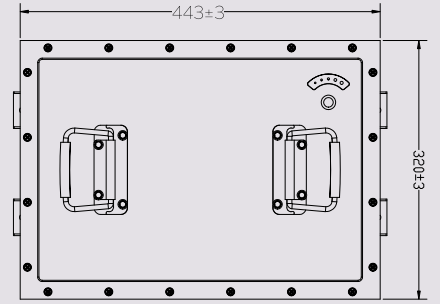
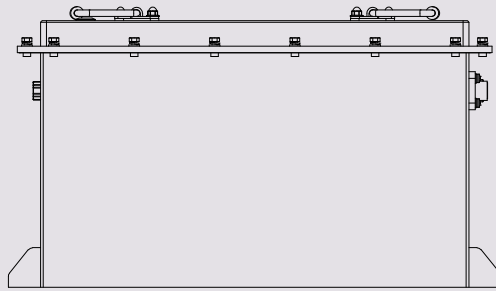
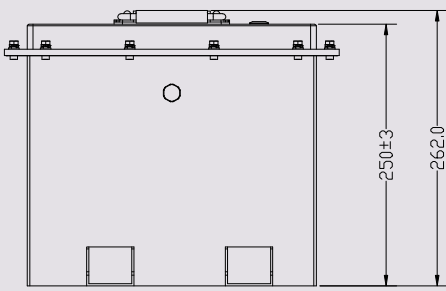

1675 Sampson Avenue  
Corona, CA 92879  
(800) 695-0945

1895 Tobacco Road  
Augusta, GA 30906  
(800) 522-0945

717 North Belair Rd.  
Evans, GA 30809  
(888) 811-0945

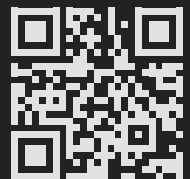

Data references within this publication are nominal and should not be considered or construed as maximum or minimum values for specifications or for final design. Data for this product type and model may vary from what is shown in this publication, and U.S. Battery Mfg. Co. makes No warranties, expressed or implied based on the data within this publication.

©2025 U.S. Battery Mfg. Co. All rights reserved. U.S. Battery is not liable for damages that may occur from any information provided in or omitted from this publication, under any circumstances. U.S. Battery Mfg. Co. reserves the right to make changes or adjustments to this publication at any time without notices or obligations.