

20x12 Hardtop Gazebo / Pavillon De Jardin A Auvent Rigide

Item/Article #: A1020436A100

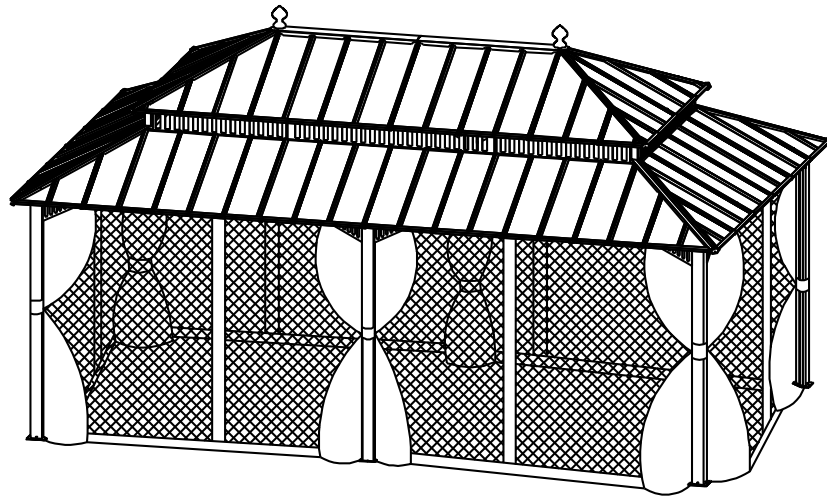

***Questions? Issues? Missing Part? Professional
Installation Service?***

Contact us at customer.care@sunjoygroup.com

Questions? Problèmes? Pièce manquante?

***Service d'installation professionnel? Contactez-
nous à customer.care@sunjoygroup.com***



A1020436A10025



Country of Origin: China
Pais d'origine: Chine

Production Number: 2025100722
Numéro de fabrication: 2025100722

Warnings :

- Any assembly or maintenance of the product must be carried out by adults only. We recommend at least 4 adults. / Tout montage ou entretien du produit doit être effectué uniquement par des adultes. Nous recommandons au moins 4 adultes.
- Please check your state and local regulations prior to purchasing. Some jurisdictions may require permits for installation and use. Some special procedures may be valid in your area. / Veuillez vérifier les réglementations nationales et locales avant d'acheter. Certaines juridictions peuvent exiger des permis pour l'installation et l'utilisation. Certaines procédures spéciales peuvent être valides dans votre région.
- Do not assemble the gazebo on sandy, muddy or loose soil, as stakes do not have enough anchorage in these types of soil. / Ne montez pas la tonnelle sur un sol sablonneux, boueux ou meuble, car les piquets n'ont pas assez d'ancrage dans ces types de sol.
- Install the gazebo on level ground . Stakes are provided to secure the gazebo to the ground./ Installez le belvédère sur un sol plat. Des piquets sont fournis pour fixer la tonnelle au sol.
- If you wish to secure the gazebo to a wood deck or concrete surface, use anchors suited to these surfaces (anchors not included)./Si vous souhaitez fixer le gazebo à une terrasse en bois ou à une surface en béton,utilisez des ancrages adaptés à ces surfaces (ancrages non inclus).
- Some parts may contain sharp edges. Wearing protective gloves is advised. / Certaines pièces peuvent contenir des bords tranchants. Portez des gants de protection si nécessaire.
- Keep children and pets away while setting up the gazebo./Tenez les enfants et les animaux à l'écart de l'abri de jardin pendant son assemblage.
- Check all nuts and bolts periodically to ensure they are tightened./ Assurez-vous périodiquement que tous les écrous et boulons pour s'assurer que les ils sont serrés.
- Snow must be cleared off regularly during snowy days. Remove the snow at the roof top when it is thicker than 2 inches. In order to avoid damage, use a plastic snow rake to remove excessive snow and ice buildup from roof and keep away from falling debris. and removal of fallen debris. /La neige doit être déblayée régulièrement pendant les jours de neige. Enlevez la neige sur le toit lorsqu'elle est plus épaisse que 2 pouces. Afin d'éviter tout dommage, utilisez un râteau à neige en plastique pour enlever l'accumulation excessive de neige et de glace sur le toit et éloignez-vous des chutes de débris. et l'enlèvement des débris tombés.
- This gazebo is intended for decorative and sunshade purposes only and is not designed to withstand harsh weather, including high winds, rain, and snow. / Cet abri de jardin est conçu uniquement pour des fins décoratives et de pare-soleil, et il n'est pas conçu pour résister aux intempéries, notamment les vents violents, la pluie et la neige.
- If any scratches in paint occur, please touch up to prevent rustin / En cas de rayures sur la peinture, veuillez les retoucher pour éviter la rouille.

Important:

- Please read and understand this manual before any assembly. Before beginning assembly of product, make sure all parts are present. Compare parts with packaging contents list.
 - When assembling wooden parts, do not overtorque the bolts to avoid splitting the wood. See image illustration.
 - Place all parts from the box in a cleared area and position them on the floor in front of you.
 - Remove all packing materials and place them back into the box. Do not dispose of the packing materials until assembly is complete.
 - Read each step carefully before beginning any assembly and make sure you understand each step. If you are missing a part, please email customer.care@sunjoygroup.com.
 - Needed for assembly: (The following tools are not included)
-
- Veuillez lire et bien comprendre ce guide avant de procéder à l'assemblage. Avant de procéder à l'assemblage du produit, assurez-vous que toutes les pièces sont présentes.
 - Lors de l'assemblage de pièces en bois, ne serrez pas trop les boulons afin d'éviter de fendre le bois.
 - Consultez l'illustration dans les schémas. Mettez toutes les pièces de la boîte dans une zone dégagée et positionnez-les sur le sol devant vous.
 - Retirez tous les matériels d'emballage et remettez-les dans la boîte. Ne les jetez pas avant d'avoir terminé l'assemblage.
 - Lisez chaque étape attentivement avant de commencer à assembler et assurez-vous de comprendre bien chaque étape. S'il vous manque des pièces, veuillez envoyer un email à customer.care@sunjoygroup.com.
 - Nécessaire pour l'assemblage : (les outils suivants ne sont pas inclus).



This identifies information that requires special attention. Improper assembly could lead to an unsafe or dangerous condition. / Cette icône identifie de l'information. Utilisez un niveau / Vérifiez avec un équerre / Serrer les boulons / Mesurer la distance



Use Level/Utilisez un niveau

Check that set or assembly is properly level before proceeding / Vérifiez que l'assemblage est d'aplomb avant de procéder à la prochaine étape.

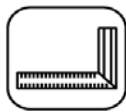

Square Assembly/Vérifiez avec un équerre

Check that assembly is square before tightening bolts. / Vérifiez que l'assemblage est carré avant de serrer les boulons.

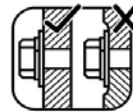

Tighten Bolts/Serrer les boulons

Do not overtorque mounting bolts. Over-tightening may cause the wood to crack creating splinters and other structural damage. / Ne serrez pas trop les boulons de fixation. Un serrage excessif peut provoquer des fissures dans le bois, créant des éclats de bois et d'autres dommages structurels.



Measure Distance/Mesurer la distance

**Installation blueprint/
Plan d'installation**

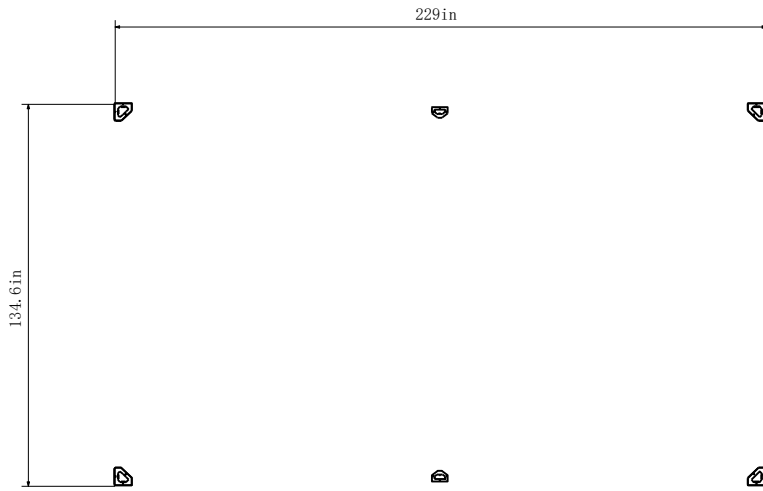



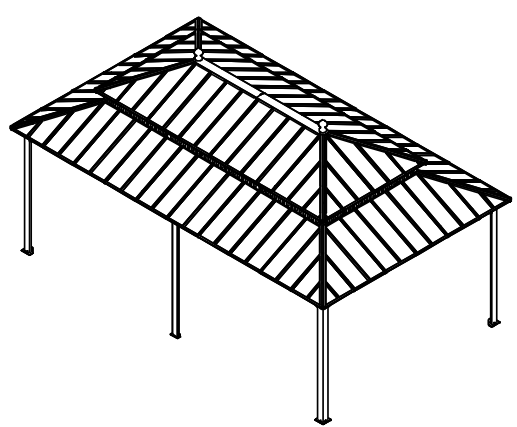
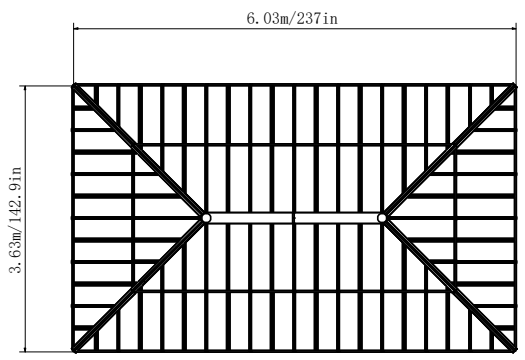
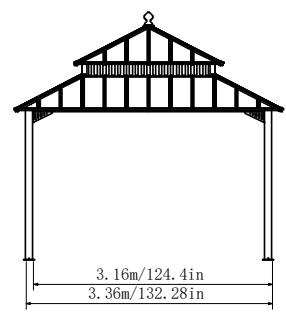
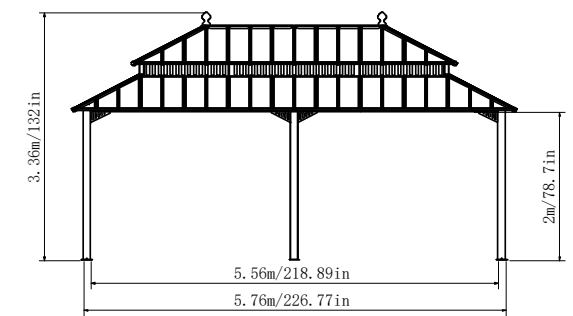



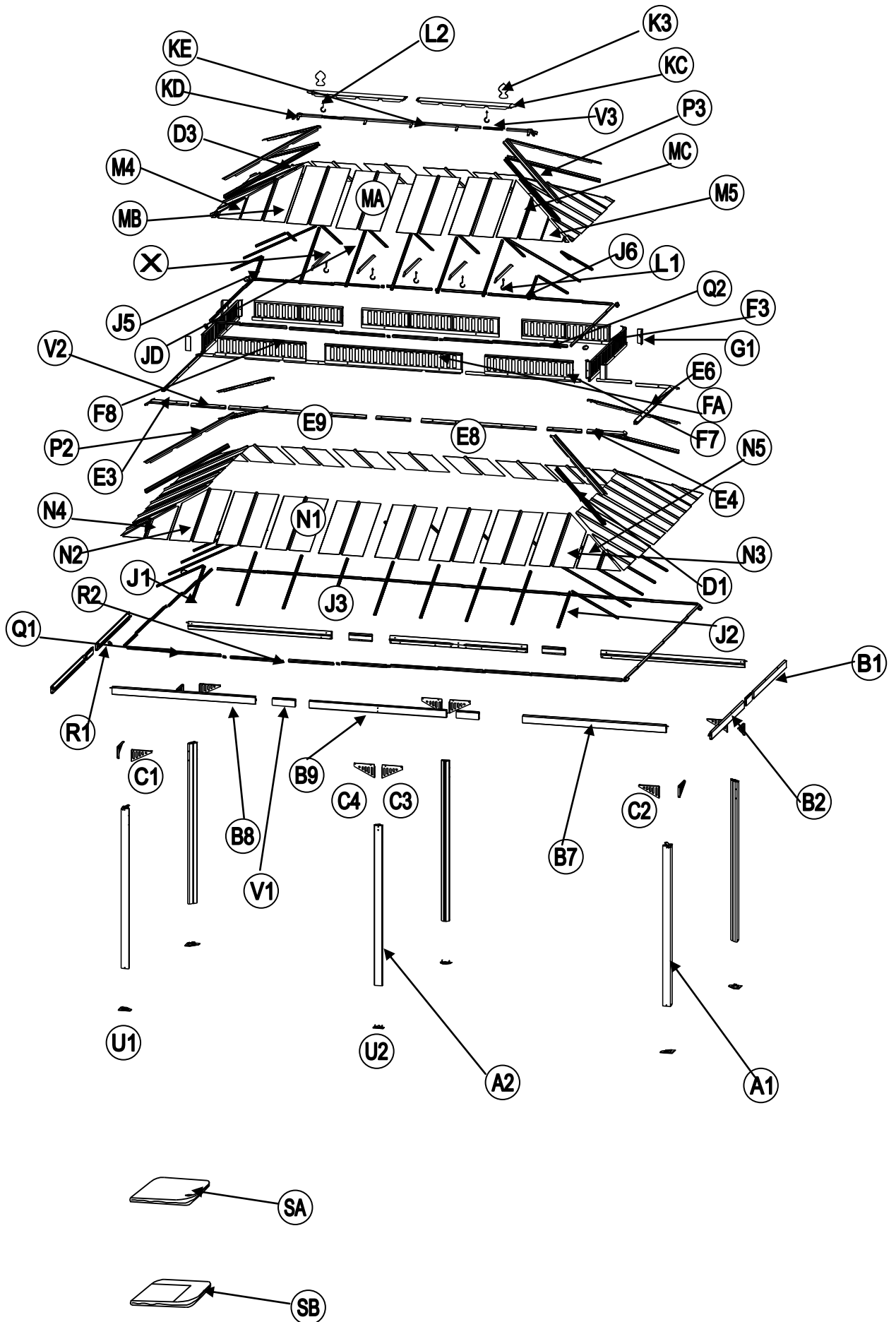









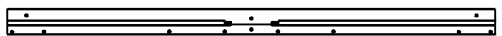
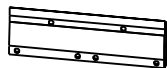



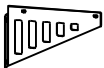



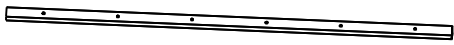

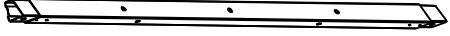





**Product size effect drawing/
Dessin d'effet de taille de
produit**

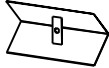

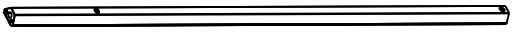
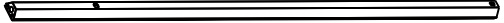

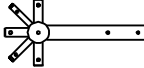

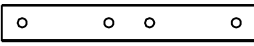

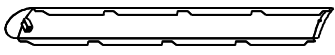











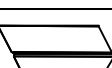



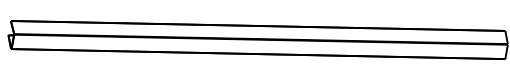
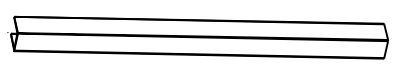
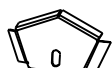

EXPLODED DRAWING/ DESSIN ÉCLATÉ

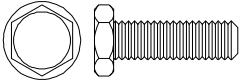

Parts List/Liste de Pièces				
Label Étiquette	Part Number Numéro de la Pièce	Description	Qty Quantité	Part Image/Numéro de la Pièce Diagramme
A1	P00020104502	Post/Poteau	4	
A2	P00020105002	Post(Middle)/Poteau (milieu)	2	
U1	P00010065202	Post Base/Base du Poteau	4	
U2	P00010065802	Post Base(Middle)/Base du Poteau(milieu)	2	
B7	P00040195702	Long Cross Beam 1/ Traverse Longue 1	2	
B8	P00040195802	Long Cross Beam 2/ Traverse Longue 2	2	
B1	P00040194302	Short Cross Beam 1/ Traverse courte 1	2	
B2	P00040194402	Short Cross Beam 2/ Traverse courte 2	2	
B9	P00040196502	Long Cross Beam (Middle)/ Traverse Longue (milieu)	2	
V1	P00050258502	Cross Beam Connector/ Connexion de la Traverse	6	
C1	P00500104702	Triangle Supportor 1/ Triangle Supportor 1	4	
C2	P00500104802	Triangle Supportor 2/ Triangle Supportor 2	4	
C3	P00500106202	Triangle Supportor(Middle) 1/Triangle Supportor (milieu)1	2	
C4	P00500106302	Triangle Supportor(Middle) 2/Triangle Supportor (milieu)2	2	
D1	P00060345302	Big Roof Rafter/Chevron du Grand Toit	4	
D3	P00060348002	Small Roof Rafter/ Petit chevron de toit	4	
E8	P00060349702	Big Roof Long Frame(short)/Grand toit Long cadre(court)	2	
E9	P00050261702	Big Roof Long Frame(long)/ Grand toit Long cadre(long)	2	

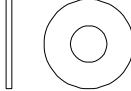
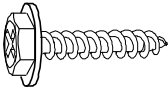
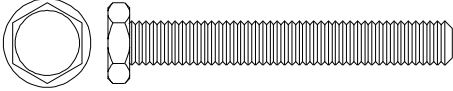
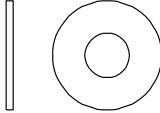
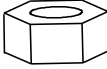
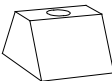
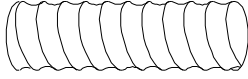
E6	P00060348302	Big Roof Short Frame/ Structure Courte du Grand Toit	2	
E3	P00050258602	Big Roof Corner 1/Angle du Grand Toit 1	2	
E4	P00050258702	Big Roof Corner 2/Angle du Grand Toit 2	2	
V2	P00050258802	Big Roof Frame Connector/ Connecteur de cadre de toit Big Roof	6	
F3	P00630021302	Short side screen/ Écran latéral court	2	
F7	P00630021702	Long-sided screen 1/ Écran latéral long 1	2	
F8	P00630021802	Long-sided screen 2/ Écran latéral long 2	2	
FA	P00630022002	Long-sided screen (middle)/Écran latéral long (milieu)	2	
G1	P00560067202	Decoration /Ornement	4	
J1	P00060345802	Big Roof Short Middle Beam(Left)/Grand toit Courte poutre centrale (Gauche)	4	
J2	P00060345902	Big Roof Short Middle Beam(Right)/Grand toit Courte poutre centrale (Droite)	4	
J3	P00060345702	Big Roof Middle Beam (Middle) /Poutre Centrale du Grand Toit(Centre)	20	
JD	P00060350002	Small Roof Middle Beam (Middle)/Poutre Centrale du Petit Toit (Centre)	12	
J5	P00060346102	Small Roof Left short Middle Beam /Petit toit Court gauche Poutre du milieu	4	
J6	P00060346202	Small Roof Right short Middle Beam/ Petit toit Court droit Poutre centrale	4	
KD	P00050261402	Small Roof Connector/ Connexion du petit toit	2	
KE	P00050261502	Small Roof Connector(Middle)/ Connexion du petit toit(milieu)	1	
V3	P00050261802	Small Roof Connector Accessories/Accessoires pour petits connecteurs de toit	2	
X	P00050261602	Small Roof Middle Connector/Petit toit Connecteur intermédiaire	5	
KC	P00090026202	Small Roof Cap/ Capuchon du Petit Toit	2	

K3	P00100004202	Finial/Épi de faitage	2	
L1	P00580015401	Hook /Crochet	5	
L2	P00580020502	Small Hook/Petit crochet	2	
MA	P00070176702	Small Roof Middle Roof Panel/Petite toiture Panneau de toiture intermédiaire	8	
MB	P00070176502	Small Roof Left Middle Roof Panel /Petite toiture Panneau central gauche de la toiture	4	
MC	P00070176602	Small Roof Right Middle Roof Panel /Petit panneau de toit droit Panneau de toit central	4	
M4	P00070174802	Small Roof Left Small Roof Panel /Petit toit gauche Petit panneau de toit	4	
M5	P00070174902	Small Roof Right Small Roof Panel /Petit toit droit Petit panneau de toit	4	
N1	P00070175002	Big Roof Middle Roof Panel /Panneau du Toit Central du Grand Toit	16	
N2	P00070175102	Big Roof Left Middle Roof Panel /Panneau de Toiture Central Gauche du Grand Toit	4	
N3	P00070175202	Big Roof Right Middle Roof Panel /Panneau de Toiture Central Droit du Grand Toit	4	
N4	P00070175302	Big Roof Left Small Roof Panel /Panneau de Petite Toiture Gauche du Grand Toit	4	
N5	P00070175402	Big Roof Right Small Roof Panel /Panneau de Toiture Petit Droit du Grand Toit	4	
P3	P00080055502	Small Roof Rafter Cap/ Capuchon du Chevron du Petit Toit	4	
P2	P00080055002	Big Roof Rafter Cap/ Chevron du Grand Toit	4	
Q1	P00220059502	U Shape Beam Cap 1/ Capuchon de poutre en forme de U 1	48	
Q2	P00220059602	U Shape Beam Cap 2/ Capuchon de poutre en forme de U 2	8	
R1	P00220060302	Corner Cap/ Capuchon d'Angle	8	
R2	P00220060402	Fixed Part /Partie fixe	48	
SA	P00130019202	Curtain/Rideau	1	
SB	P00120036102	Mosquito Netting/ Filet moustiquaire	1	

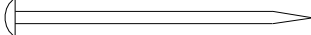
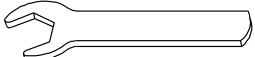
Hardware Pack/Pack Quincaillerie					
Label/ Étiquette	Part Number/ Numéro de la Pièce	Description	Qty/ Quantité	Add	Part Imag/Numéro de la PièceDiagrammee
H1	H010010087	Bolt M6*20/ Boulon M6*20	192	12	
H2	H010010004	Bolt M6*35/ Boulon M6*35	105	5	
H3	H050030001	Flat washer M6/Rondelle Plate M6	297	15	
H4	H100100001	Screws ST5.8x20 / Vis ST5.8x20	56	3	
H11	H010010184	Bolt M8*40/ Boulon M8*40	4	1	
H12	H050050005	Flat washer M8/Rondelle Plate M8	4	1	
H5	H040010004	Hex Nut M6/ Écrou hexagonal M6	28	2	
H6	H990020020	Rubber Washer/Rondell en Caoutchouc	17	1	
H7	H020050004	Thread Stud M6*25/Goujon fileté M6x25	18	1	
H8	H990020022	Connector M6/ Connecteur M6	18	1	
H9	H990060036	Plastic Plug/ Bouchon en plastique	12	1	
H10	H990040022	Adjust Nut M6/ Écrou de réglage M6	18	1	
HR	H990050009	Plastic Ring/ Anneau en plastique	152	10	
HS	H070010003	Stake Φ 8*180/ Piquet Φ 8*180	12	0	
HW	H090010017	Wrench M6/ Clé M6	2	0	

1

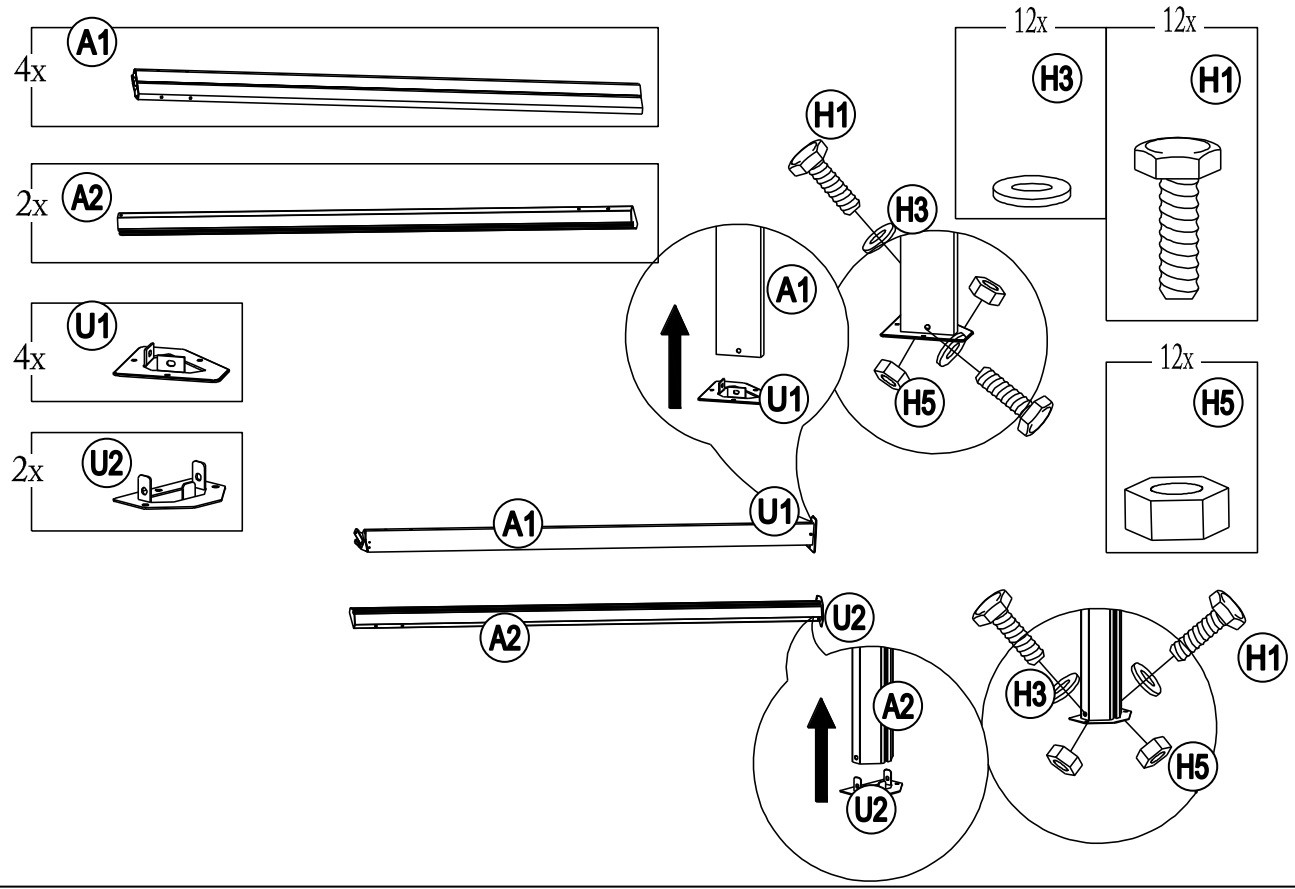

2

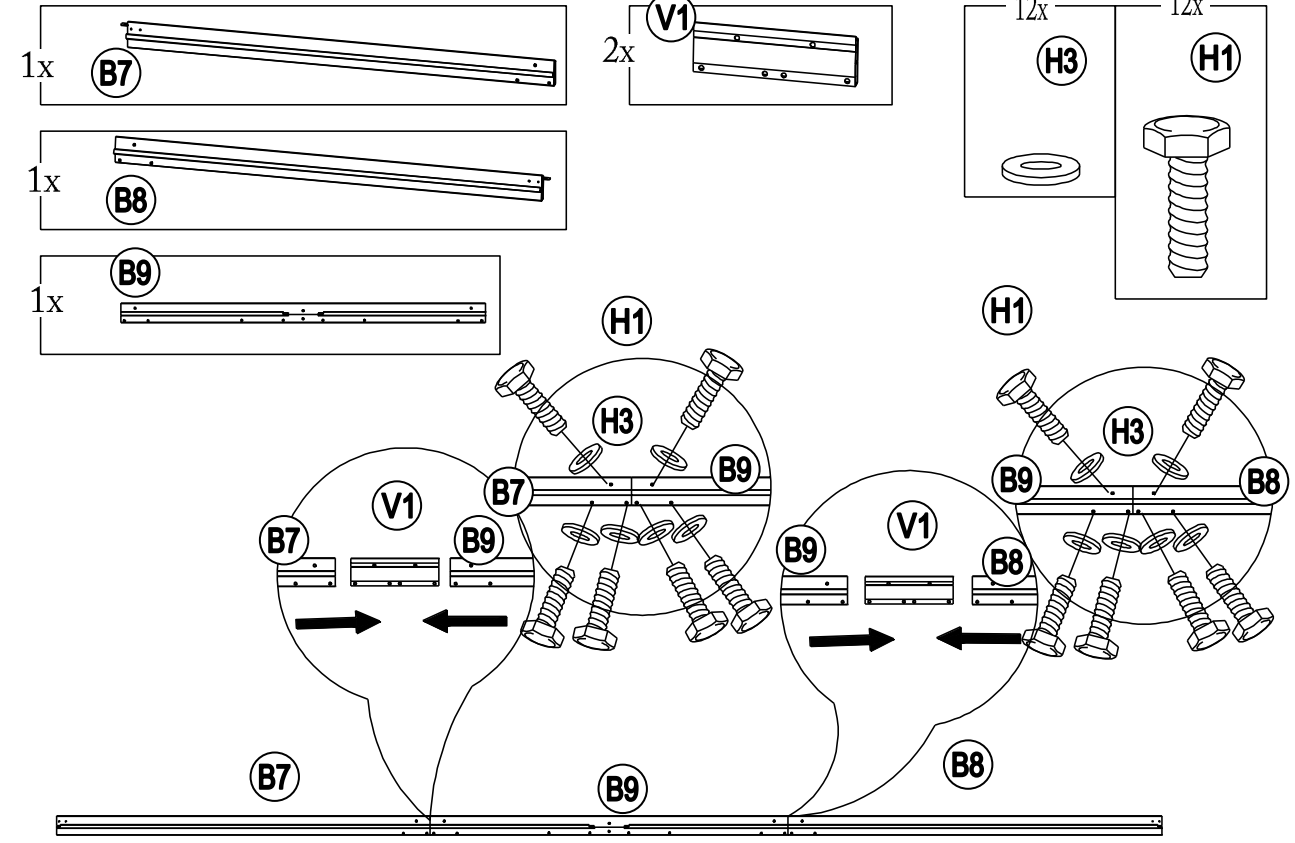

5

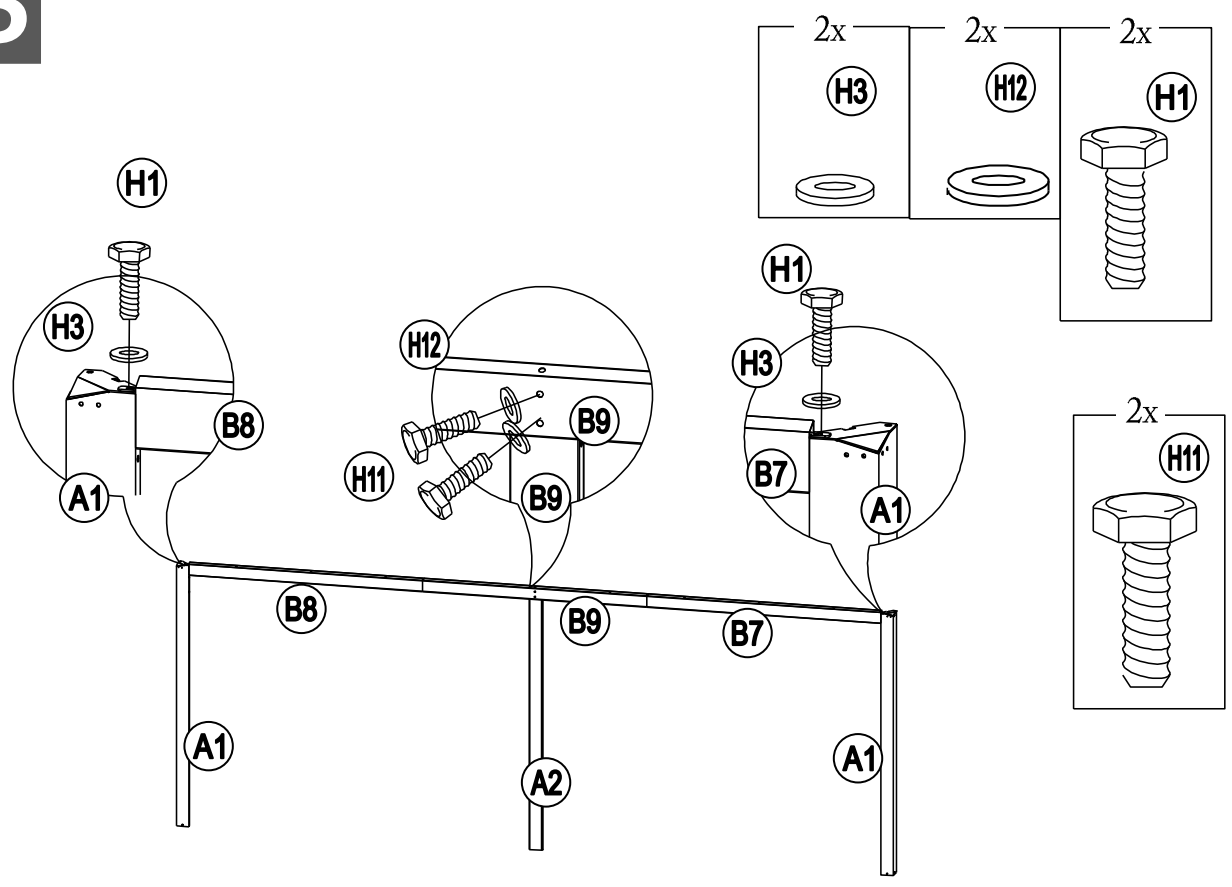

6

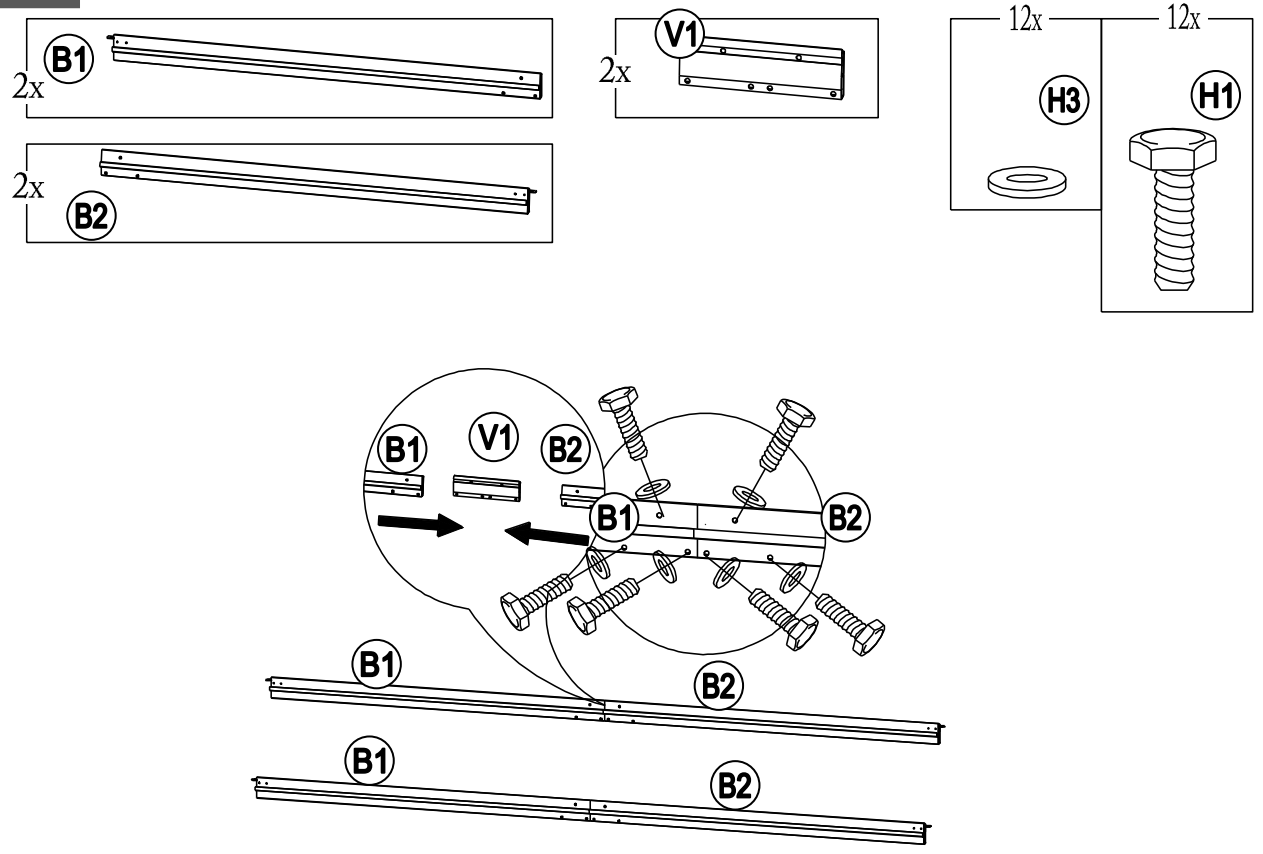

7

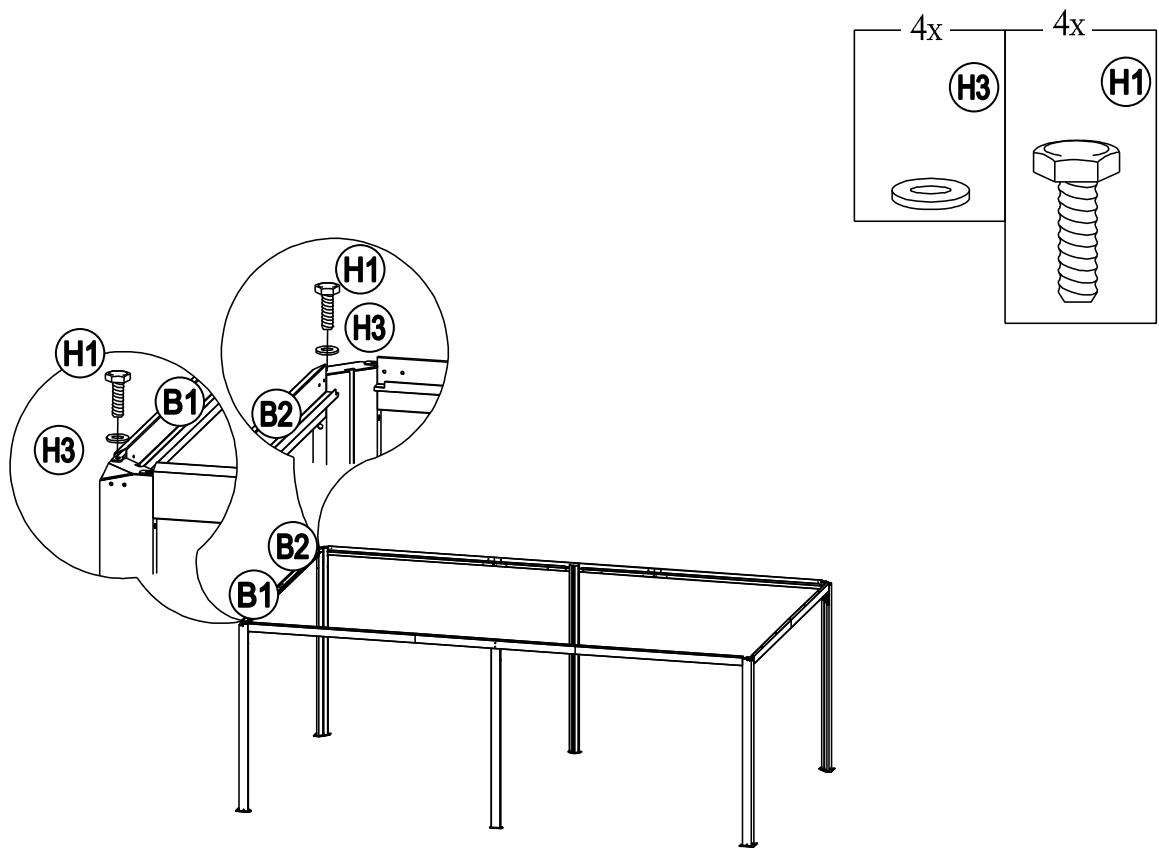

8

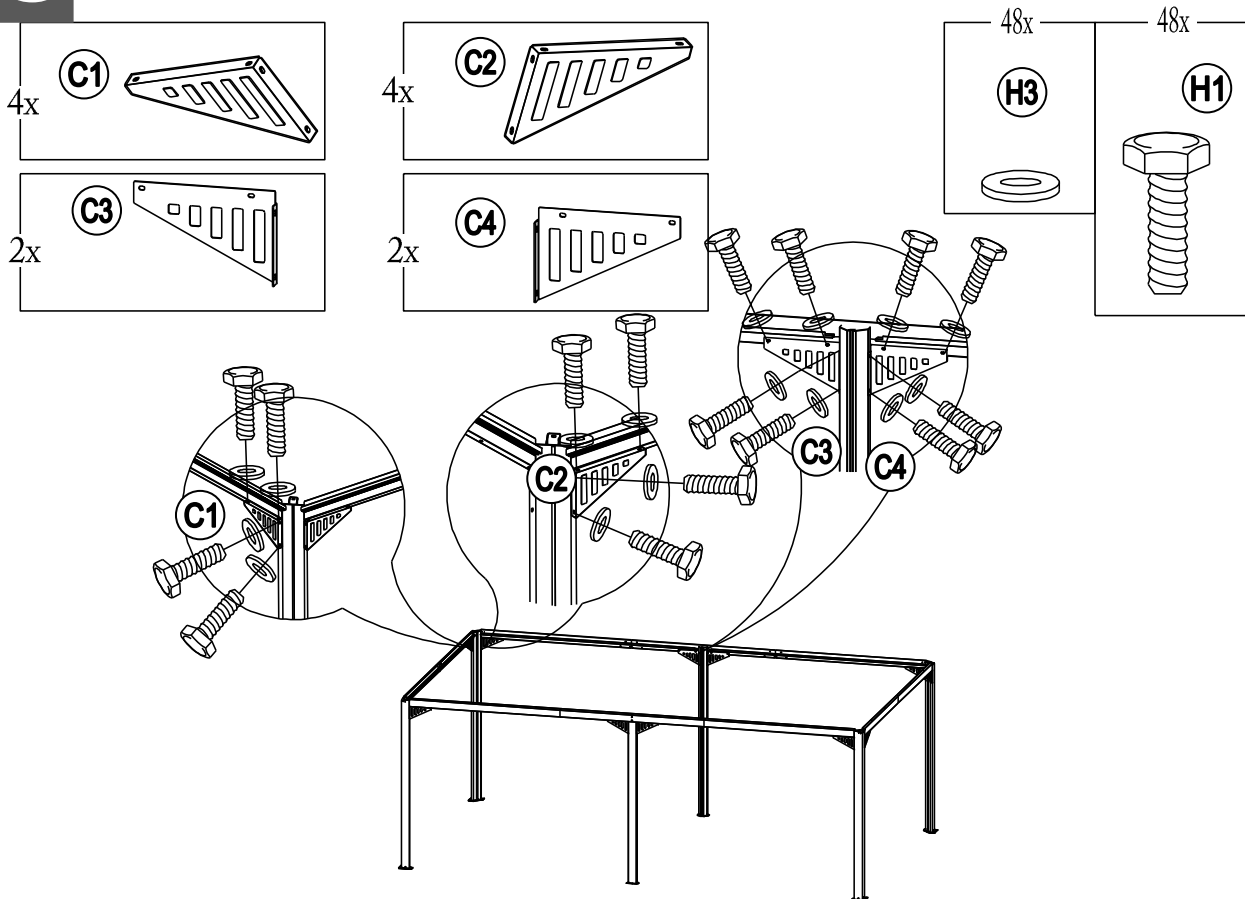

9

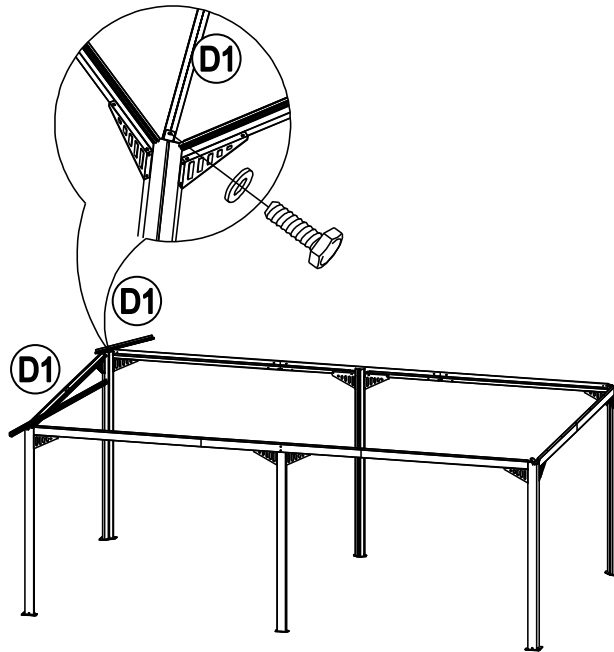
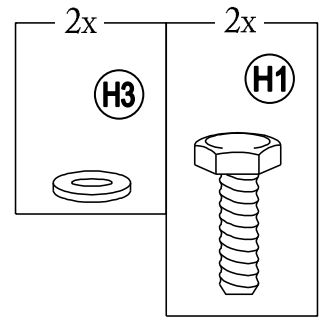
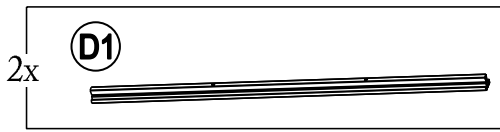

10

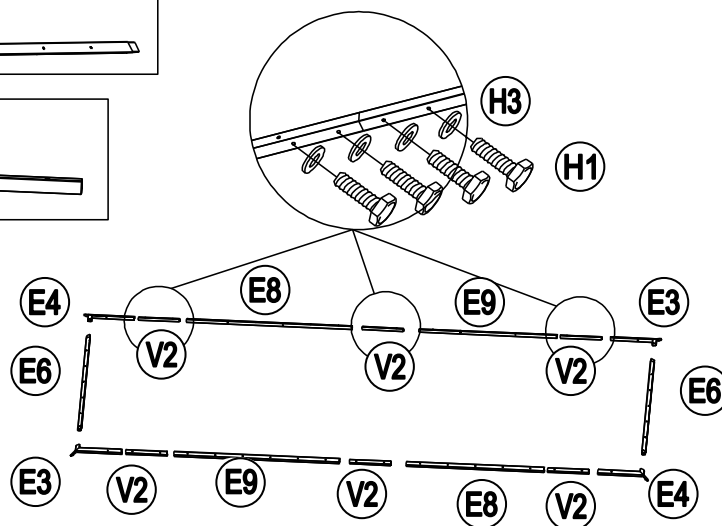
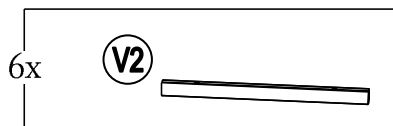
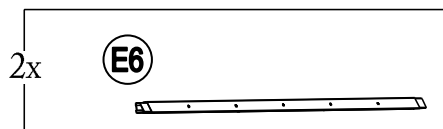
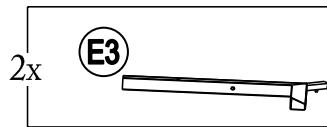
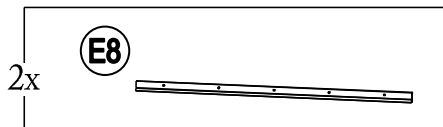
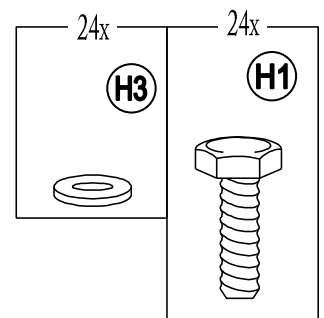
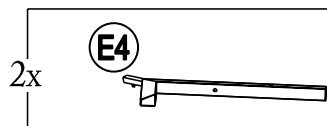
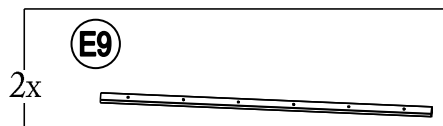

11

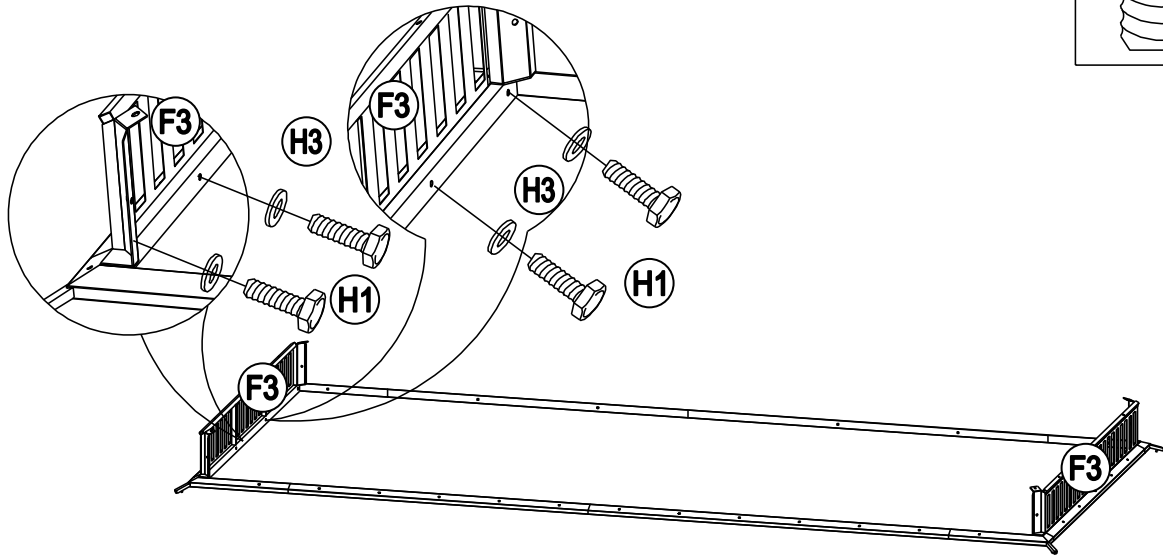
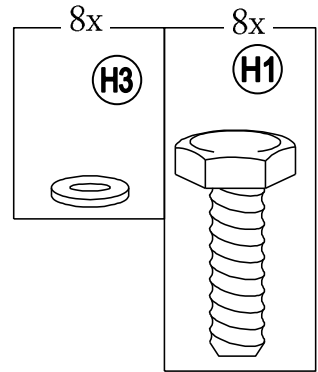
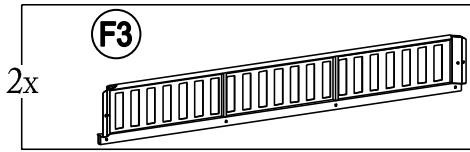

12

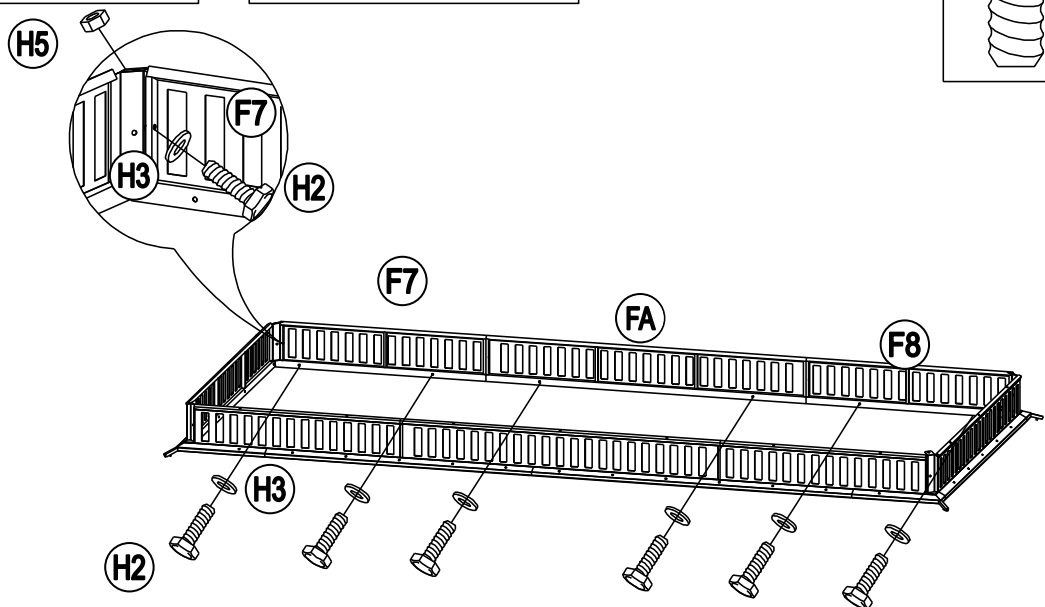
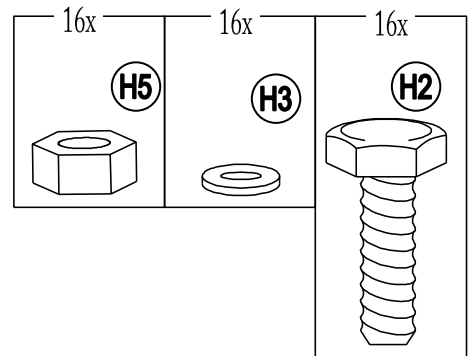
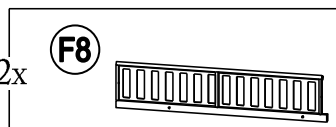
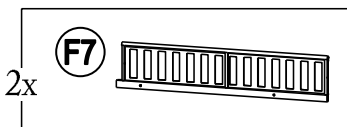
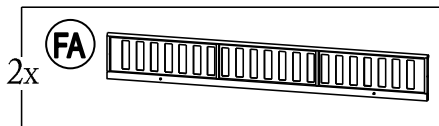

13

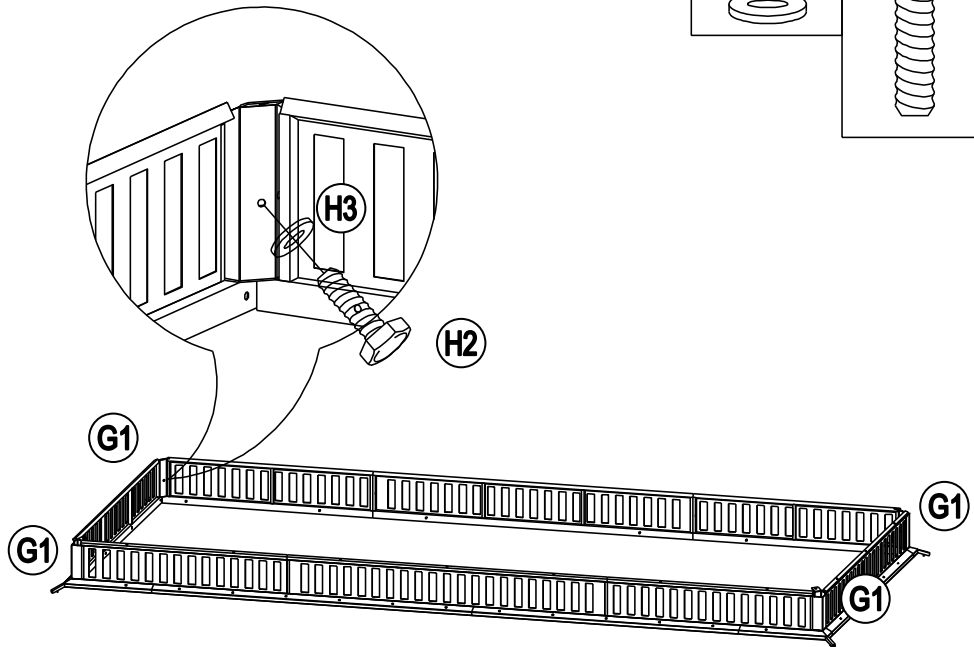
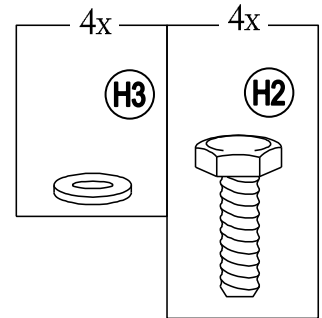
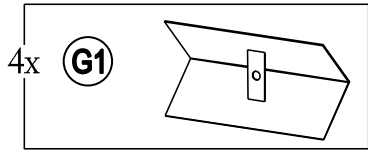

14

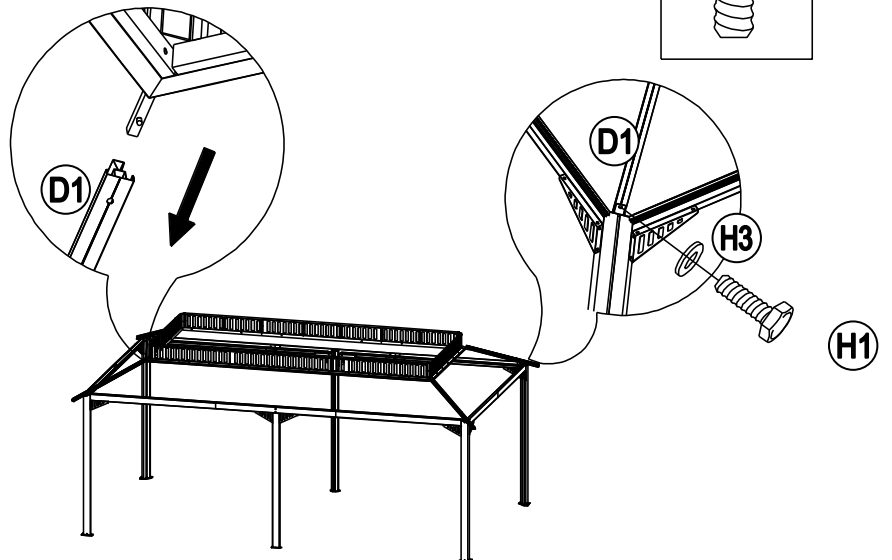
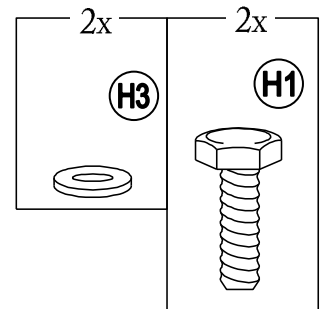
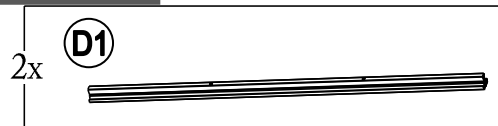

15

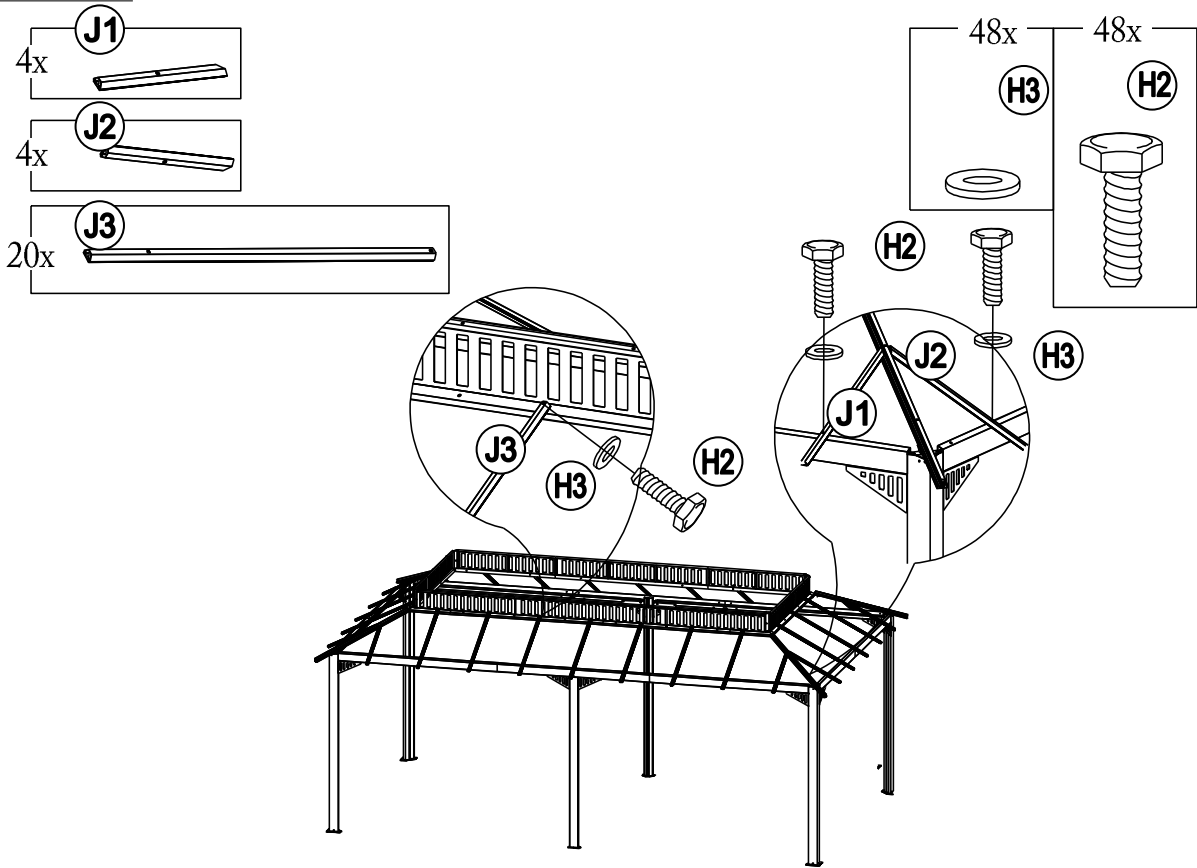

16

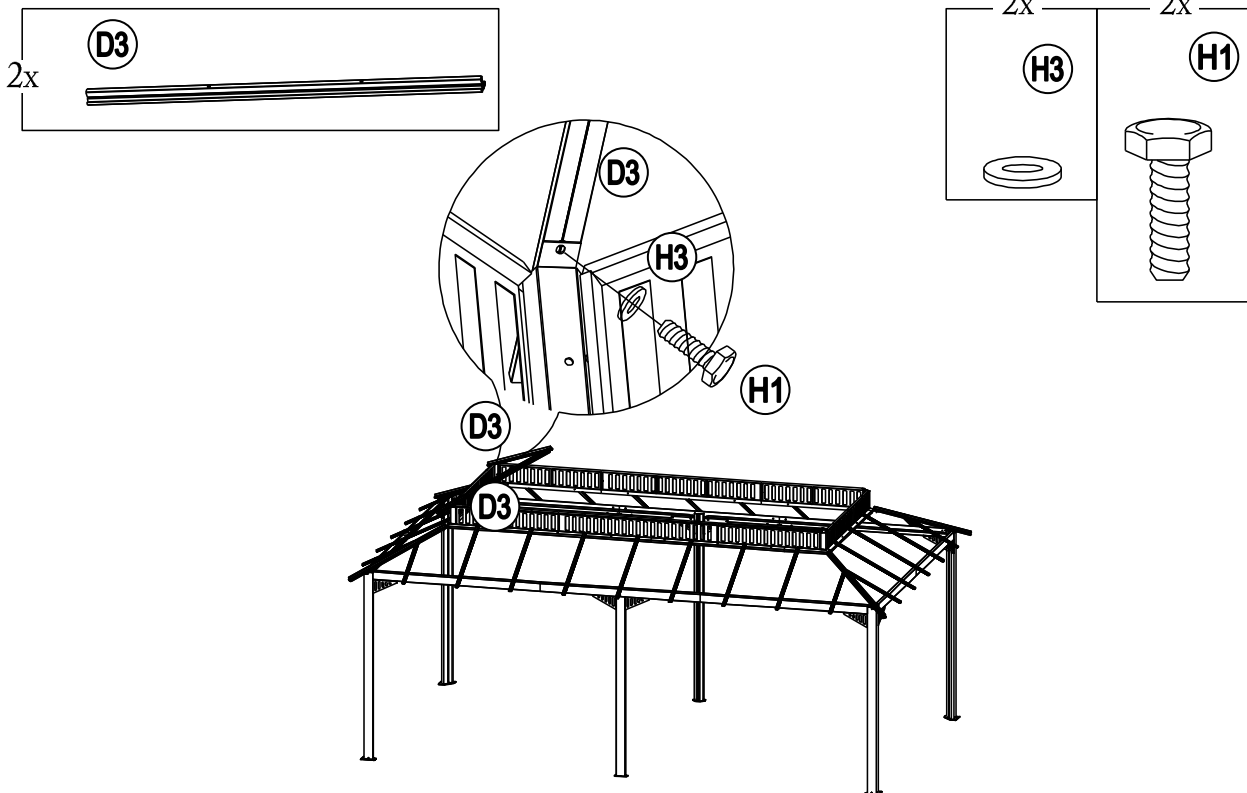

17

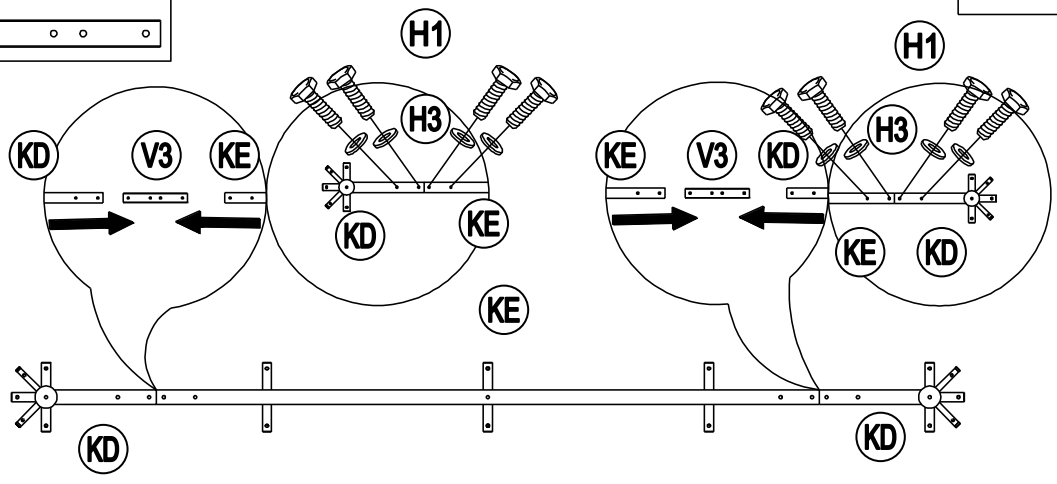
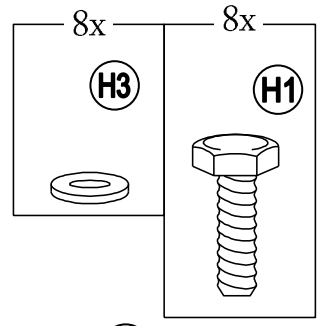
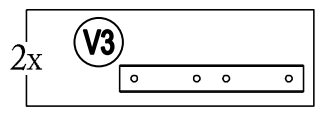
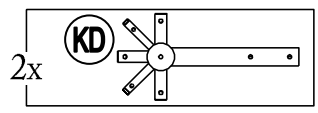
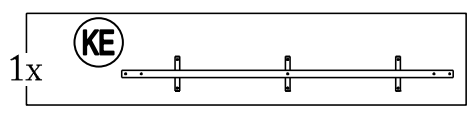

18

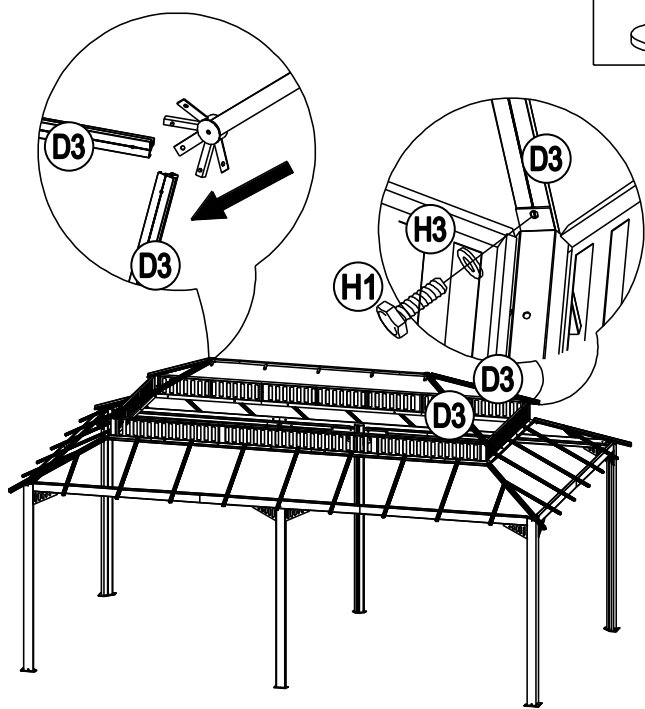
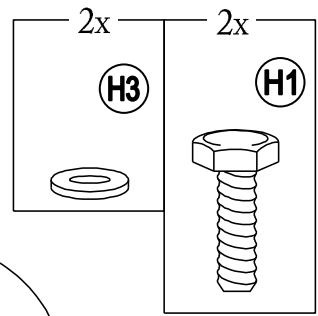
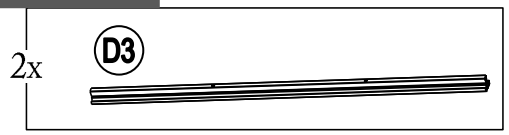

19

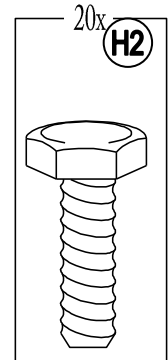
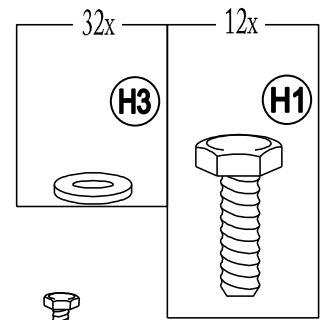
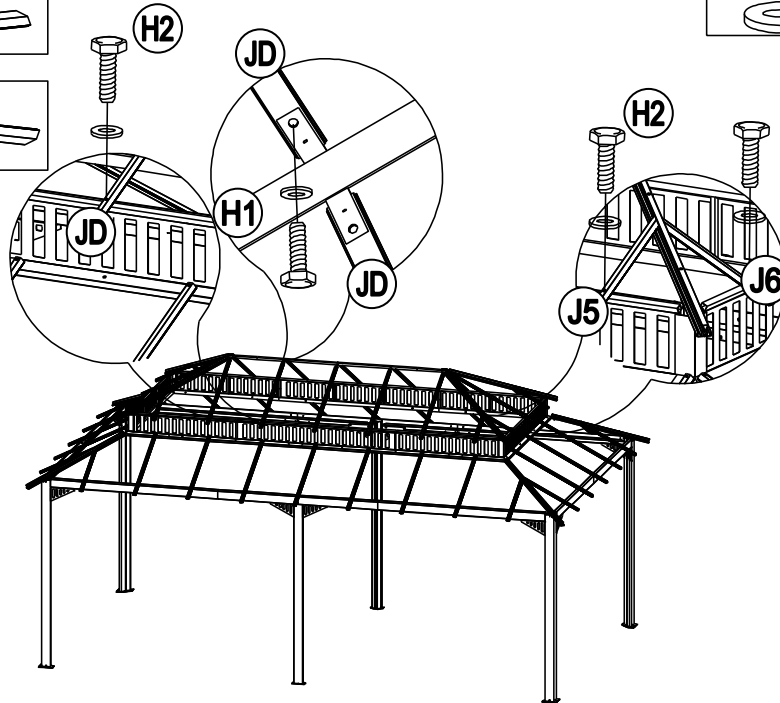
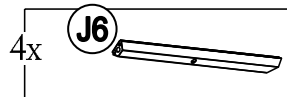
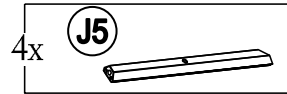

20

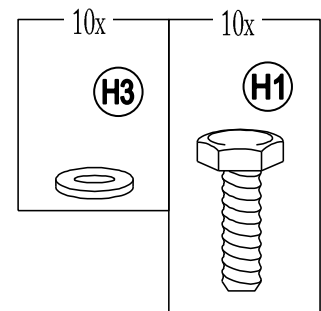
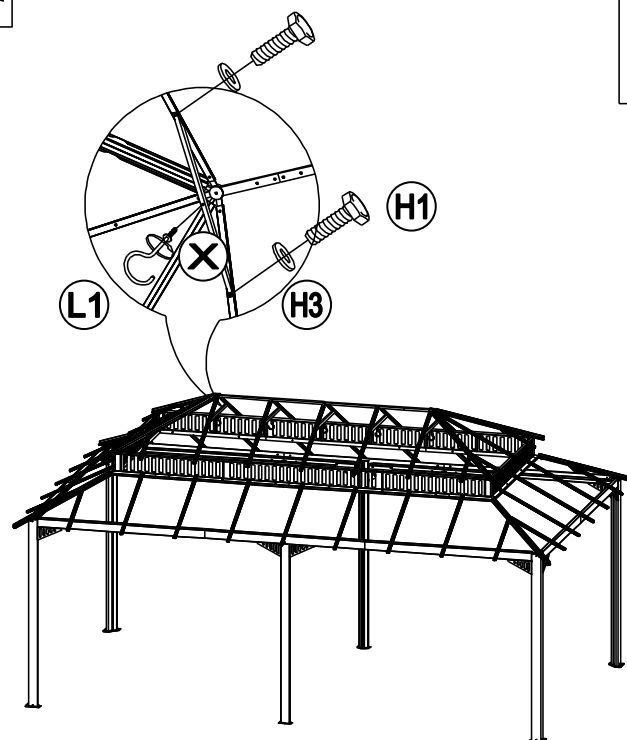
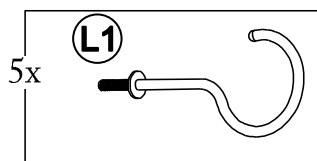

21

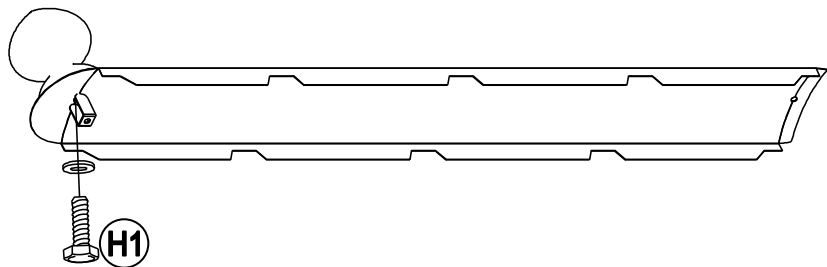
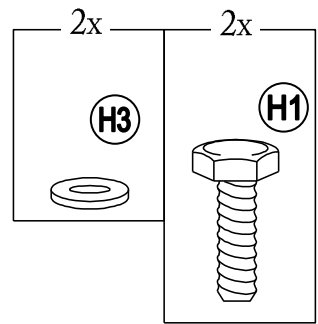
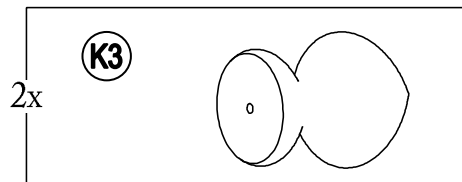
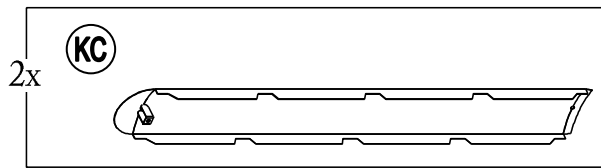

22

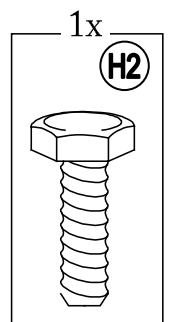
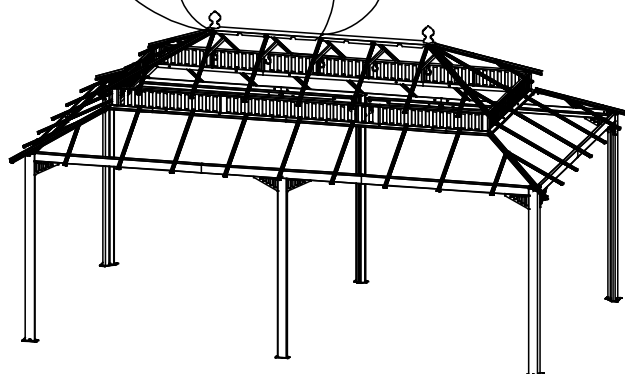
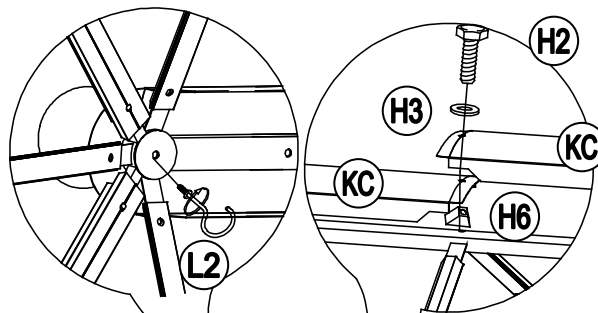
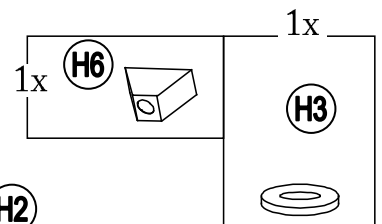
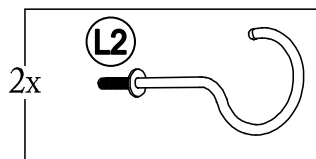

23

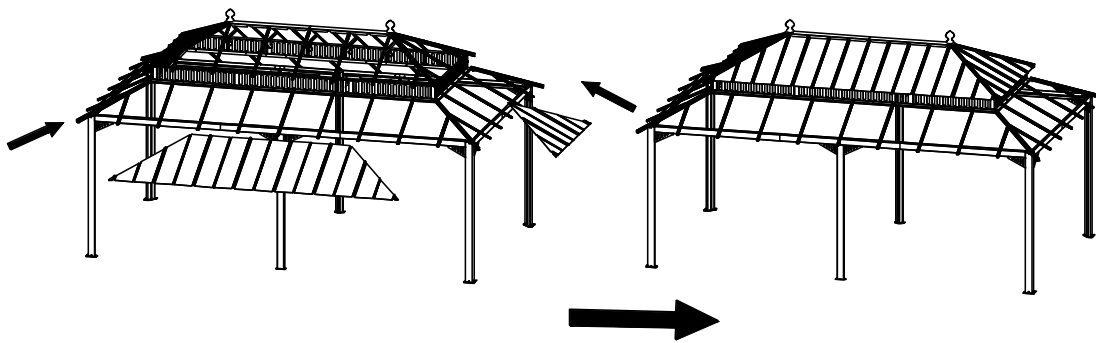
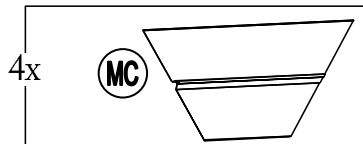
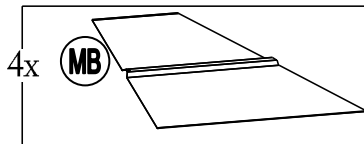
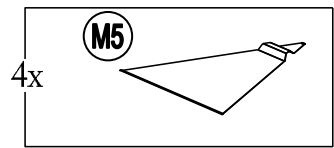
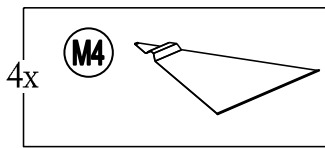
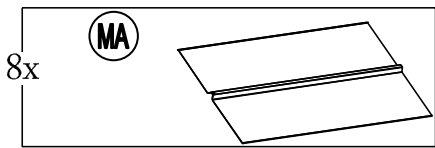

24

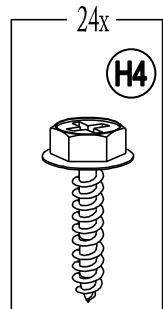
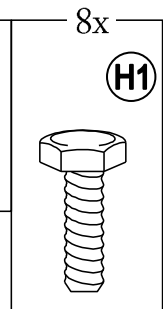
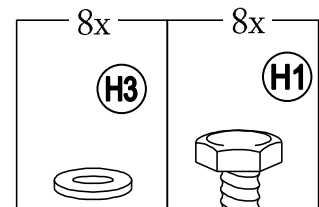
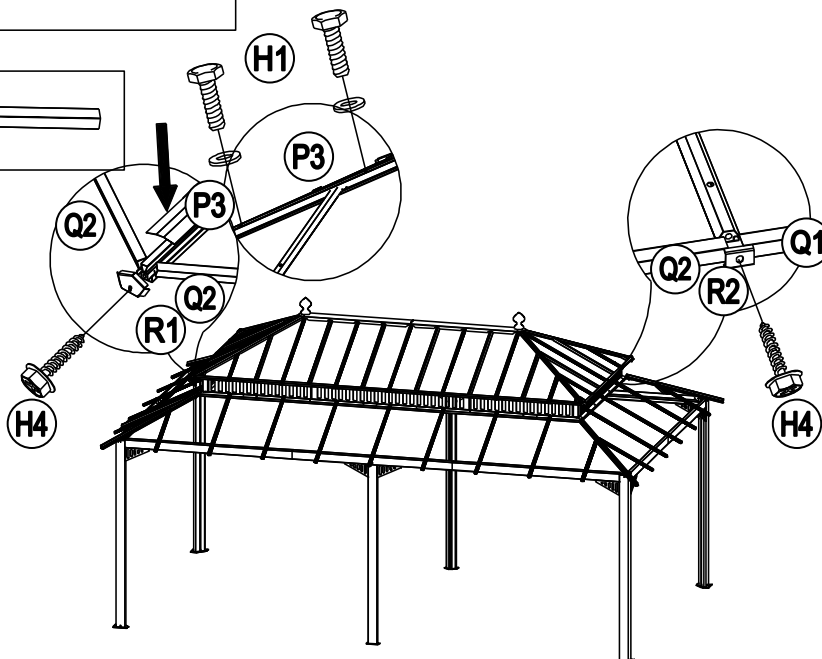
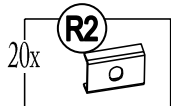
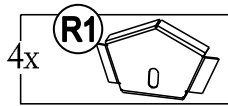
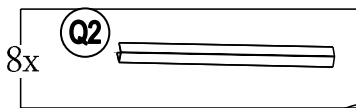
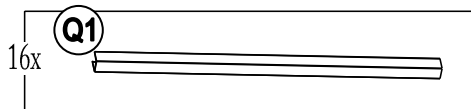
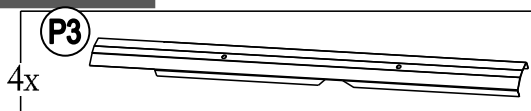

25

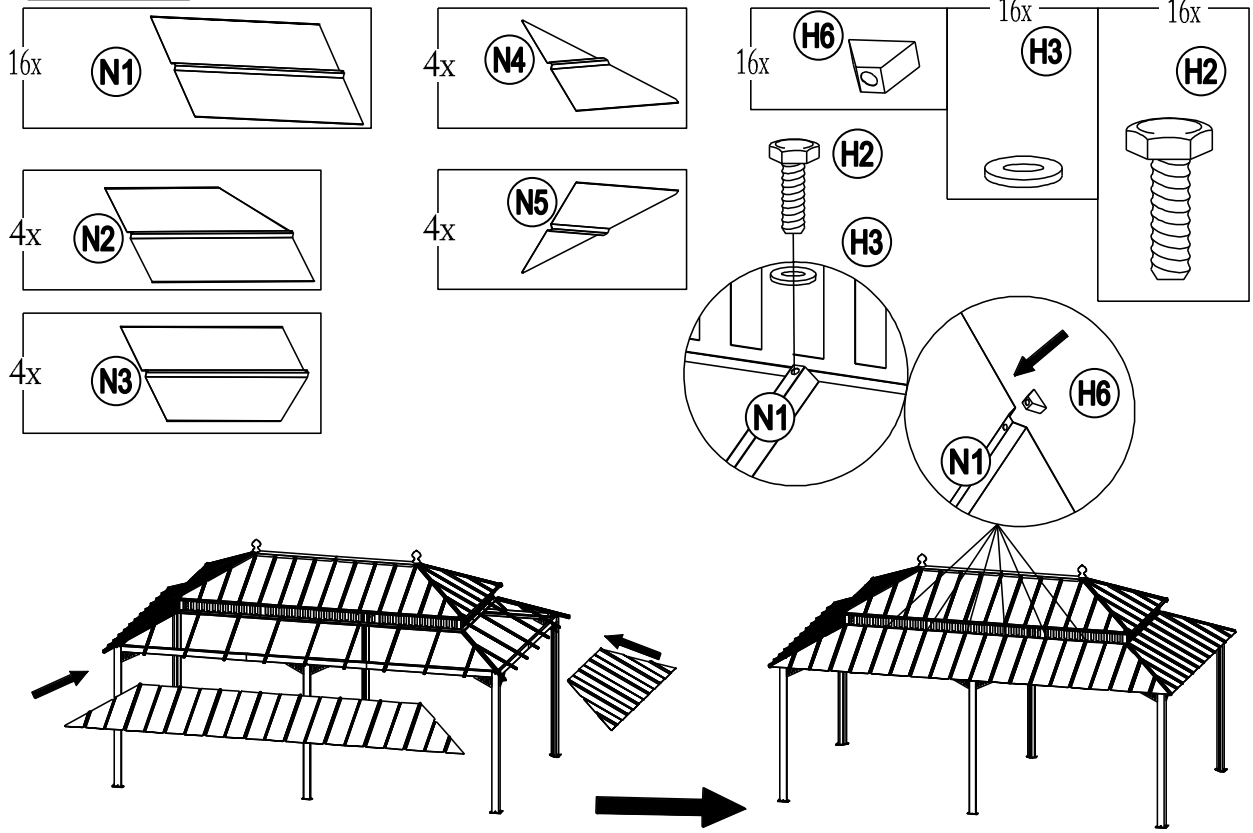

26

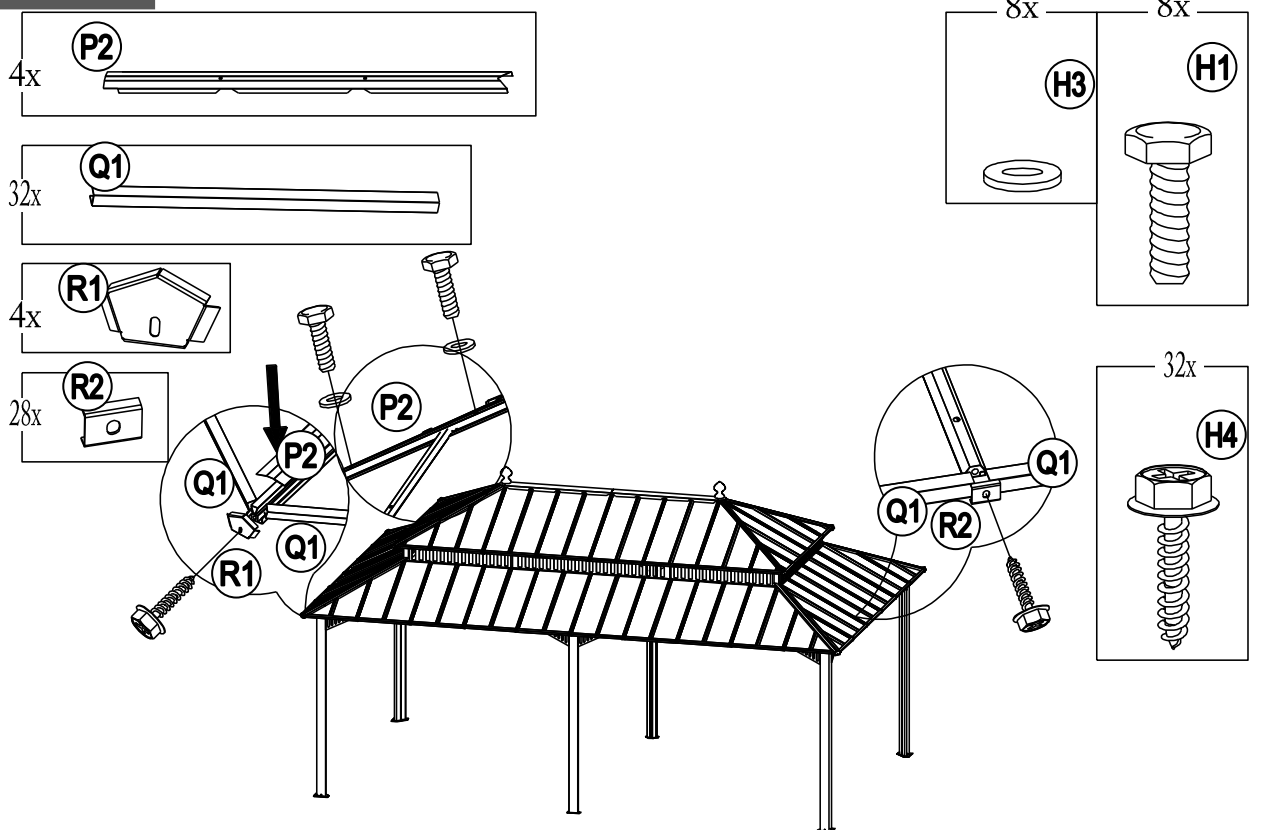

27

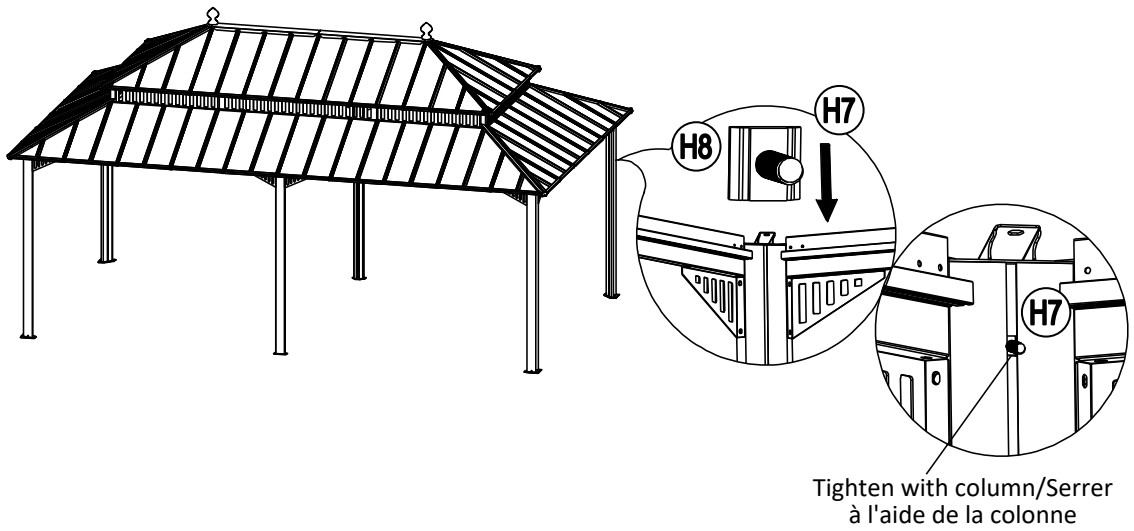
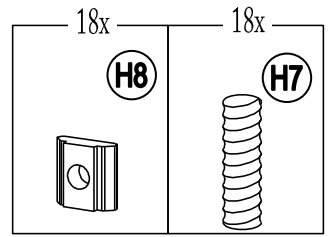

28

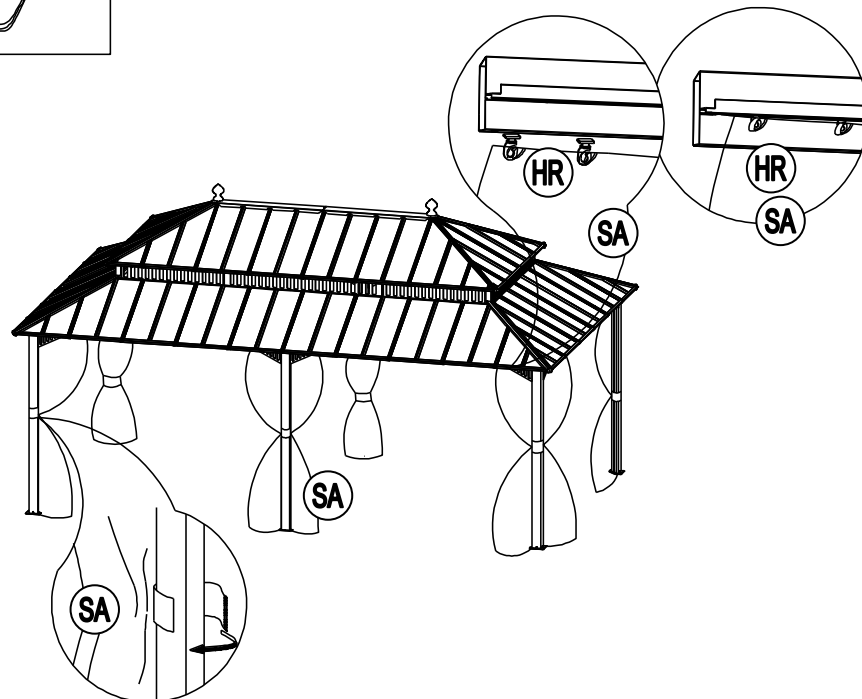
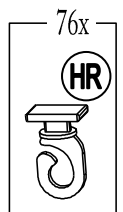
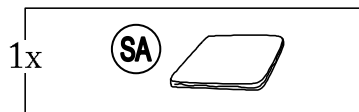

29

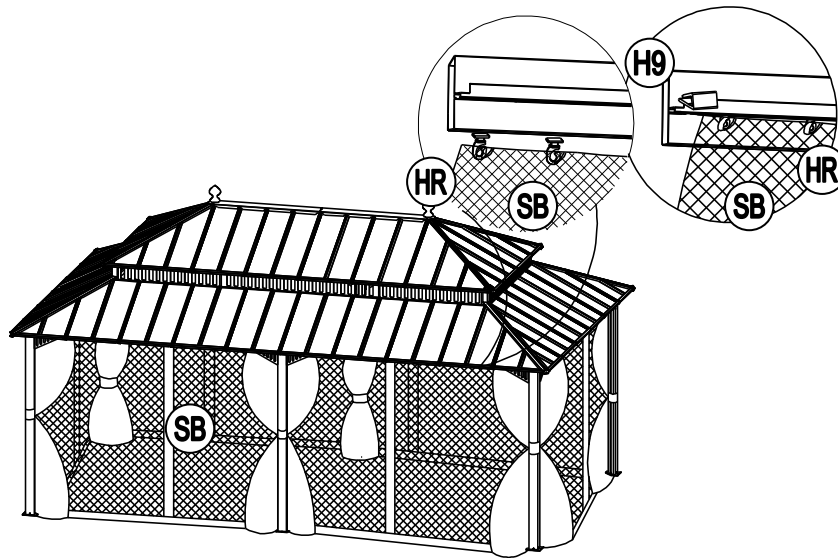
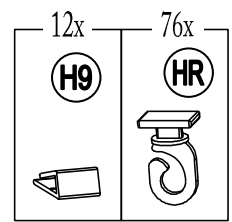
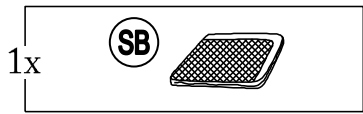

30

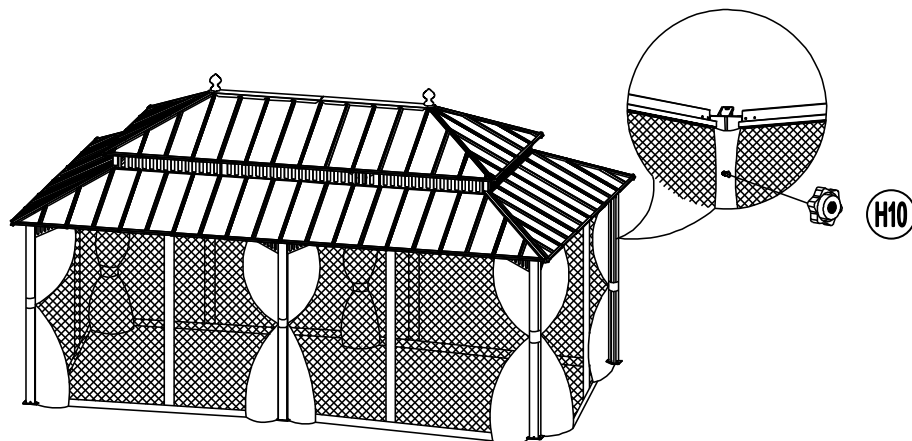
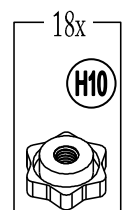

31

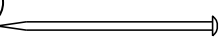
12x  

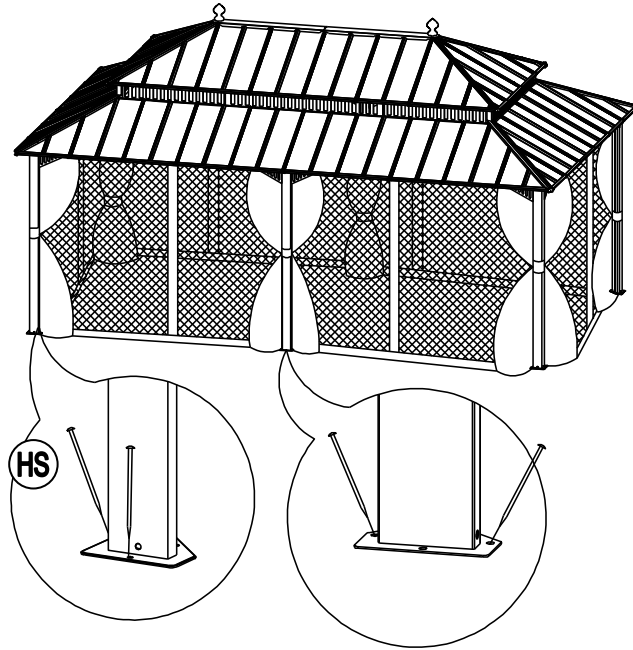

Maintenance

- Steel components for this gazebo are treated with rust inhibiting paint . However, due to the nature of steel, surface oxidation (rusting) will occur if these protective coatings are scratched. This is not a defect and thus not covered by the warranty.
- To minimize this condition, it is recommended to use care when assembling and handling the product to prevent scratching the paint. Should any scratching or damage occur, it is recommended to cover the scratch immediately with rust inhibiting resistant paint (not included).
- Surface rust can also be easily removed with a very light application of regular cooking oil or WD-40. If surface oxidation (rusting) occurs and if no measure is taken to prevent this, the oxidation may start dripping onto deck or patio and caused damaging stains, which may be difficult to remove. This can be prevented if the above-mentioned measures are taken to keep the product from oxidizing.
- Do not use bleach, acid, or other abrasive cleaners on the roof or frame parts.
- Keep instruction manual for future reference.
- Keep the original packaging to store the gazebo.
- Periodically check and ensure that all bolts are well-tighten during use.

Limited Manufacturer's Warranty

Sunjoy Group warrants to the original purchaser that this item is free from defects in workmanship and materials for a period of 1 year from the date of purchase, provided the item was factory-sealed at the time of purchase and is maintained with care and used only for personal, residential purposes. Should any manufacturing defect arise within this warranty period, Sunjoy Group will replace (at our option) any defective merchandise or parts upon proof of purchase; however, transportation and delivery costs, as well as payments to a third party for assembly or disassembly of the item, remain the responsibility of the purchaser. A purchaser of an "open box," previously-returned, or "clearance" item, as well as original purchasers outside of the warranty period, may obtain replacement parts from Sunjoy Group for products in current production, at nominal cost.

Exclusions

Items used for commercial, contract, or other non-residential purposes, or items damaged due to acts of nature, vandalism, misuse, or improper assembly are not covered. Corrosion or rusting of hardware is not covered.

Proof of purchase (dated register receipt) is required for warranty claims. Warranty is to the original purchaser and is non-transferable. Any replacement of warranted items will be in the original style and color, or a similar style and color if the original is unavailable or has been discontinued. As some states do not allow exclusions or limitations on an implied warranty, the above exclusions and limitations may not apply. This warranty gives you specific rights, and you may also have other rights, which vary from state to state.

Care and Maintenance

- Les composants en acier de ce belvédère sont traités avec une peinture antirouille. Toutefois, en raison de la nature de l'acier, une oxydation de la surface (rouille) se produira si ces revêtements protecteurs sont égratignés. La garantie ne couvre pas ce phénomène puisqu'il ne s'agit pas d'un défaut.
- Afin de minimiser cette situation, nous recommandons d'être prudent lors de l'assemblage et de la manipulation du produit afin d'éviter d'égratigner la peinture. En cas d'égratignure ou de dommage, nous recommandons d'effectuer immédiatement une retouche avec une peinture antirouille.
- La rouille de surface peut facilement être retirée à l'aide d'une petite quantité d'huile de cuisson ordinaire ou de WD-40. Si une oxydation (rouille) de la surface se produit et qu'aucune mesure n'est prise pour corriger la situation, la rouille pourrait couler sur la terrasse et causer des taches dommageables qui peuvent être difficiles à enlever. Cela peut être évité si les mesures mentionnées ci-dessus sont prises pour empêcher l'oxydation du produit.
- N'utilisez pas d'eau de Javel, d'acide ou d'autres nettoyants abrasifs sur le toit ou les pièces du cadre.
- Conservez le manuel d'instructions pour référence future.
- Conservez l'emballage d'origine pour ranger la tonnelle.
- Vérifiez périodiquement pour vous assurer que tous les écrous sont bien serrés pendant l'utilisation.

Garantie limitée du fabricant

Sunjoy Group garantit à l'acheteur initial que ce produit ne présentera aucun défaut de fabrication et de matériaux pendant une période de un an à compter de la date de l'achat si le produit a été acheté dans son emballage scellé à l'usine, et s'il a été entretenu correctement et utilisé à des fins personnelles et résidentielles seulement. Si le produit présente un défaut de fabrication pendant cette période de garantie, Sunjoy Group remplacera (à sa discrétion) toute marchandise ou pièce défectueuse sur présentation d'une preuve d'achat. Toutefois, les frais de transport et de manutention, ainsi que les paiements versés à un tiers pour l'assemblage ou le démontage du produit, demeurent la responsabilité de l'acheteur. Les acheteurs de produits avec « boîte ouverte », précédemment retournés ou « en liquidation », ainsi que les acheteurs initiaux de produits dont la période de garantie est terminée, peuvent obtenir des pièces de rechange auprès de Sunjoy Group pour des produits actuellement en production, à peu de frais.

Exclusions:

les articles utilisés à des fins commerciales, locatives ou non résidentielles et les articles endommagés par des phénomènes naturels, des actes de vandalisme, un usage inapproprié ou un assemblage inadéquat ne sont pas couverts. La corrosion et la rouille de la quincaillerie ne sont pas couvertes. Une preuve d'achat (une copie de votre reçu daté) doit être présentée avec toute réclamation au titre de la garantie. La garantie n'est accordée qu'à l'acheteur initial et est non transférable. Si l'article original n'est plus offert, il sera remplacé par un article d'une couleur et d'un style similaires. Certains États ou certaines provinces ne permettent pas l'exclusion ou la limitation d'une garantie implicite, de sorte que les limitations et exclusions mentionnées ci-dessus peuvent ne pas s'appliquer à vous. Cette garantie vous confère des droits précis. Il est possible que vous disposiez également d'autres droits, qui varient d'un État ou d'une province à l'autre.