

NOTES:

1. TECHNICAL DATA SUBJECT TO CHANGE WITHOUT NOTICE.
2. PRODUCT DIMENSIONS: U.S. IMPERIAL (inches).
3. DASHED LINE INDICATES INTERMITTENT DUTY.

SOUND LEVEL LESS THAN 60 dB(A)

NORMAL AMBIENT 1°C - 40°C

RELATIVE HUMIDITY 8% - 100% NON-CONDENSING

ENVIRONMENT CLEAN AND DUST FREE

GAST

A UNIT OF **DEX** CORPORATION

BENTON HARBOR, MI U.S.A.
 Ph: 616/926-6171
 Fax: 616/925-8288
 Web Add.: www.gastmfg.com

PART NUMBER:

STD463

REV.

B

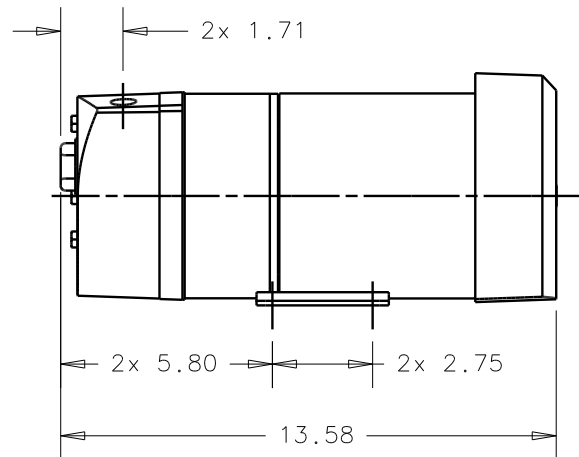
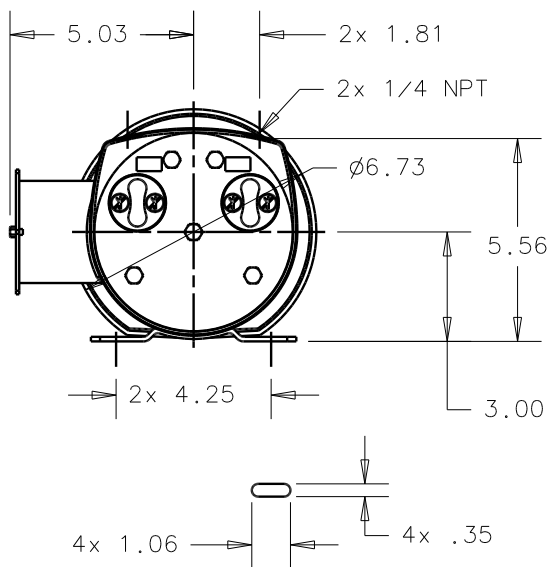
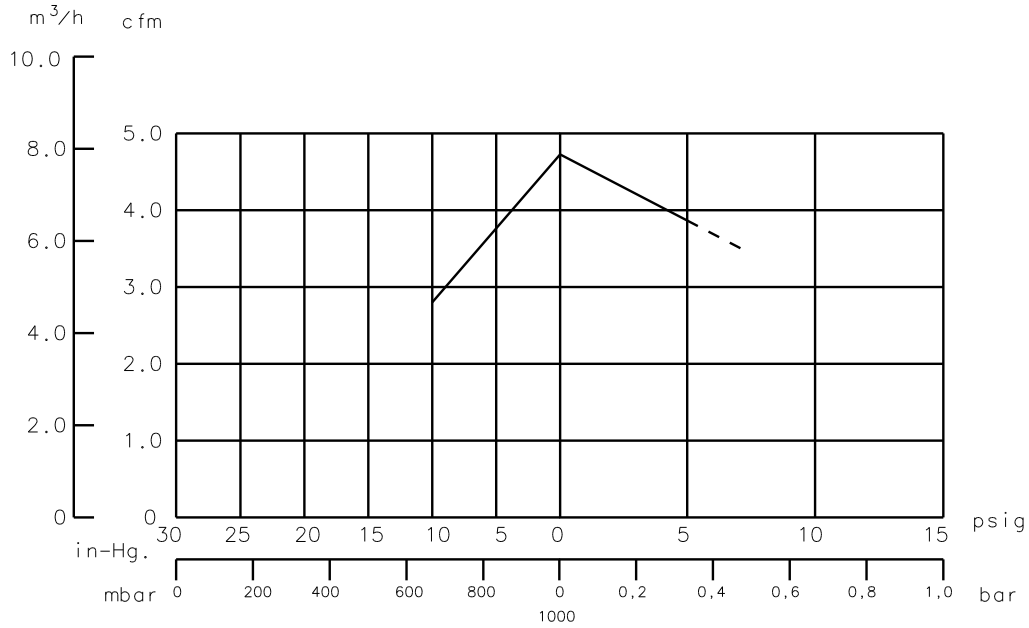

PRODUCT SPECIFICATIONS

MODEL NO.	MOTOR VOLTAGE	RPM		HP	kW	NET WT.	
		60 Hz	50 Hz			lbs.	kg
AT05-101-G215DX	115-1	1725	----	1/4	0.19	31	13.6