

# PRODUCT OVERVIEW

Before using this product, please read the manual carefully and keep it for future reference.

Note: The illustrations of the product, accessories, and user interface in this user manual are for reference purposes only. The actual product and its functions may vary due to product enhancements.

What's included in the box: Air purifier Main Unit, Power Adapter, User Manual.

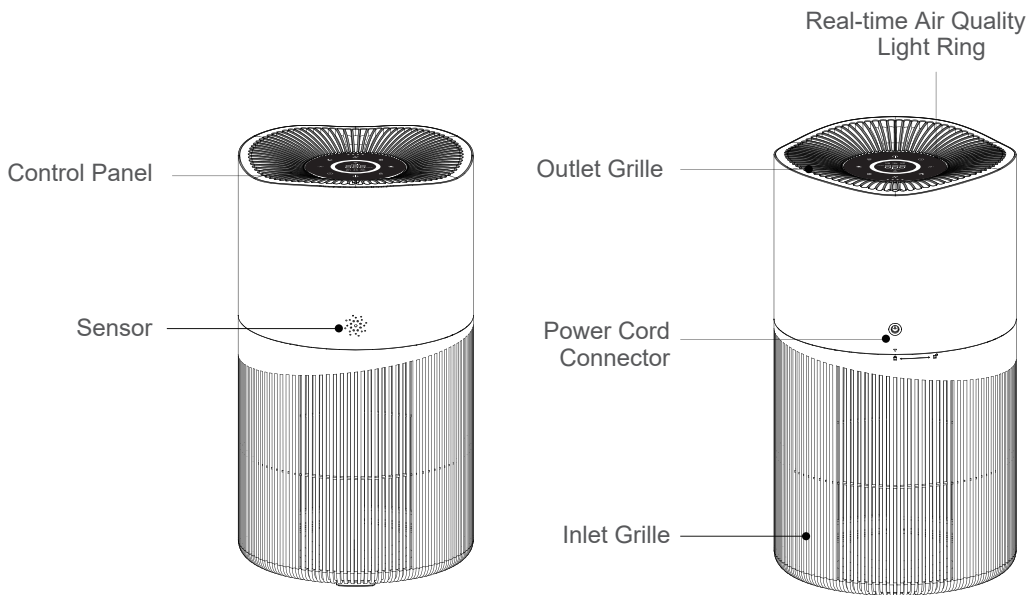

# PRODUCT OVERVIEW

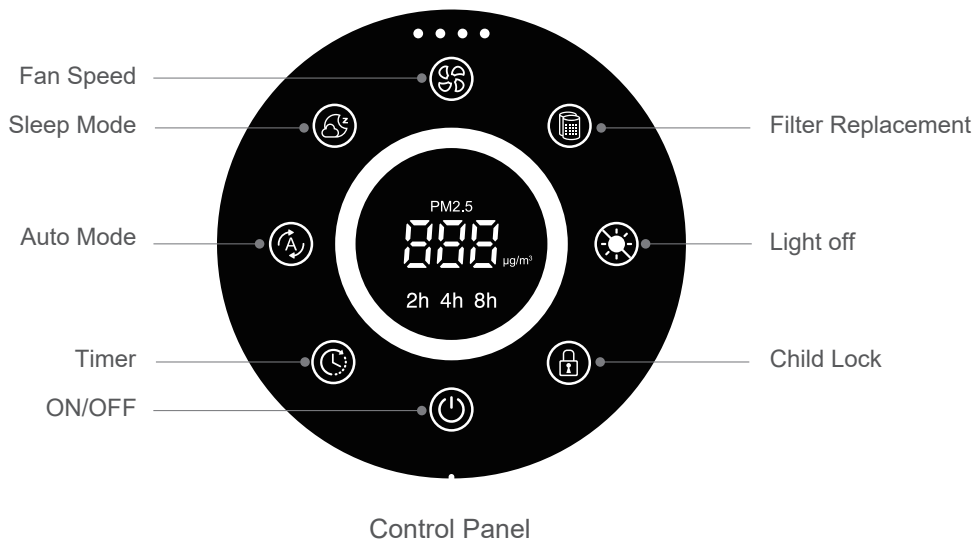

# How to use

## CAUTION

1. Remove the plastic bag from the filter before operating.
2. Power Adapter inside of the filter.

## Connect to an outlet

Connect one end of the power adapter to the power cord connector and plug the other end into an outlet.

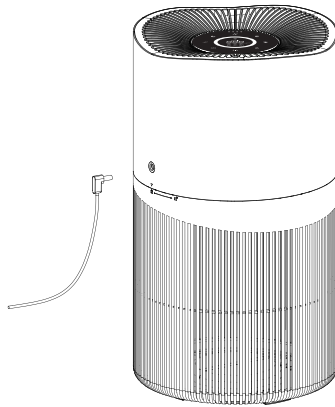

## Tips

For better purification, it is recommended to keep doors and windows closed when using the air purifier.

## Standby Mode

After connecting to an outlet, the air purifier enters the self-test procedure, and then stay in the Standby Mode. The  button will be dim Red, while all of the other lights are off.

## ON/OFF



Press the  button to power on (defaults to Automatic Mode) or to power off.

## Fan Speed

Press the  button to change the fan speed while the air purifier is powered on. The Fan Speed changes one step at a time, cycling through Low, Medium, High to Turbo. Refer to the indicator status as below.

Speed	Low	Medium	High	Turbo
Indicator	•	••	•••	••••

## Sleep Mode

Press the  button to enter the Sleep Mode. The  button will be highlighted in White. After 10 seconds all of the lights will go off. To reactivate the screen, simply touch any button.



## Auto Mode



Touch the  button to enter the Automatic Mode. The air purifier will automatically adjust the Fan Speed according to the real-time air quality index.

## Timer

Timer can be set from 2-4-8 H.

## Child Lock

(1) Child Lock: Long press the  button for 3 seconds, the air purifier will enter Child Lock Mode. The  button will be highlighted in Red.

(2) Long press the  button for 3 seconds, the child lock mode will be unlocked. The  button will be back to dim White.

## Light Off function ✨

The light off function is turned on by default at power on(all light off), touching the ✨ button will turn off the light off function.

## Filter Replacement 🗑️

When the filter service life reaches the set time (approximately 6 months), the icon will highlight in red, reminding the user to replace the filter.

Please refer to the diagram on the right. First, unplug the power adaptor and place the purifier upside down on a table. Then, rotate the air inlet grille counterclockwise and remove it to access the old filter. Replace the old filter with a new one and secure the inlet grille by turning it clockwise until it locks in place according to the positioning mark.

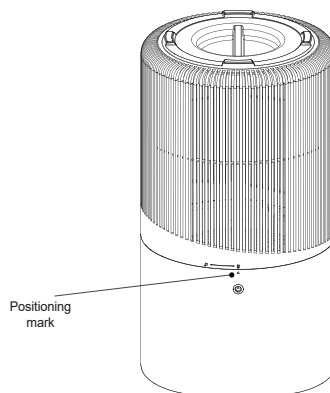

## Reset Filter 🗑️

Long-press the 🗑️ button for 3 seconds. Afterward, all the panel lights on the control panel will flash for 3 times, and the 🗑️ button will highlight in white. At this point, the filter life is be reset.

## Air Quality Indicator

Three-color lights change colors according to the real-time air quality.

Indicator light	Air quality
Green	Good
Yellow	General
Red	Bad

# Basic Parameters

Product Name: Air Purifier

Product Size: Ø250×452mm

Rated Voltage: DC24V

CADR Particles: 402m<sup>3</sup>/h

Product Model: KQJ-0402

Product Net Weight: 3.7kgs

Rated Power: 48W

Noise: ≤60dB(A)

## Warning

- Turn off and unplug the purifier before moving it.
- The purifier cannot turn on when the inlet grille is not installed properly.
- Maintain a distance of at least 10cm between the air inlets and walls or other objects.
- Frequently remove dust, hair, and other particles from the outer mesh screen of the filter, so as to reduce the chance of bacteria growth.
- Remove dust, hair, and particles from the purifier's air inlets to prevent a reduction of air intake.
- Cover the air outlet to prevent dust, hair, and other particles from falling in when the purifier is left unused for a long time.

To avoid fire, electric shocks, or other damage, use the power cord and electrical outlet as instructed below:

- Do not excessively pull, twist or bend the power adaptor, as this may expose or break the adaptor's core.
- The power adaptor must be plugged into a suitable electrical outlet.
- Use the power adaptor that was provided with the purifier, do not use any third party power adaptors.

- Always unplug the purifier before carrying out maintenance to or moving the air purifier.
- When the power adaptor is damaged, it must be replaced with a genuine power adaptor purchased from the manufacturer or after-sales service department.
- Immediately stop using the purifier when it makes unusual sounds, gives off bad odors, overheats, or its fan rotates irregularly.
- Do not stick foreign objects into the protective parts, movable parts, air inlets, or air outlets.
- Keep objects such as hairs or fabrics away from the purifier to avoid blocking the air inlets or air outlets.
- When using in conjunction with gas-fueled appliances (such as gas stoves, gas heaters), please ventilate sufficiently to avoid carbon monoxide poisoning.
- Do not pour liquids, nor throw powders or other small substances into the purifier's air outlet.
- Do not use the purifier in the following circumstances, as they may result in electric shocks, fire, or other damage.
  - Near open flames, such as candles, incense burners, stoves, fireplaces, cigarettes, firecrackers, lighters, multipurpose torches, candle lighters, or fire pans.
  - Near appliances that generate high temperatures, such as electric heaters, fan heaters, electric foot warmers, electric stoves, electric irons.
- Make sure no inflammable objects get into the purifier.
- In unstable locations where the purifier can easily fall over.
- In environments that are extremely hot, humid, or damp, such as bathrooms.
- Children shall not play with the appliance.
- Cleaning and user maintenance shall not be made by children without supervision.

WARNING: RISK OF ELECTRIC SHOCK -These servicing instructions are for use by qualified personnel only. To reduce the risk of electric shock, do not perform any

servicing other than that contained in the operating instruction unless you are qualified to do so.

Note:

If the above methods do not solve the problem, Please contact customer service.

JOYTECH Healthcare Co.,Ltd

No.365, Wuzhou Road Linping District, Hangzhou, China, 311100



**SEJOY®**

**SEJOY®**

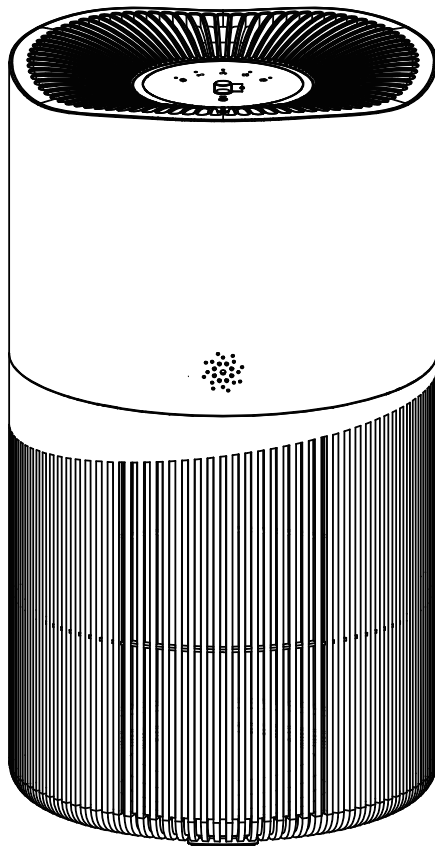

**Air Purifier**  
**USER MANUAL**  
**Model: KQJ-0402**