

O2iTC23/O2i605CM/O2i607CM/O2i562/O2i675/O2i695

Intensifier IP[®] Full HD 1080 Specialty IP Camera



Directions

Be careful not to cause any physical damage by dropping or throwing the camera. Especially keep the device out of reach from children.

Do not disassemble the camera. No after service is assumed when disassembled.

Use only power adapters compatible with the unit.

Be careful to prevent moisture or water penetration into the unit. Particular attention is needed when installing the unit. The screw holes for the installation screws and pipe should be maintained water tight during the whole life time of the product.

All the electrical connection wires running into the unit should be prepared so that water from the outside cannot flow into the unit through the surface of the wires. Penetration of the moisture through the wire for extended period can cause malfunction of the unit or deteriorated image.

Note

This equipment has been tested and found to comply with the limits for a Class A digital device, pursuant to part 15 of the FCC Rules. These limits are designed to provide reasonable protection against harmful interference in a residential installation. This equipment generate, uses and can radiate radio frequency energy and, if not installed and used in accordance with the instructions, may cause harmful interference to radio communications. However, there is no guarantee that interference will not occur in a particular installation. If this equipment does cause harmful interference to radio or television reception, which can be determined by turning the equipment off and on, the user is encouraged to try to correct the interference by one or more of the following measures:

- Reorient or relocate the receiving antenna.
- Increase the separation between the equipment and receiver.
- Connect the equipment into and outlet on a circuit different from that to which the receiver is connected
- Consult the dealer or an experienced radio/TV technician for help.

Caution

Any changes or modifications in construction of this device which are not explicitly approved by the party responsible for compliance could void the user's warranty.

Revision History

Date	Revision	Details
May 4 th , 2016	1.0	First manual revision creation.

Contents

- 1. Introduction 5**
 - 1.1. Overview 5
 - 1.2. Specifications 6

- 2. Product Description 8**
 - 2.1. Contents 8
 - 2.2. Product Preview 8
 - 2.3. Physical description 9
 - 2.3.1. External View 9
 - 2.3.2. Dimensions 9
 - 2.3.3. Front and Rear view of Main Unit 10
 - 2.3.4. Factory Default Switch 10
 - 2.4. Functional Description 11

- 3. On Site Installation 13**

- 4. Getting Started 14**
 - 4.1. PC Requirements 14
 - 4.2. Quick Installation Guide 15
 - 4.2.1. Connect PC and camera to network 15
 - 4.2.2. Set IP parameters 15
 - 4.2.3. Remote video connection 16
 - 4.2.4. Additional settings through connection to the Admin Page 18

- 5. Troubleshooting 19**
 - 5.1. No power is applied 19
 - 5.2. Cannot connect to the Video 20
 - 5.3. Technical Assistance 21

- Appendix A – Important Notice in Exchanging SD Card (Micro SD) 22**

1. Introduction

1.1. Overview

This product is a multi-codec (H.264, MJPEG) IP camera (or network camera) built with embedded software and hardware technology. It enables real time transmission of synchronized video up to 1,080P and audio data. Remote clients can connect to IP Camera for the real time video/audio data through various client solutions running on PC or smart device. Real time 2-way communication is available through bidirectional audio communication feature.

Intensifier IP® technology is the most optimized solution for indoor and outdoor surveillance in low-light conditions by using superior CMOS sensor with low-light sensitivity ISP sensor. Intensifier IP® is especially beneficial in poor lighting environments, efficiently reducing noise and ghosting while maintain a color image without the use of IR LEDs.

Designed to be a stand-alone streaming audio & video transmission device, the camera can be applied to various specialty application areas such as elevators, banks, ceilings, door panels, etc.

The separate main unit and camera design allows for flexibility in installations. The camera portion can be installed to fit the application need, while the encoder box can be hidden from view. Embedded PoE (Power over Ethernet, IEEE 802.3af) will enable the owner to reduce the total cost of ownership by reducing on-site wiring works for the installation.

1.2. Specifications





Camera	
Image sensor	Progressive scan 1/3 inch CMOS 2M pixels
Full resolution	1,920 x 1,080 pixels (Full HD)
Sync System	Internal
Lens	2.9mm fixed (3.6mm for O2i562)
Day & Night	AUTO, DAY, NIGHT
Sensitivity	Intensifier Max – 0.0005 Lux
Back Light Compensation	ON / OFF
White Balance	ATW(2.000K ~ 10,000K) / MANUAL / PUSH
Exposure	DC / ESC
WDR	ON / OFF
3D-DNR	0 ~ 20
Intensifier	AUTO ON (Max 128x) / OFF
Privacy Mask	ON / OFF (10 Programmable Zones)
Motion Detection	ON / OFF (4 Programmable Zones)
Digital Zoom	1x ~ 12x
Mirror	H / V / Rotate
DEFOG	ON / OFF
OSD	BUILT IN
Video	
Compression method	Simultaneous Dual Codec (H.264 / MJPEG)
Resolution	1,920 x 1,080@30fps
Multi-Profile Streaming	- 5 simultaneous video profiles - Select the codec type, resolution and frame rates for each profile.
Intelligent Bit-Rate Control	VBR or CBR
PTZ	Digital PTZ & Video crop
Image Setting	Text overlay, Privacy mask, De-interlace filter
Motion detection	3 regions
Audio	
Mono Upstream	32Kbps G.726 ADPCM, 64Kbps 16bit μ -law PCM ~ MIC/Line-in
Mono Downstream	64Kbps 16bit μ -law PCM ~ Line-out

Network	
Network Protocol	- IPv4, TCP, UDP, IGMP, ICMP, ARP, RARP, PPPoE, RTCP - RTP, RTSP, SDP, HTTP, SMTP, FTP, DHCP, UPnP - NTP, DNS, DynDNS
Dynamic IP	Speco DDNS (free of charge)
Security	- User ID & Password protection, IP address filtering - Digest Authentication, User Access Log
Streaming method	- RTSP streaming with proprietary format for control information - standard RTSP streaming - HTTP streaming
External Terminals	
LAN	10/100BaseT LAN (auto MDIX)
Alarm input / output	Alarm I/O (1 Sensor input & 1 Relay output)
Factory Reset	Supported
Audio	MIC/Line in, Line out
Power	DC 12V input
Alternate Power	
Standard PoE	IEEE802.3af Supported
Alarm & Event	
Intelligent Video	Motion Detection
Alarm Triggers	Motion Detection + Sensor Input
Alarm Events	Video file upload(FTP), Still Image transmission(Email), Relay output
Alarm Buffer (Audio/Video)	Configurable Pre-alarm (5~15 sec) & Post-alarm (10~60 sec)
Miscellaneous	
Operating Temperature	4°F ~ 113°F
Operation Humidity	8 ~ 80% RH
Power	DC 12V, 0.5A
Dimensions(W x H x D)	Camera : check item spec sheet Encoder Box : 45.6mm x 25mm x 114mm
Weight	Camera : Check item spec sheet Encoder Box: 0.3 lb
Approvals	FCC, RoHS
Package information	Unit, CD, mounting screws

2. Product Description

2.1. Contents

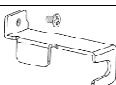
The product package contains the following :

Contents	Description	Remarks
Camera	Main unit and camera unit	
Accessories	Screws (1 type)	
	Anchors (1 type)	
	L-type wrench	
	Cable bracket and Screw	
CD	Software & User's Guide	
Reference Guide	Quick installation guide, Guide pattern	

2.2. Product Preview

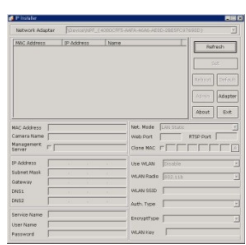
Model	ONSIP Installer
	
Camera Unit & Main Unit	PC software to allocate an IP address to the IP Camera

2.3. Physical description

2.3.1. External View



Figure 2-1. External view of main unit

2.3.2. Dimensions

Unit : mm

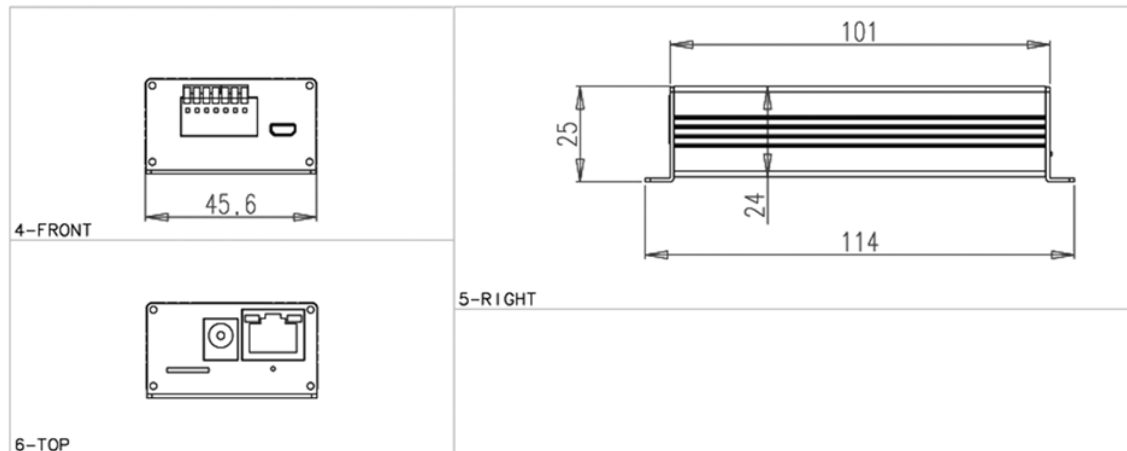

Figure 2-2. Dimensions

2.3.3. Front and Rear view of Main Unit

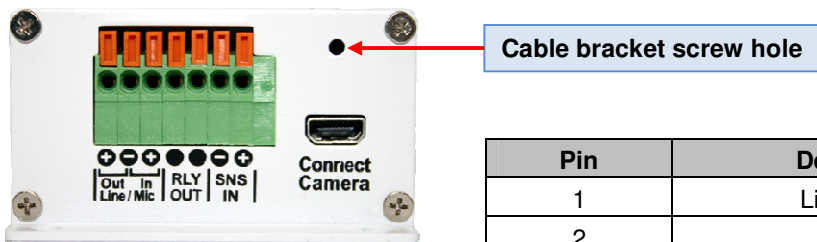

Figure 2-3. Front view

Pin	Description
1	Line Output
2	Ground
3	MIC/Line Input
4	Relay Output
5	Relay Output
6	Sensor Input (-)
7	Sensor Input (+)
Connect Camera	Connect Camera Unit

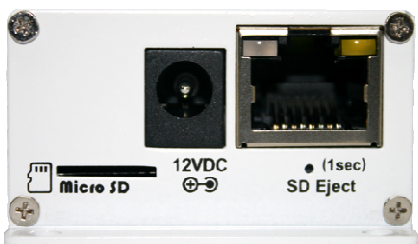

Figure 2-4. Rear view

2.3.4. Factory Default Switch

Factory default switch is provided for returning the IP camera to factory default state.

There are two functions assigned to factory default switch.

1. **Returning to Factory Default State** : Press the switch about 5 seconds while power is applied to return to factory default state.
2. **Safe Removal of Micro-SD Card** : Press the switch for 1 second to unmount Micro-SD Card for safe removal.

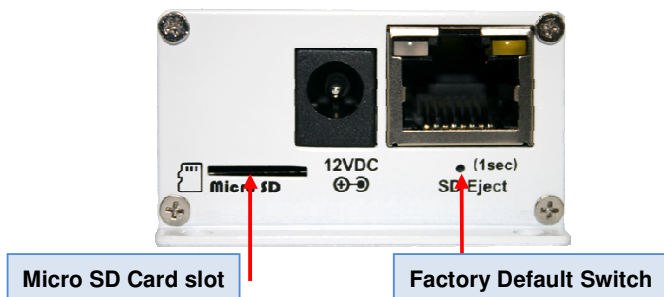

Figure 2-4. Factory Default switch and Micro-SD Card slot

2.4. Functional Description

- **Power** : Power input for supplying 12V DC power.



Caution : If camera is powered by PoE, do not plug in DC Jack with active DC power into DC power connector.

- **Network (LAN)**

100Mbps Ethernet connector (RJ-45) with PoE standard (802.3af). LED on the Ethernet connector shows the status of the camera as follows:

- **Link LED**

It will be lit with orange color when network cabling is all right. Blinking orange color indicates that normal data transmission is under way. Off state indicates that there is trouble in network connection

- **Status LED** (It will be lit in green or red depending on the status)

- ① **Green** : Green color indicates that the camera is in normal operation mode. Continuous green indicates that data transmission is possible. Blinking green means that someone is connected.
- ② **Red** : Continuous or blinking red indicates that hardware is in abnormal condition.



LED will be lit with red momentarily and it will be lit with green after a while when power is applied

- **Micro SD Card slot**

Please insert SD memory card when you want to use SD memory card. In case of pulling out SD memory card, please push the SD card.

- **Connect Camera**

Connect Camera Unit.

- **MIC/Line Input**

Connect external audio source or microphone.

- **Line Output**

Connect speakers with built in amplifier. Audio from remote site is output through Line out in bi-directional audio mode.

• **Sensor Input**

Connect external alarm sensor. Examples of sensing devices are infrared sensor, motion sensor, heat/smoke sensor, magnetic sensor, etc. Connect the two wires of the sensors to "Sensor Input".

The sensor type (NC/NO) can be set in admin page. Multiple sensor devices can be connected in parallel.

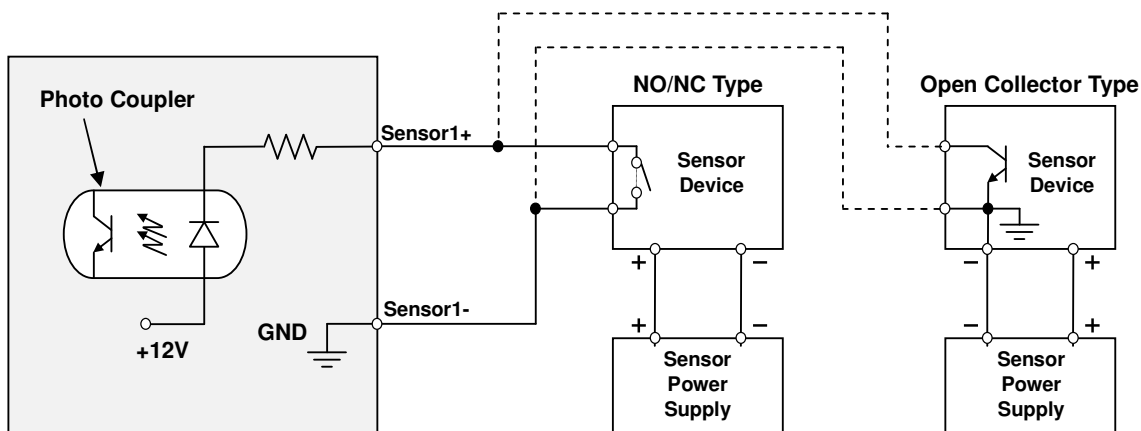
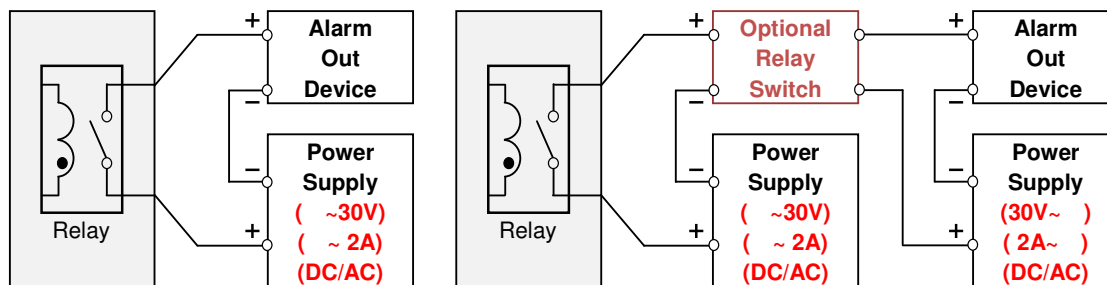

Figure 2-6. SENSOR input and connection of the sensor

• **Relay Output**

Relay output is provided for connecting alarm devices or for remote on/off control of devices such as light. Relay is normal open and it will be closed upon alarm annunciation or remote on. The relay is capable of switching **30V AC/DC, 2A**. For the application which needs power switching beyond this limit, use additional relay switch as shown in the right of Figure.



* Left : switching requirement below 30V, 2A

* Right : switching requirement higher than 30V, 2A. Apply this connection when either voltage or current exceed the limit.

Figure 2-7. RELAY Output connection

3. On Site Installation

Use cables and conduits that are suitable for the installation. Particular attention should be paid in the installation so that no moisture is allowed to penetrate into the unit through the cables or conduits during the life time of the product. Products of which the internal parts are exposed to moisture because of improper installation are not covered by warranty. The main unit must not be exposed to weather elements.

1. Connect the wire from the Camera unit (example shown below) to the Connect Cable terminal of the Main unit.

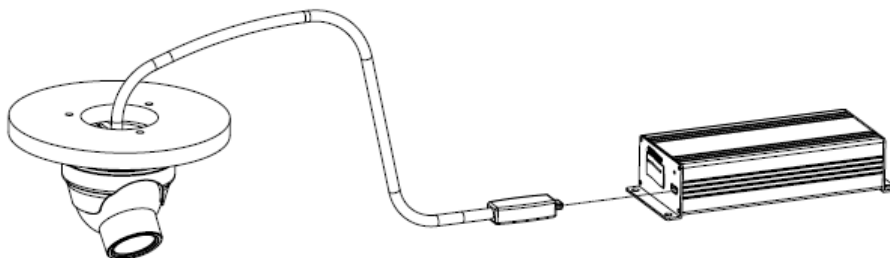

2. Fix the connecting wire from the camera to the main unit by using the cable bracket.

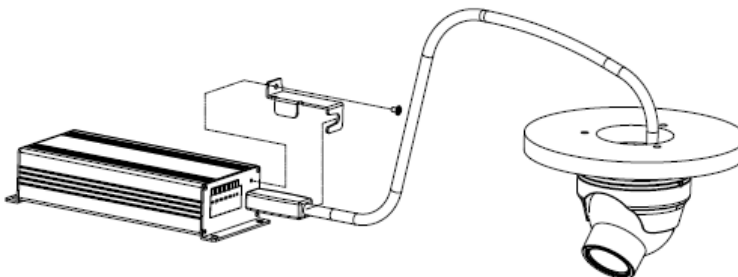

3. Connect the power cable and LAN cable to the main unit. If connecting to a PoE switch, the main unit does not need a separate power supply.

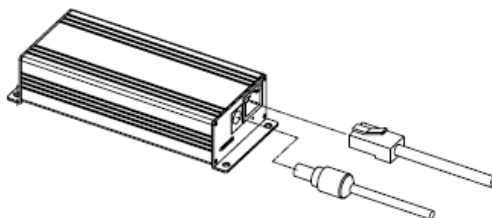

4. Getting Started

4.1. PC Requirements

Audio/Video streaming data received from the camera can be displayed or stored in a PC running client programs. Minimum requirement of the PC is described below:

ITEM	Minimum Requirement	Recommended Specification
CPU	Intel Core i3 3Ghz	Intel Core i7
Main Memory	2GB	4GB
Operating System*	Windows XP	Windows 7 (64bit)
Web Browser	Internet Explorer 8 or higher	Internet Explorer 8 or higher
Graphic Card	Video RAM 256MB Resolution 1920x1080	Video RAM 1GB Higher than 1920x1080
Network	10 Base-T Ethernet	100 Base-T Ethernet

* Operating Systems supported: Windows 2000 Professional, Windows XP / Vista / 7

4.2. Quick Installation Guide

4.2.1. Connect PC and camera to network.

1. Prepare a PC to run programs for the installation and video connection (PC is needed to assign IP address to camera)
2. In the case of using PoE, connect the PC and camera to the network using one of the following ways. If your LAN Switch does not support standard PoE, connect the main unit as shown in dotted line in Figure. The DC power is applied through DC adaptor.

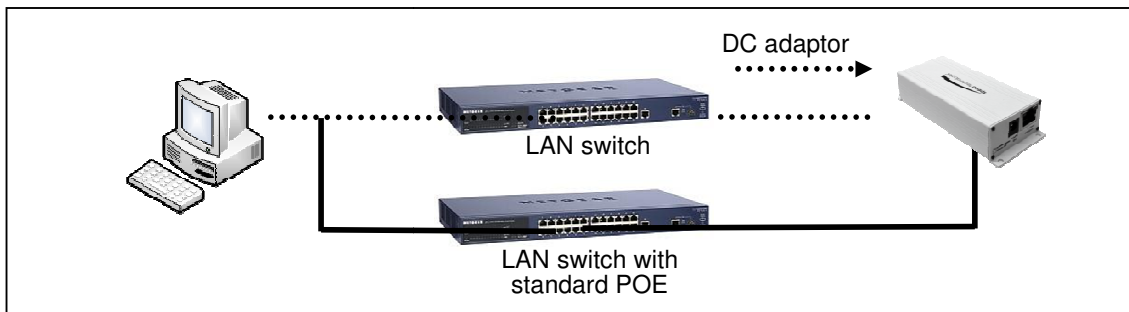
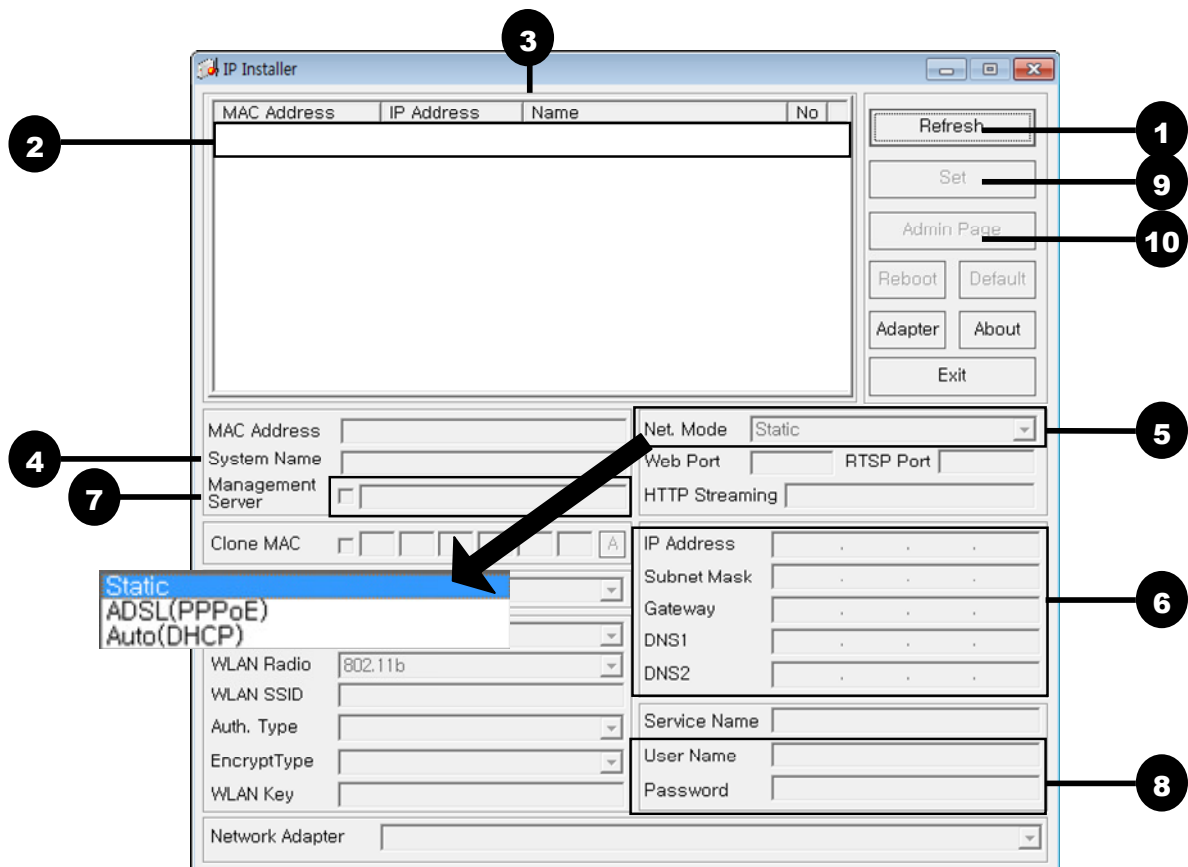

Figure 4-1. Power and network connection

4.2.2. Set IP parameters

Follow the sequence below for setting the IP parameter

- i) Run ONSIP installer
- ii) Click (1) in ONSIP installer window.> Double click on (2) > Fill in (4) > make a selection in (5) > Fill the parameters in (6)
- iii) Click on (9) to apply the settings.
- iv) You can connect to admin page by clicking on (10).



Click on the field in (3) for sorting and rearranging the list.

Select network mode that best suits from the drop down list in (5). You can choose either Static or ADSL and Auto (DHCP), respectively. If ADSL and Auto are selected, the fields in (6) are deactivated.

In case of ADSL, fill the User Name and Password in (8) with the values provided by your ISP.

If DDNS service is needed, Check at the box and fill the empty field with hostname you want in (7).

4.2.3. Remote video connection

1. Connection through Web Viewer

Web Viewer offers simplest way of video connection to the camera. For video connection, enter the IP address of the camera in the URL window of Internet Explorer as:

[e.g.] Port 80

Default port 80 can be omitted

<http://172.16.64.133/>

[e.g.] Port 8080

<http://172.16.64.133:8080/>



Note : Active-X module should be installed on your PC before actual connection. If your PC is not connected to the internet, you cannot download Active-X module. Most convenient way of installing the Active-X module is installing Speco-NVR which is available from the CD or our web site.

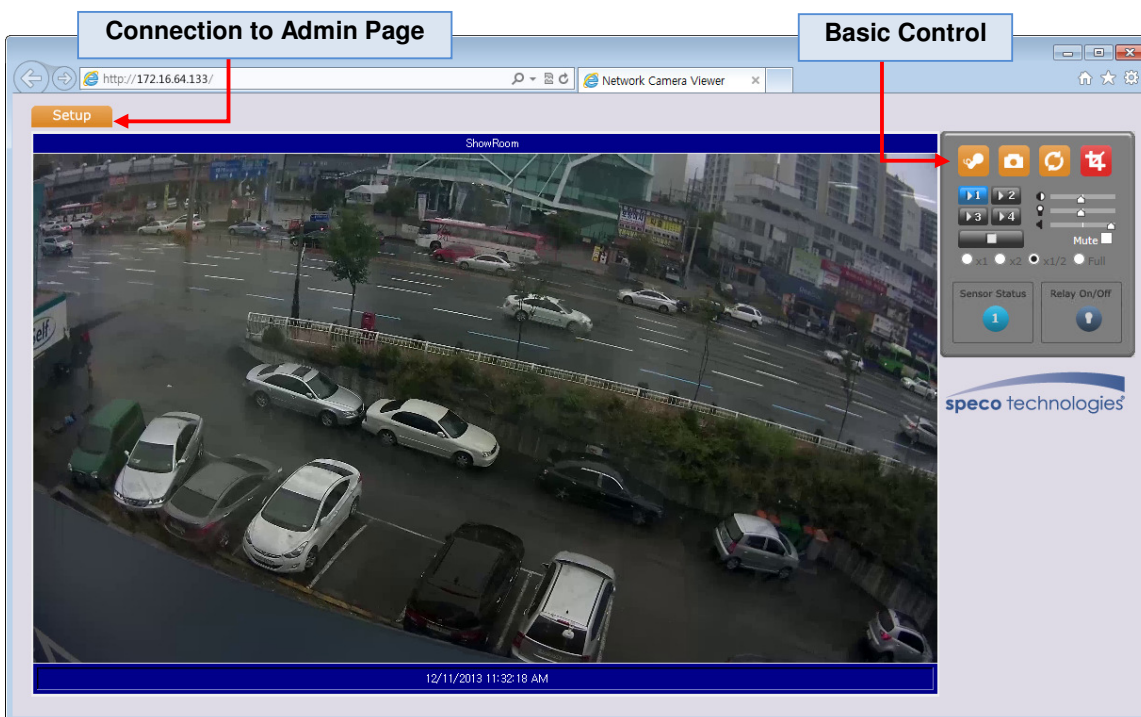

Figure 4-3. Web Viewer

Default ID and password of Admin Page are **“admin”**, **“1234”**.

For more detailed information, please refer to the **“Configuration Guide”**.

4.2.4. Additional settings through connection to the Admin Page

All parameters of the camera are factory default out of the box. For a more sophisticated target application, parameters need to be changed through the admin page. The admin page can be connected through

"http://IP Address:Port Number/admin.htm"

ID and password of the administrator are required. Default ID and password are **"admin"**, **"1234"**.

It is highly recommended to change the ID and password to prevent illegal access to the IP camera.

For more detailed information, **Please refer to the "Configuration Guide"**.

5. Troubleshooting

5.1. No power is applied

- In case of Standard PoE (Power over Ethernet)

Power supply through standard PoE is possible only when the following conditions are met.

 1. Standard PoE is supported on the product.
 2. The LAN switch supports standard PoE.

Make sure that both the IP camera and the LAN switch support standard PoE (IEEE 802.3af)
- In case of DC adapter

If PoE is not applied, the power and network connection should be made through separate cables. It is recommended to use DC adapter supplied by provider for the feeding of the power. In case of replacing the DC power supply, make sure that the power supply meets with the power requirement of the IP camera to prevent damage or malfunction.

5.2. Cannot connect to the Video

Check the status of the network connection through PING test.

Try the following on your PC :

- Start > Run > Cmd > Ping IP address (Ex : Ping 172.16.42.51)
- If "Reply from ~" message is returned (① in the figure below), the network connection is in normal state. Try connection to the video again. If the problem persists, or refer to other trouble shooting notes.
- If "Request timed out" message is returned. (② in the figure below), the network connection or network setting is not in normal state. Check the network cable and settings.

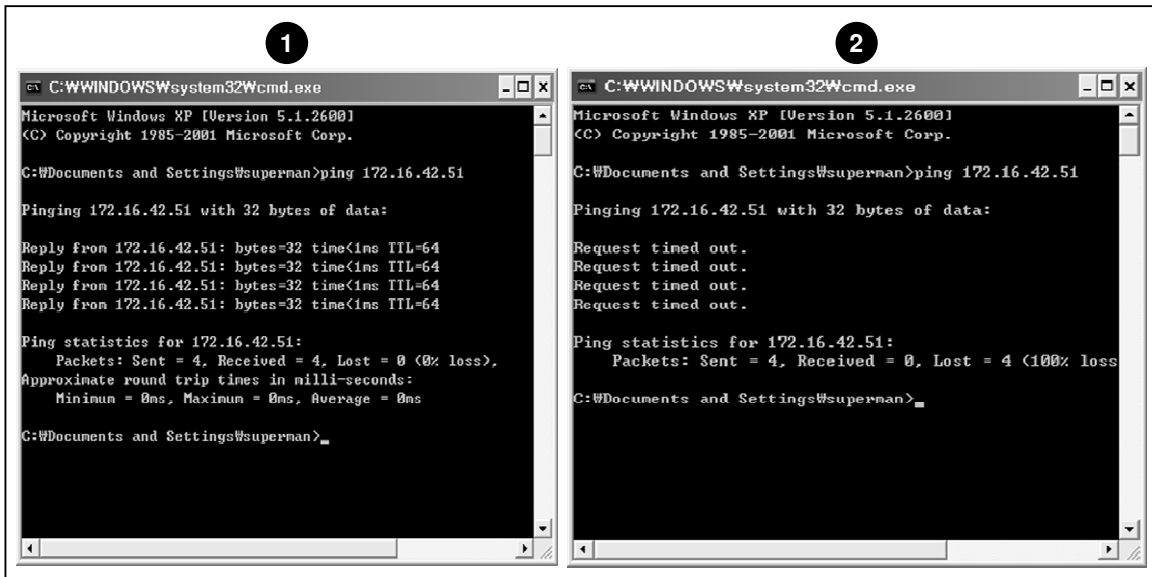

5.3. Technical Assistance

If you need any technical assistance, please contact technical support. For immediate service please provide the following information.



- 1. Model name**
- 2. MAC address and Registration number**
- 3. Purchase date**
- 4. Description of the problem**
- 5. Error message**

Appendix A – Important Notice in Exchanging SD Card (Micro SD)

SD Card is a non-volatile memory device for storing video and audio data on the product. Note that continuous recording to the SD Card will cause the memory cell to wear out, eventually resulting in failure.

When you plug out the SD Card for replacement or other purpose, follow the steps below in order to prevent data loss or crash of the SD Card.

1. Press factory default button for 1 sec to unmount the SD Card .
 - SD Card can also be unmounted by going to **Admin Page -> Sensor&Capture Setup** and **clicking on CONFIRM button at the right of SD Card Unmount menu.**
2. Unplug the SD Card .
 - If no action is taken within 1 minute, SD Card will be mounted again.
3. Plug in new SD Card
4. If the SD Card is a new one for the IP camera, format the SD Card by following through the steps below.
 - Go to Admin Page -> Sensor & Capture Setup
 - In the SD Card management menu, click on **CONFIRM** button at the right of SD Card Format.

For more detailed information regarding connection to admin page, please refer to the “Configuration Guide**”.**