

- en** **Aim:** Getting started with Zelio Soft 2 for beginners. The goal of this document is to help a beginner in the automation field, to get familiarized with Zelio Soft 2. Thus, you will be guided all along the Quick Start in order to create your first program. The list of material to use is given below. Nevertheless, the simulation could be used in case of a lack of material.
- fr** **Objectif:** Commencer avec Zelio Soft 2 pour les débutants. Le but de ce document est de permettre à un débutant en automatisme de se familiariser avec Zelio Soft 2. Ainsi, vous serez guidé tout au long de la présentation rapide afin de créer votre premier programme. La liste du matériel à utiliser est fournie ci-dessous. Toutefois, il sera toujours possible d'utiliser le mode simulation si l'ensemble du matériel n'est pas disponible.
- de** **Zweck:** Einführung in die Arbeit mit Zelio Soft 2. Dieses Dokument soll Einsteigern im Bereich der Automatisierungstechnik die Verwendung von Zelio Soft 2 erläutern. Der Anwender wird Schritt für Schritt durch das Verfahren zur Erstellung seines ersten Programms geführt. Die hierzu benötigte Hardware ist nachfolgend aufgeführt. Für den Fall, dass ein Teil der Hardware nicht verfügbar ist, kann der Simulationsmodus verwendet werden.
- es** **Objetivo:** Introducción a Zelio Soft 2 para nuevos usuarios. El propósito del presente documento es ayudar a los nuevos usuarios en el campo de la automatización, para que se familiaricen con Zelio Soft 2. Por lo tanto, se le guiará a lo largo de todo el proceso de inicio rápido para la creación de su primer programa. A continuación se detalla la lista de materiales que deben emplearse. De todas maneras, es posible utilizar la simulación en el caso de que faltara material.
- it** **Scopo:** Operazioni preliminari con Zelio Soft 2 per utenti non esperti. L'obiettivo di questo documento è quello di aiutare gli utenti non esperti in materia di automazione a utilizzare Zelio Soft 2. Nella Guida rapida vengono fornite le istruzioni per la creazione del primo programma. Di seguito è riportato l'elenco del materiale da utilizzare. Tuttavia, in caso di mancata disponibilità del materiale, è possibile utilizzare la simulazione.
- pt** **Objetivo:** introdução ao Zelio Soft 2 para iniciantes. A finalidade deste documento é ajudar os iniciantes no campo da automação a ficarem familiarizados com o Zelio Soft 2. Assim, o usuário é orientado ao longo de toda a Iniciação Rápida a criar seu primeiro programa. A lista de materiais a serem utilizados é indicada abaixo. No entanto, a simulação pode ser utilizada em caso de falta de material.

- en** Electrical equipment should be installed, operated, serviced, and maintained only by qualified personnel. No responsibility is assumed by Schneider Electric for any consequences arising out of the use of this material.
- fr** Les équipements électriques doivent être installés, exploités et entretenus par un personnel qualifié. Schneider Electric n'assume aucune responsabilité des conséquences éventuelles découlant de l'utilisation de cette documentation.
- de** Elektrische Geräte dürfen nur von Fachpersonal installiert, betrieben, erwartet und instand gesetzt werden. Schneider Electric haftet nicht für Schäden, die aufgrund der Verwendung dieses Materials entstehen.
- es** Sólo el personal de servicio cualificado podrá instalar, utilizar, reparar y mantener el equipo eléctrico. Schneider Electric no asume las responsabilidades que pudieran surgir como consecuencia de la utilización de este material.
- it** Le apparecchiature elettriche devono essere installate, usate e riparate solo da personale qualificato. Schneider Electric non assume nessuna responsabilità per qualunque conseguenza derivante dall'uso di questo materiale.
- pt** A instalação, utilização e manutenção do equipamento eléctrico devem ser efectuadas exclusivamente por pessoal qualificado. A Schneider Electric não assume qualquer responsabilidade pelas consequências resultantes da utilização deste material.

© 2017 Schneider Electric. "All Rights Reserved."

A Required hardware / Matériel nécessaire / Erforderliche Hardware Material requerido / Hardware richiesto / Hardware necessário

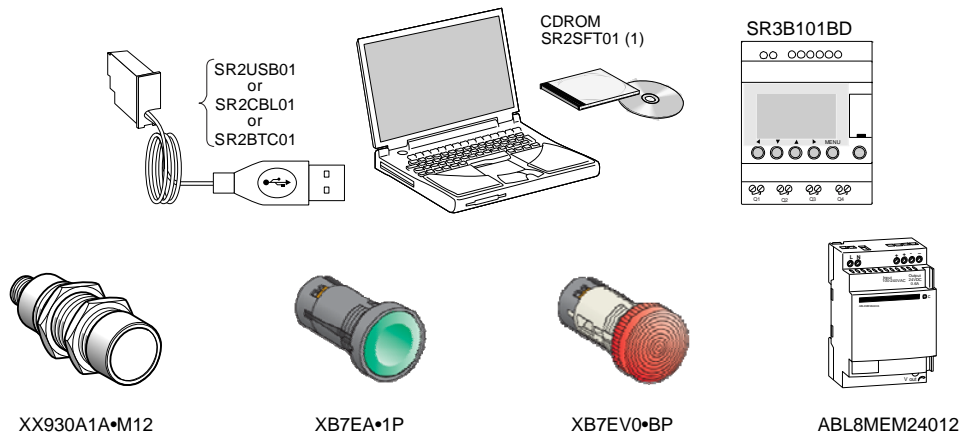

- (1) Also available on the <http://www.schneider-electric.com> website.
 (1) Egalement disponible sur le site web <http://www.schneider-electric.com>.
 (1) Auch verfügbar auf der Website <http://www.schneider-electric.com>.
 (1) También disponible en el sitio web <http://www.schneider-electric.com>.
 (1) Disponibile anche sul sito Web <http://www.schneider-electric.com>.
 (1) Também disponível no site <http://www.schneider-electric.com>.

**B Hardware cabling / Câblage du matériel / Verkabelung der Hardware
Cableado del material / Cavi di collegamento / Cablagem do hardware**

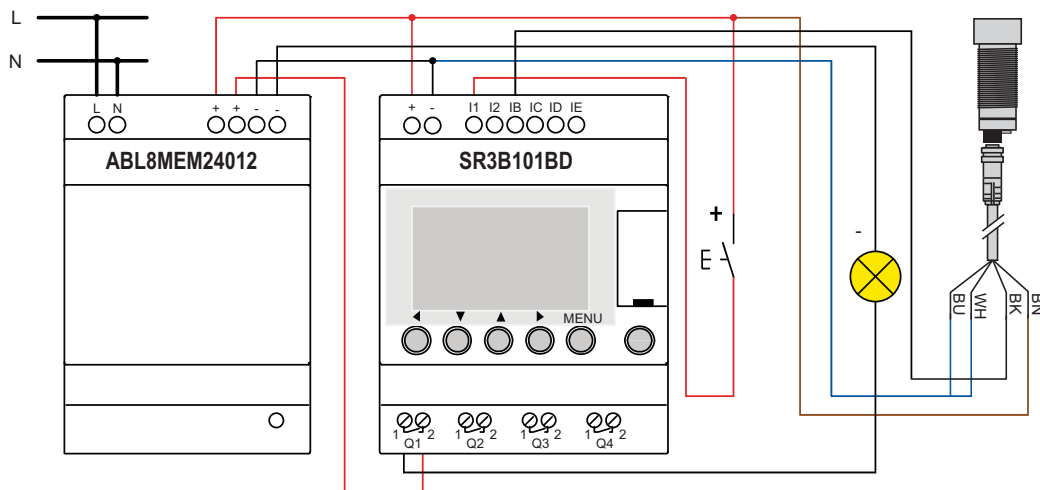

Hardware cabling for programming and transfer / Câblage du matériel pour la programmation et le transfert
Verkabelung der Hardware für die Programmierung und die Übertragung / Cableado del material para la programación y la transferencia
Cavi di collegamento per la programmazione e il trasferimento / Cablagem do hardware para a programação e a transferência

1

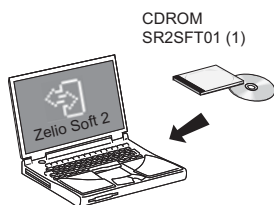

- (1) Also available on the <http://www.schneider-electric.com> website.
- (1) Egalement disponible sur le site web <http://www.schneider-electric.com>.
- (1) Auch verfügbar auf der Website <http://www.schneider-electric.com>.
- (1) También disponible en el sitio web <http://www.schneider-electric.com>.
- (1) Disponibile anche sul sito Web <http://www.schneider-electric.com>.
- (1) Também disponível no site <http://www.schneider-electric.com>.

2

Install the USB cable driver following the instructions in the document http://www.schneider-electric.com/en/download/document/1606428_01A55/
 Installer le pilote du câble USB conformément aux instructions du présent document http://www.schneider-electric.com/en/download/document/1606428_01A55/
 Installieren Sie den Treiber für das USB-Kabel gemäß den Anweisungen im Dokument http://www.schneider-electric.com/en/download/document/1606428_01A55/
 Instale el controlador de cable USB siguiendo las instrucciones del documento http://www.schneider-electric.com/en/download/document/1606428_01A55/
 Installare il driver del cavo USB seguendo le istruzioni nel documento http://www.schneider-electric.com/en/download/document/1606428_01A55/
 Instale o driver do cabo USB seguindo as instruções do documento http://www.schneider-electric.com/en/download/document/1606428_01A55/

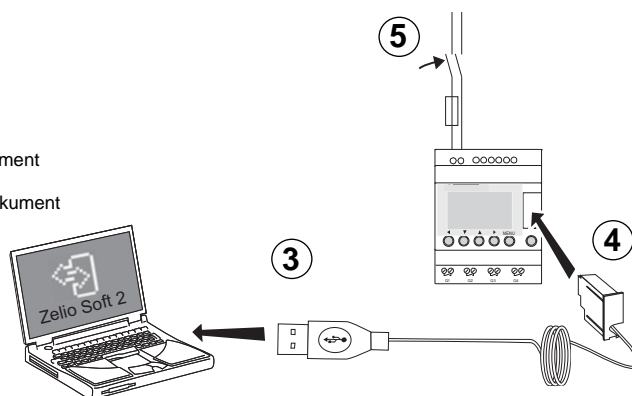

**C Software installation and use / Installation et utilisation du logiciel / Installation und Benutzung der Software
Instalación y utilización del software / Installazione e uso del software / Instalação e utilização do software**

1



2

Follow the instructions / Suivre les instructions / Folgen Sie den Anweisungen
 Siga las instrucciones / Seguire le istruzioni / Siga as instruções

3

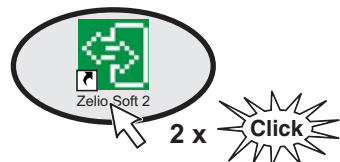

D Programming / Programmation / Programmierung / Programaci3n / Programmazione / Programac3o

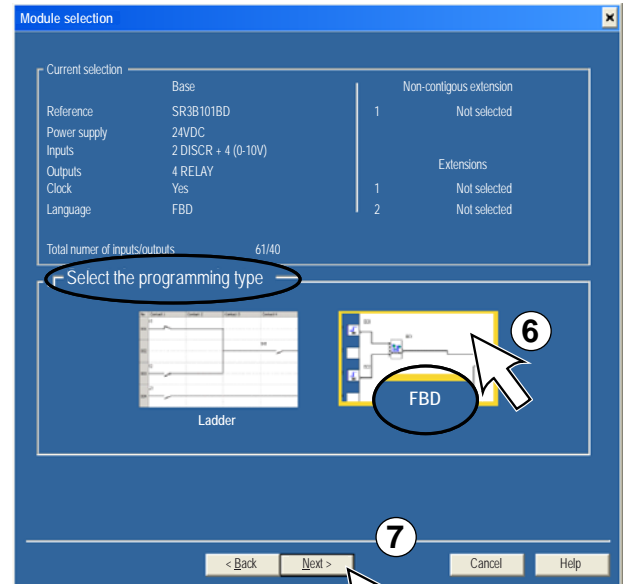
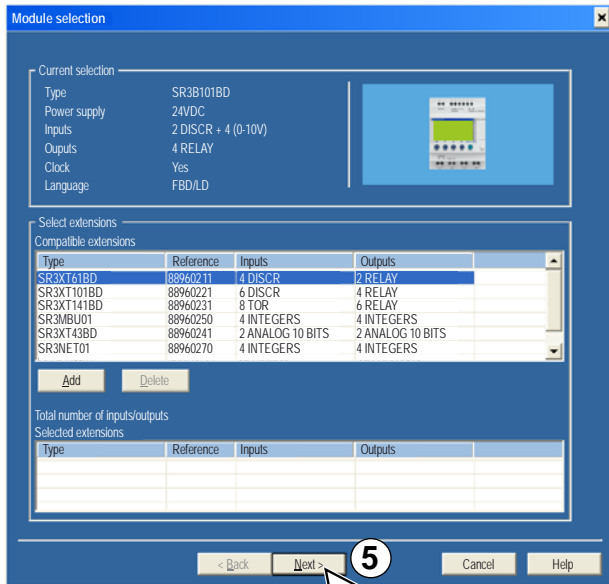
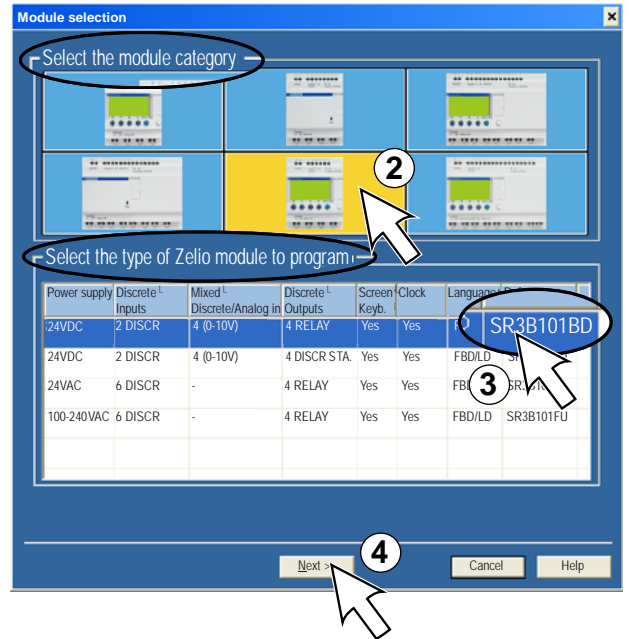
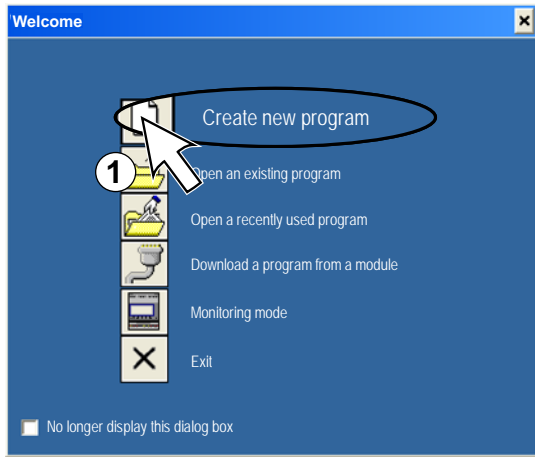

E Online Help / Aide en ligne / Online Hilfe
Ayuda en línea / Guida in linea / Ajuda Online

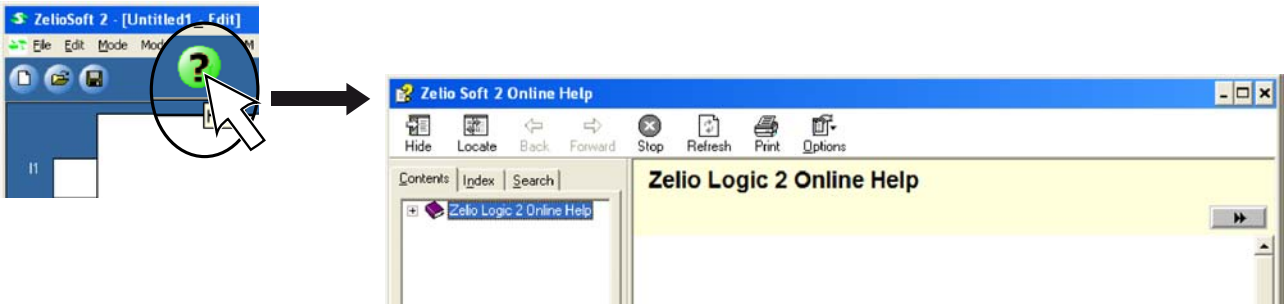

F Two application use cases / Deux modes d'utilisation de l'application / Zwei Verfahrensweisen
Dos casos de uso de la aplicación / Due casi d'uso dell'applicazione / Dois casos de uso do aplicativo

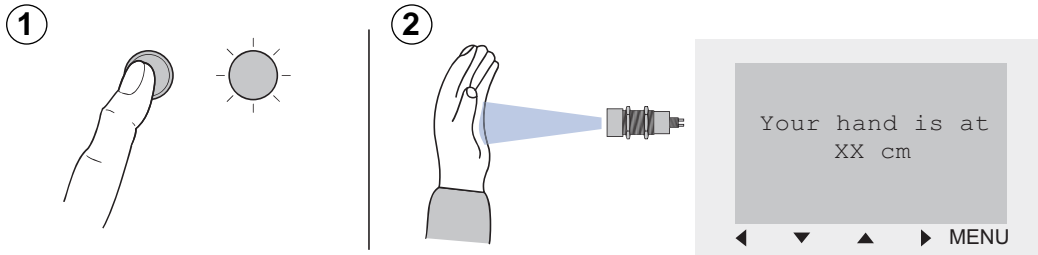

G Use case 1 programming / Programmation du mode d'utilisation n°1 / Programmierungsmethode 1
Caso de uso 1: programación / Programmazione caso d'uso 1 / Programação do caso de uso 1

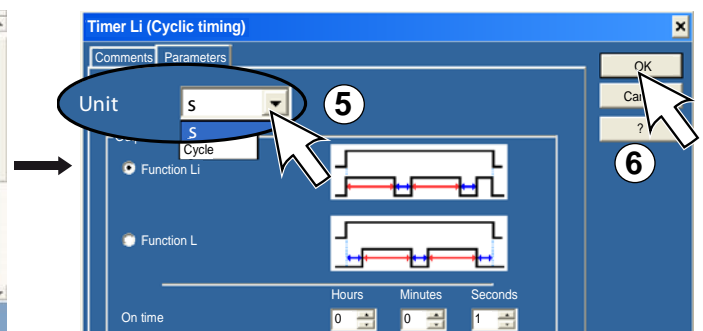
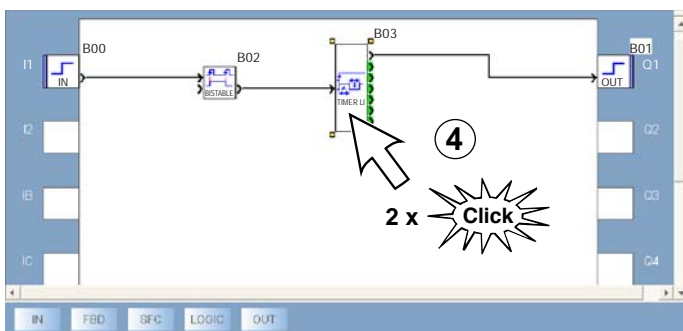
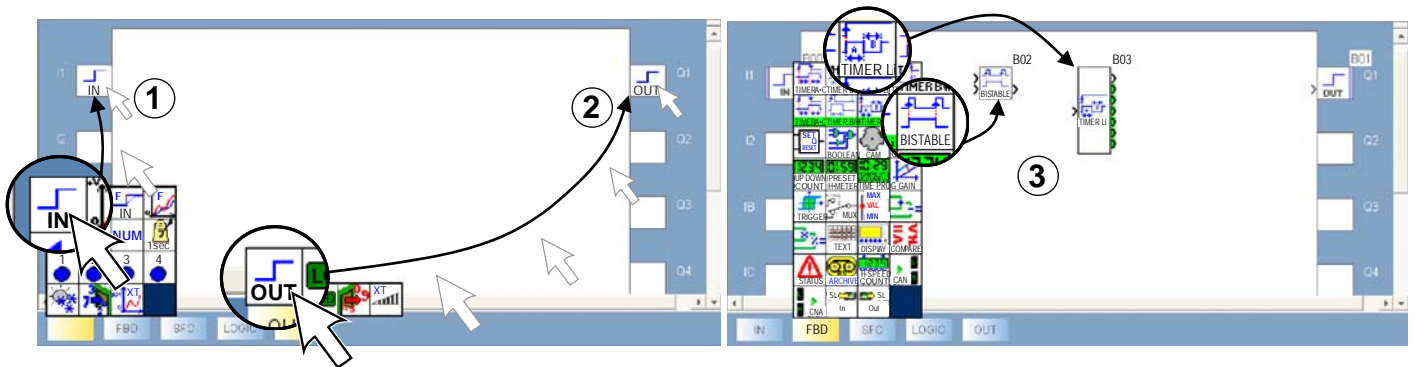
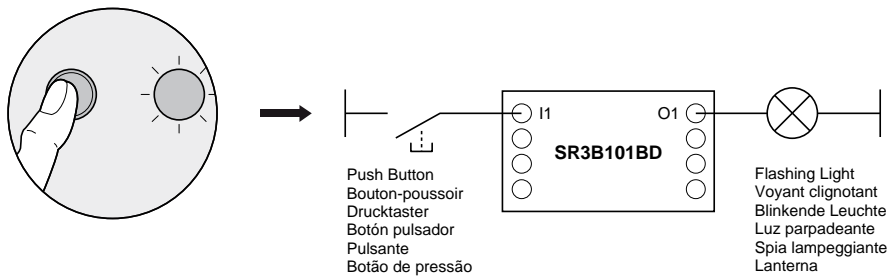

**H Use case 2 programming / Programmation du mode d'utilisation n°2 / Programmierungsmethode 2
Caso de uso 2: programación / Programmazione caso d'uso 2 / Programação do caso de uso 2**

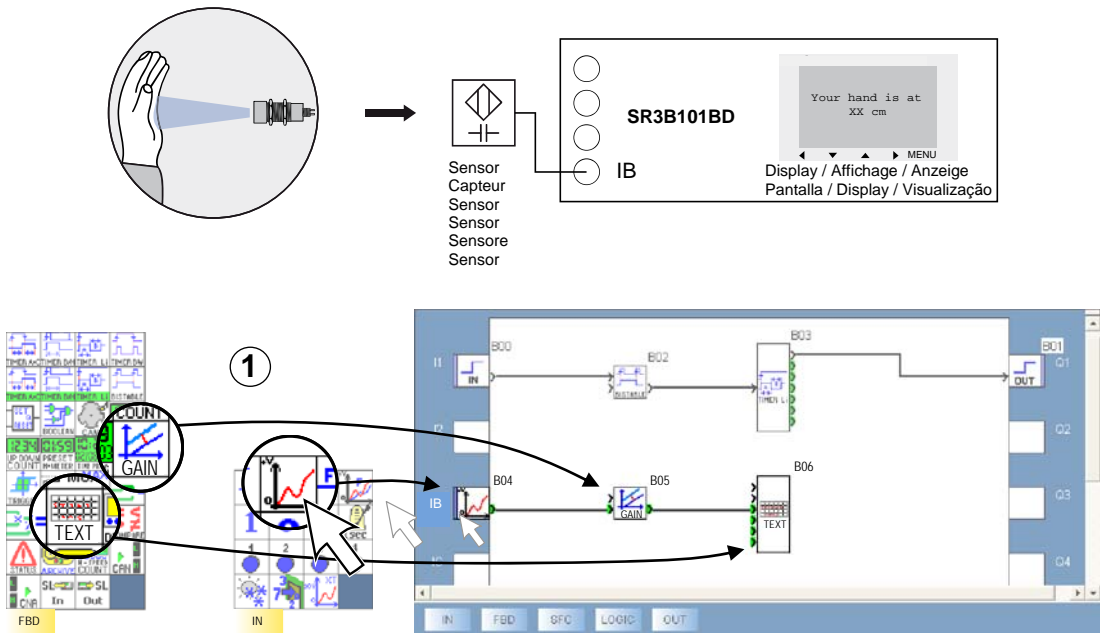

①

②

2 x Click

③

GAIN (Gain = AX x value + C)

Gain numerator (A) (-32768... 32767)

Gain denominator (B) (-32767... 32768) and (not null)

Offset (C) (-32768... 32767)

Range

Upper limit = (-32768... 32767)

Lower limit = (-32768... 32767)

Locking

OK Cancel

- * The gain value depends of the type of sensor used
- * La valeur du gain depend du type de capteur utilisé
- * Der Verstärkungswert hängt von dem benutzten Sensortyp ab
- * El valor de ganancia dependerá del tipo de sensor que se utilice
- * Il valore del guadagno dipende dal tipo di sensore utilizzato
- * O valor de ganho depende do tipo de sensor utilizado

④

2 x Click

⑤

⑥

FBD TEXT (Text)

Current text: B06

No	Function block	Comment
01	Date	
02	Hour	
03	Calendar	

04 B05 Calculation output **

Your hand is at ****#4**** cm

OK Cancel ?

- ** Indicates the distance at which your hand is
- ** Indique la distance à laquelle votre main est
- ** Zeigt die Distanz zu Ihrer Hand an
- ** Indica la distancia a la que se encuentra su mano
- ** Indica la distanza della mano
- ** Indica a distância a que está a sua mão

I Check the program / Vérifier le programme / Program übersetzen
 Compruebe el programa / Selezionare il programma / Verifique o programa

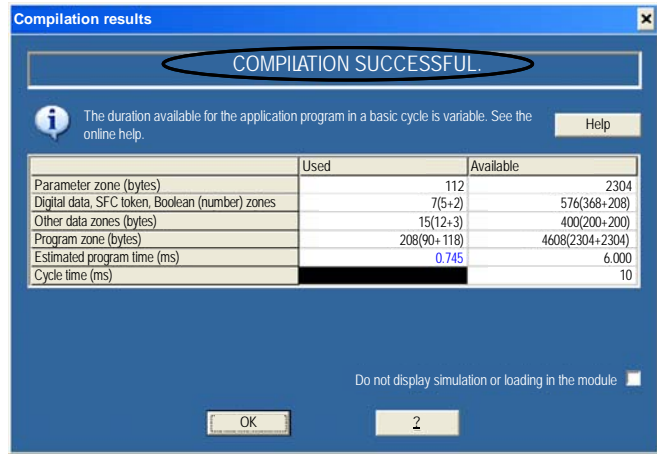
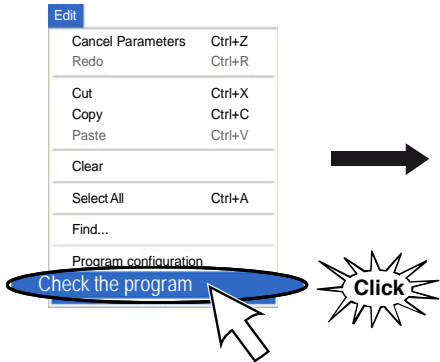

J Simulation / Simulation / Simulation
 Simulación / Simulazione / Simulação



- Runs program / Exécute le programme / Führt das Programm aus / Ejecuta el programa / Esegue il programma / Executa o programa
- Stops program / Arrête le programme / Hält das Programm an / Detiene el programa / Arresta il programma / Interrompe o programa
- Pause/Run / Pause/Run / Pause/Weiter / Pausa/Run / Pausa/Run / Pausar/Executar
- Simulation of a power outage / Simulation d'une coupure secteur / Simulation eines Stromausfalls
 Simulación de un corte de alimentación / Simulazione di un'interruzione dell'alimentazione / Simulação de um corte de energia

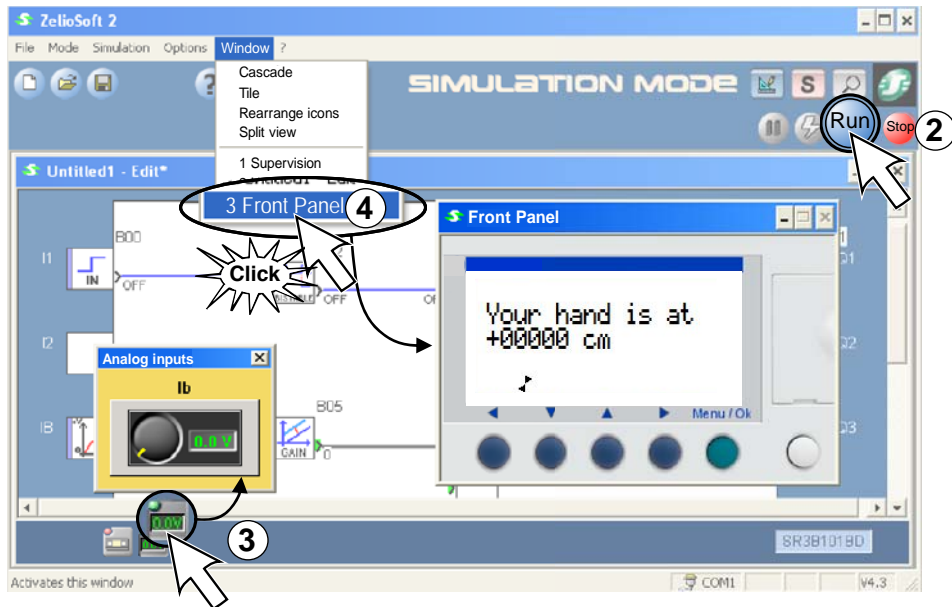

- 5** Click → Stops Program / Arrête le programme / Das Programm wird angehalten
 Detiene el programa / Arresta il programma / Interrompe o programa

K Verify Communication Configuration / Vérification de la configuration de communication / Kommunikationskonfiguration prüfen
 Verificar la configuración de la comunicación / Verificare la configurazione di comunicazione / Verifique a configuração de comunicação

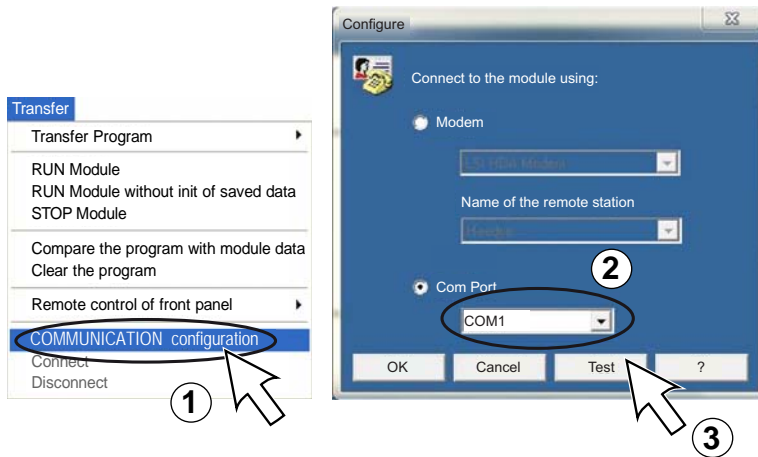

L Transfer: Transfer Program, PC > smart relay / Transfert: Transférer Programme, PC > Module logique / Übertragung: Programm übertragen, PC > Smart Relais
 Transferencia: Transferir Programa, PC > módulo lógico / Transferisci: Transferisci programma, PC > smart relay
 Transferência: Transferir Programa, PC > módulo lógico

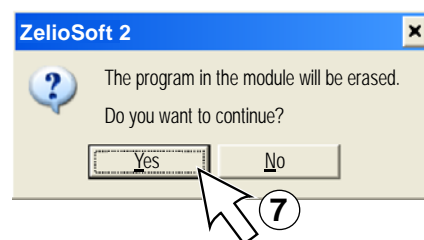
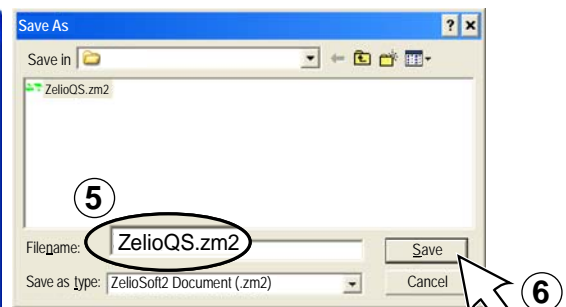
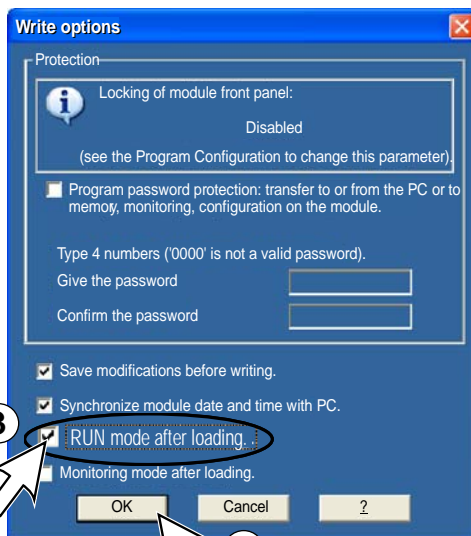
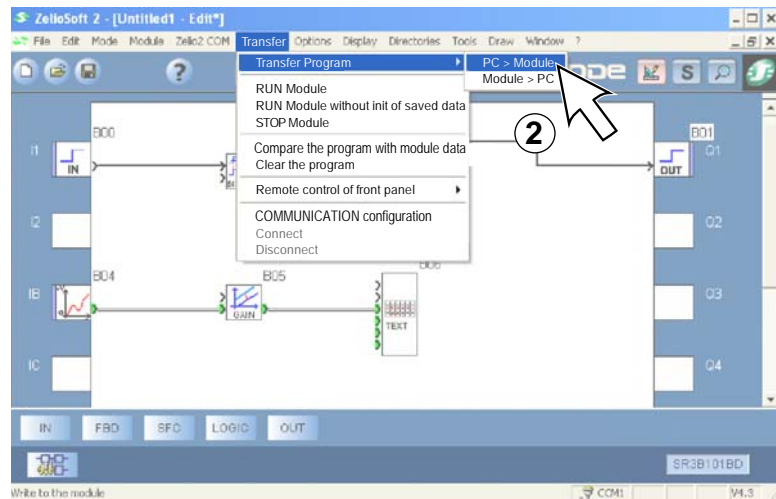

TIPS & TRICKS / TRUCS & ASTUCES / TIPPS & TRICKS / TRUCOS Y CONSEJOS / CONSIGLIO / TRUQUES E DICAS

What you can do with Zelio Soft 2 / Ce que vous pouvez faire avec Zelio Soft 2 / Was Sie mit Zelio Soft 2 machen können
 Aplicaciones de Zelio Soft 2 / Operazioni possibile con Zelio Soft 2 / O que pode fazer com o Zelio Soft 2

- Macros / Macros / Makros / Macros / Macro / Macros

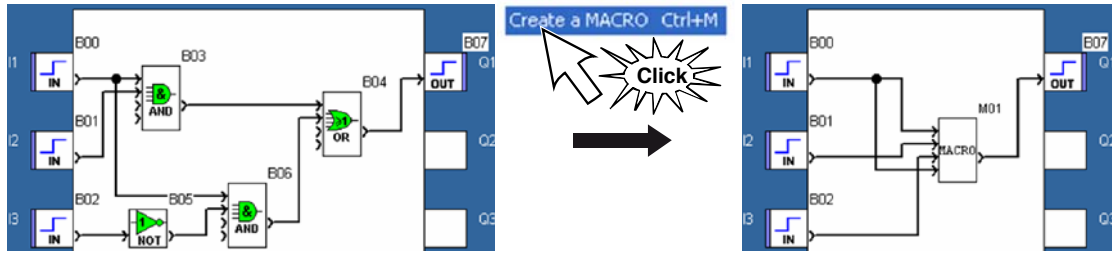

- Customize your program by importing your own pictures / Personnalisez votre programme en important vos propres images
 Anpassung des Programms durch Einbinden eigener Bilder / Personalice el programa mediante la importación de sus propias imágenes
 Personalizzare il programma mediante l'importazione di immagini personali / Personalize seu programa importando suas próprias imagens

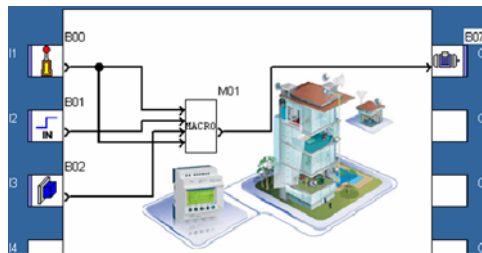

- Split screen function / Fonction de fractionnement de la feuille de câblage / Darstellung mittels geteiltem Bildschirm
 Función de pantalla dividida / Funzione schermata suddivisa / Funcionalidade de ecrã dividido

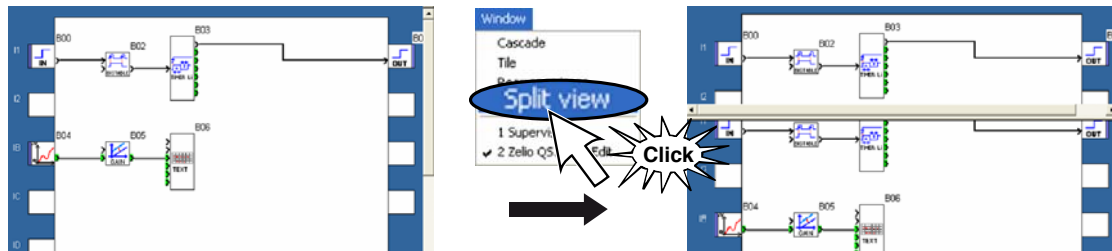

- SFC instructions for cyclic behavior / Instructions SFC pour des comportements cycliques / SFC-Anweisungen für zyklisches Verhalten
 Instrucciones de SFC para comportamiento ciclico / Istruzioni SFC per comportamento ciclico / Instruções de SFC para comportamento ciclico

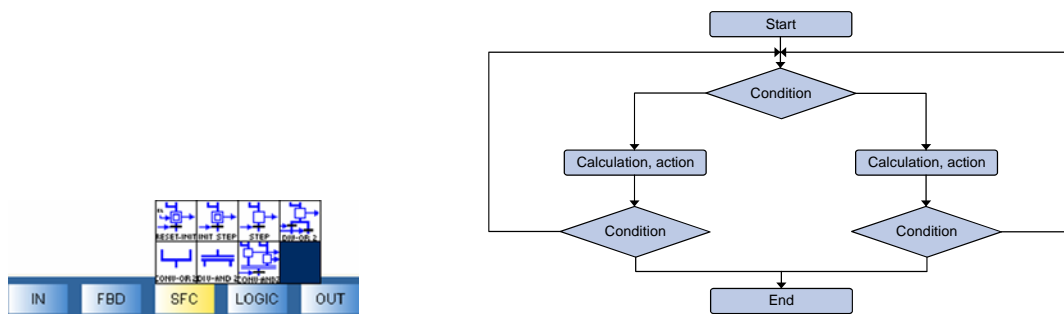

MORE INFORMATION / PLUS D'INFORMATION / WEITERE INFORMATIONEN / MÁS INFORMACIÓN / ULTERIORI INFORMAZIONI / MAIS INFORMAÇÕES

- [Zelio Logic SR2A/SR2B Instruction Sheet](#)
- [Zelio Logic SR2D/SR2E Instruction Sheet](#)
- [Zelio Logic SR3B Instruction Sheet](#)
- [Zelio Logic 2 Smart Relay User Manual](#)
- [Zelio Logic Programming Guide \(ENG\)](#)
- [Zelio Logic Programming Guide \(FRE\)](#)
- [Zelio Logic Programming Guide \(GER\)](#)
- [Zelio Logic Programming Guide \(SPA\)](#)
- [Zelio Logic Programming Guide \(ITA\)](#)
- [Zelio Logic Programming Guide \(POR\)](#)
- [SR2COM01 Quick Start Guide](#)