

KT-ALED210-L1-X-NM-8XX-VDIM

LED AREA LIGHT FIXTURES

DESCRIPTION

Compact 210W High-Performance LED Area Light |
120–277V Input | Bronze Housing |
Multiple Mounting, Optics, and Control options

APPLICATION

Pole-mount or structure-mount outdoor illumination needs (including parking lots, auto dealerships, pathways, roadways, recreational venues, and other general area lighting requirements)



RoHS
Compliant



5 YEAR
WARRANTY



PRODUCT FEATURES

- Compact, low-profile design delivers high-performance illumination and improves application site aesthetics
- Heavy-duty, die-cast aluminum housing with ample heat sinking for enhanced thermal performance
- True U0 design for dark sky friendly performance eliminates undesirable sky glow
- Integrated NEMA/ANSI C136.10 3-pin twist-lock receptacle with shorting cap, standard on all fixtures, simplifies ordering requirements for photo control needs
- Precision-crafted optics, available with type II, III, IV, and V patterns, to meet diverse requirements from general purpose to specification-grade applications
- Integral latch design for hassle-free, hinged access to driver compartment
- Four contractor-friendly mounting options available (sold separately): slip fitter mount, adjustable pole mount for square and round poles, fixed pole mount for square and round poles, and trunnion mount
- Bi-level occupancy sensors and twist-lock photocell accessories available
- Reversible glare shield available, suitable for backside (house-side) or frontside (street-side) shielding
- Powered by Keystone 0–10V dimming LED driver featuring 12V AUX power tap, 6kV surge protection
- Ambient operating temperature: –40°C/–40°F to 50°C/122°F
- UL Certified for wet locations, IP65
- 0–10V dimming, 10% min
- Power factor: >0.95
- THD: <20%
- LED chip lifetime: L70 >100,000 hrs @ 25°C/77°F ambient fixture temp
- Meets FCC Part 15, Part B, Class A standards for conducted and radiated emissions

ELECTRICAL SPECIFICATIONS

Catalog Number	Wattage	Lumens	Efficacy	Dimming	Color Temp	CRI	Dist Type*	Input Voltage	Rated Life	Legacy Equivalent	Housing Color**	Additional Feature
KT-ALED210-L1-2-NM-840-VDIM	210W	28,980 lm	138 lm/W	0–10V	4000K	>80	II	120–277V	50,000 hrs	400–750W	Bronze	10kV external surge protection included
KT-ALED210-L1-2-NM-850-VDIM		29,400 lm	140 lm/W		5000K		II					
KT-ALED210-L1-3-NM-840-VDIM		29,190 lm	139 lm/W		4000K		III					
KT-ALED210-L1-3-NM-850-VDIM		29,610 lm	141 lm/W		5000K		III					
KT-ALED210-L1-4-NM-840-VDIM		29,190 lm	139 lm/W		4000K		IV					
KT-ALED210-L1-4-NM-850-VDIM		29,610 lm	141 lm/W		5000K		IV					
KT-ALED210-L1-5-NM-840-VDIM		29,400 lm	140 lm/W		4000K		V					
KT-ALED210-L1-5-NM-850-VDIM		29,820 lm	142 lm/W		5000K		V					

* Fixtures with Type 2 (II) and Type 4 (IV) optics are available and assembled to order. Lead times may apply. Please see catalog number breakdown for full ordering code details.

** Fixtures (and mounts) with alternate housing colors are available and made to order. Extended lead times apply. Please see catalog number breakdown for full ordering code details.

KT-ALED210-L1-X-NM-8XX-VDIM

LED AREA LIGHT FIXTURES

MOUNTING BRACKET OPTIONS (SOLD SEPARATELY)

SLIP FITTER MOUNT

Fits 2 3/8" tenon; Bronze

Catalog Number	UPC	Easy Code
KT-ALED-SF-1-KIT	843654131641	JRH-74

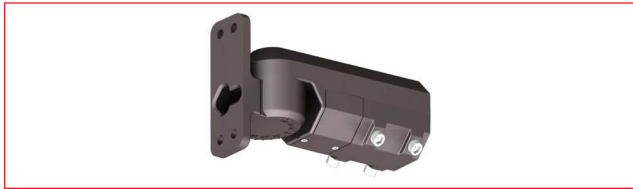

ADJUSTABLE POLE MOUNT

For round or square pole; Bronze

Catalog Number	UPC	Easy Code
KT-ALED-PMA-1-KIT	843654131634	DAQ-87



FIXED POLE MOUNT

For round or square pole; Bronze

Catalog Number	UPC	Easy Code
KT-ALED-PM-1-KIT	843654131627	QVG-29



TRUNNION MOUNT

Bronze

Catalog Number	UPC	Easy Code
KT-ALED-TM-1-KIT	843654131658	GTH-37

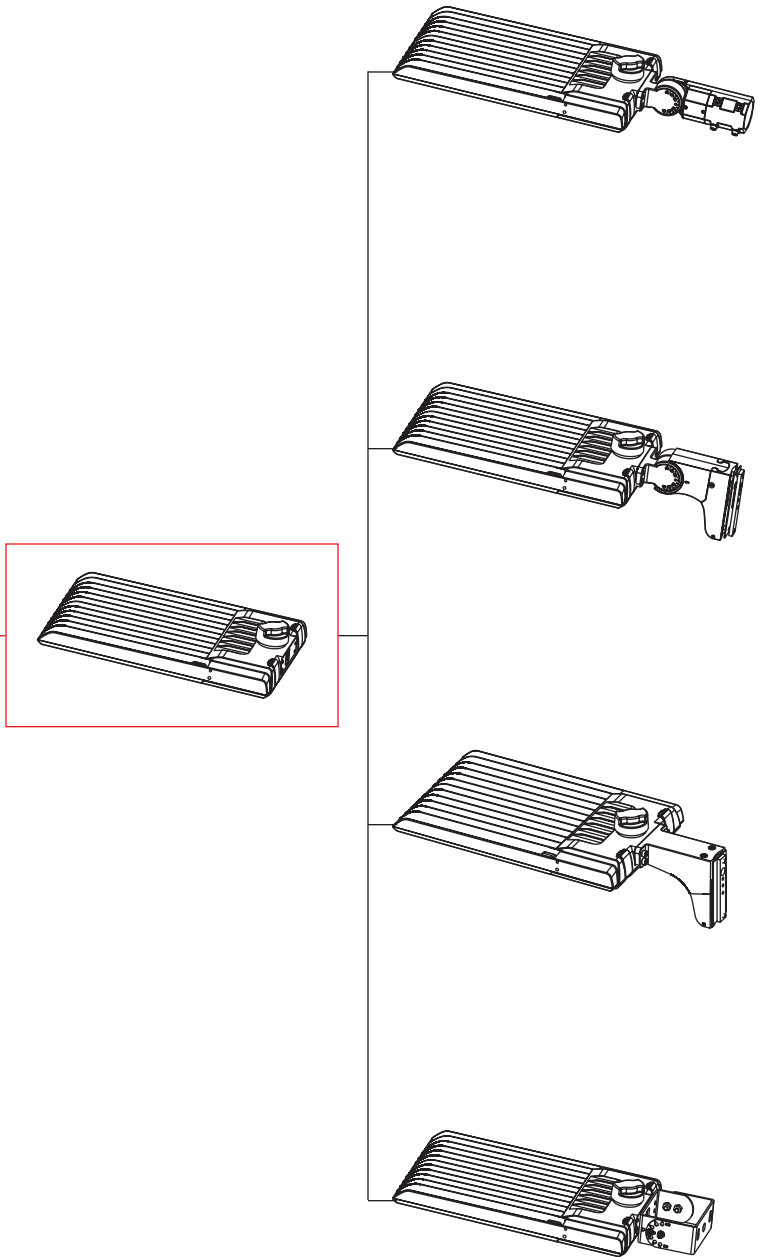
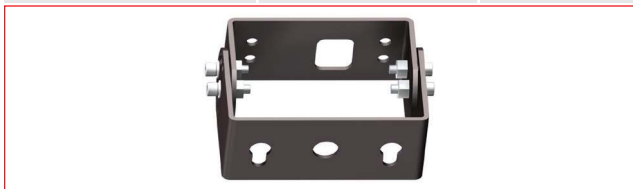

KT-ALED210-L1-X-NM-8XX-VDIM

LED AREA LIGHT FIXTURES

PHYSICAL SPECIFICATIONS

LED AREA LIGHT FIXTURE

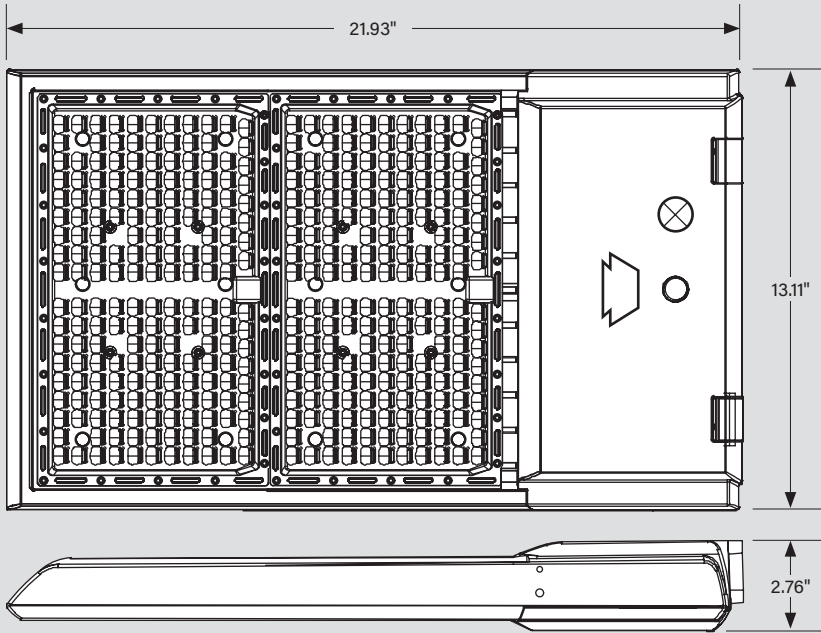

PACKAGING

Carton Quantity	1 piece
Carton Dimensions	6.1"H x 15.15"W x 27.36"L
Carton Weight	15.43 lbs

POLE MOUNT (ADJUSTABLE OR FIXED) DRILLING HOLES

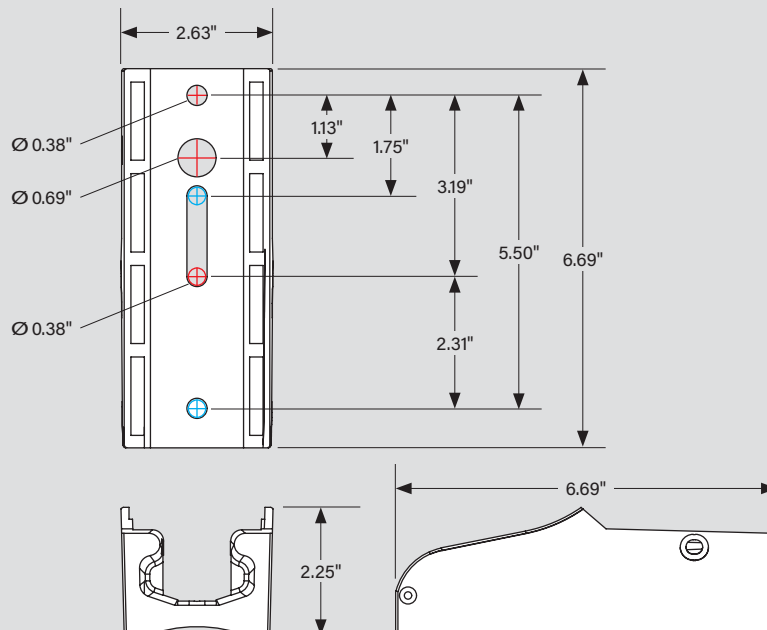

KT-ALED210-L1-X-NM-8XX-VDIM

LED AREA LIGHT FIXTURES

WIRING DIAGRAM

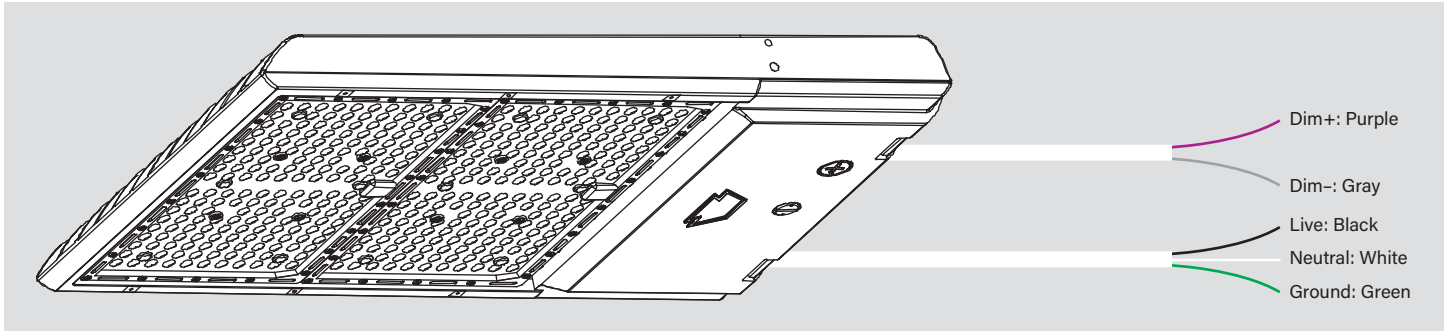

LIGHT DISTRIBUTION PATTERN

TYPE 3 (III)

Pole-mount view from above; Area light mounted at 30'

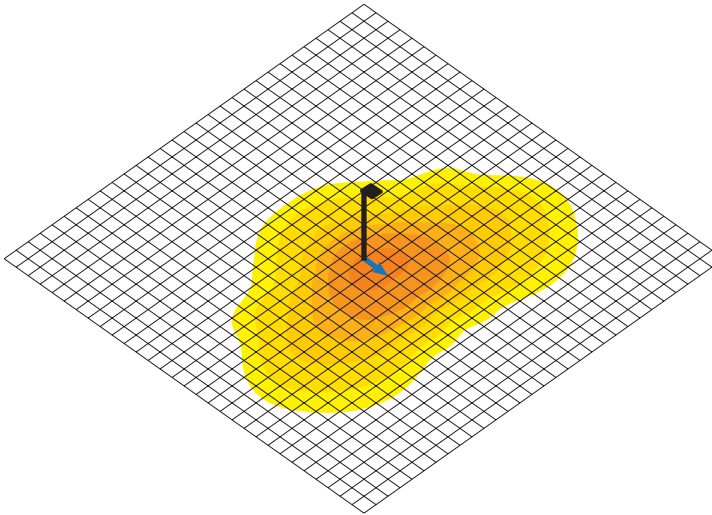

TYPE 5 (V)

Pole-mount view from above; Area light mounted at 30'

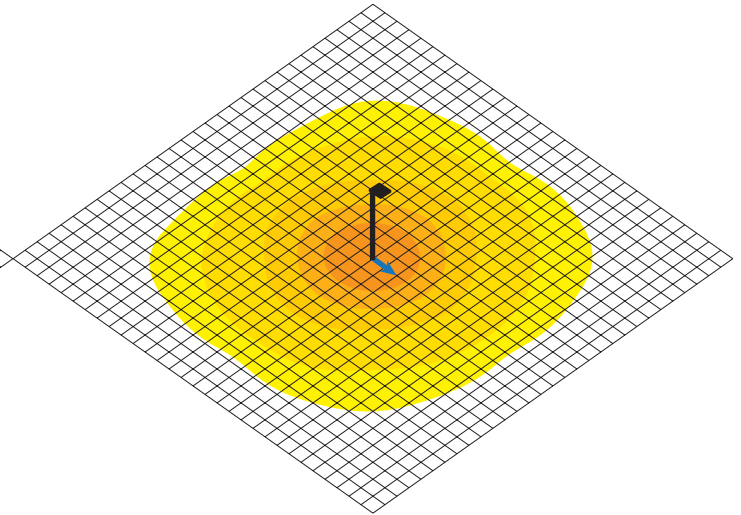

- Photometric layout for general reference only
- Grid dimension: 10 × 10 sq ft

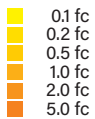

- Photometric layout for general reference only
- Grid dimension: 10 × 10 sq ft

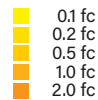

KT-ALED210-L1-X-NM-8XX-VDIM

LED AREA LIGHT FIXTURES

PHOTOMETRIC SPECIFICATIONS (TYPE 3 [III])

ISOCANDELA PLOT

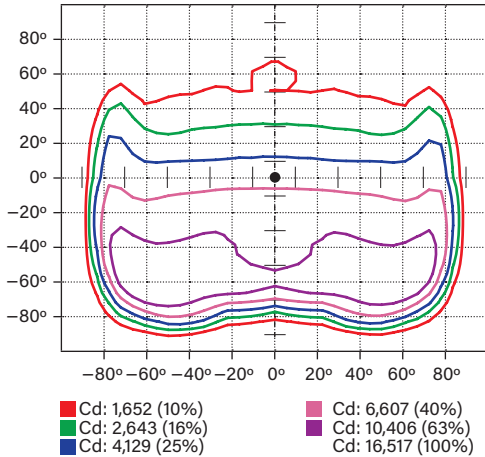

LUMINOUS INTENSITY DISTRIBUTION

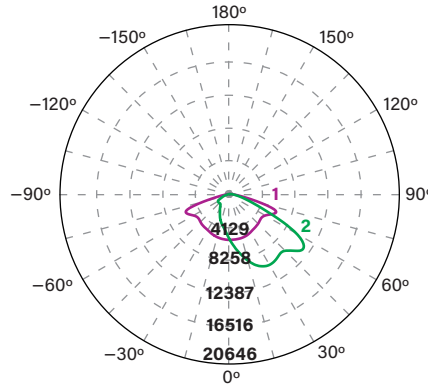

Average diffuse angle (50%): 107.2°

1 Violet C0 - C180
2 Green C90 - C270

Unit: cd

FLUX DISTRIBUTION

Zone	Lumens	% Luminaire
Forward Light	23,505 lm	79.4%
0°-30°	3,279 lm	11.1%
30°-60°	11,305 lm	38.2%
60°-80°	8,383 lm	28.3%
80°-90°	538 lm	1.8%
Back Light	6,083 lm	20.6%
0°-30°	1,663 lm	5.6%
30°-60°	2,807 lm	9.5%
60°-80°	1,495 lm	5.1%
80°-90°	118 lm	0.4%
Up Light	0 lm	0.0%
90°-100°	0 lm	0.0%
100°-180°	0 lm	0.0%

BUG* Rating

Asymmetrical Luminaire Types

Type I, II, III, IV B3 U0 G4

Quadrilateral Symmetrical Luminaire Types

Type V, Area Light B3 U0 G4

* Backlight, Uplight, Glare

PHOTOMETRIC SPECIFICATIONS (TYPE 5 [V])

ISOCANDELA PLOT

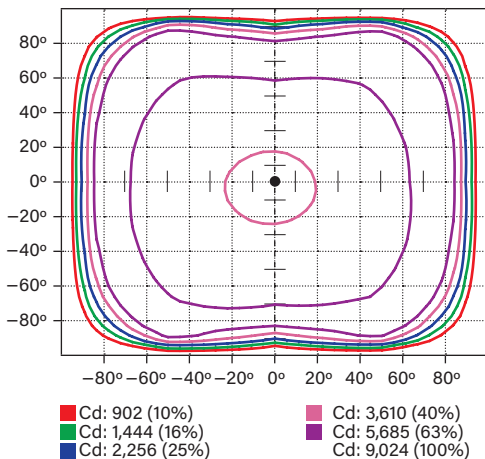

LUMINOUS INTENSITY DISTRIBUTION

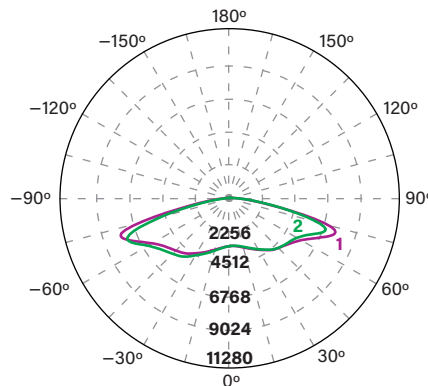

Average diffuse angle (50%): 155.5°

1 Violet C0 - C180
2 Green C90 - C270

Unit: cd

FLUX DISTRIBUTION

Zone	Lumens	% Luminaire
Forward Light	14,472 lm	48.9%
0°-30°	1,518 lm	5.1%
30°-60°	5,638 lm	18.1%
60°-80°	6,347 lm	21.5%
80°-90°	1,239 lm	4.2%
Back Light	15,114 lm	51.1%
0°-30°	1,597 lm	5.4%
30°-60°	5,872 lm	19.8%
60°-80°	6,799 lm	23.0%
80°-90°	847 lm	2.9%
Up Light	0 lm	0.0%
90°-100°	0 lm	0.0%
100°-180°	0 lm	0.0%

BUG* Rating

Asymmetrical Luminaire Types

Type I, II, III, IV B5 U0 G5

Quadrilateral Symmetrical Luminaire Types

Type II B5 U0 G5

* Backlight, Uplight, Glare

KT-ALED210-L1-X-NM-8XX-VDIM

LED AREA LIGHT FIXTURES

PHOTOMETRIC SPECIFICATIONS (TYPE 4 [IV])

ISOCANDELA PLOT

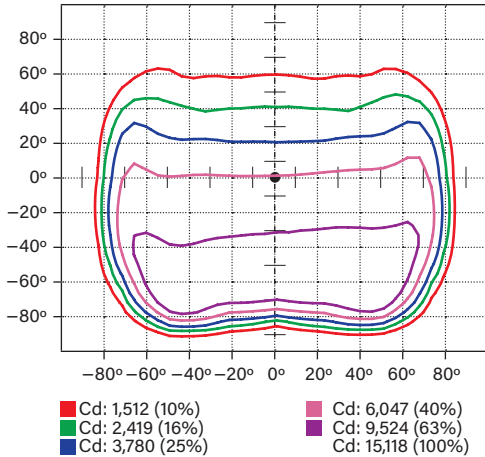

LUMINOUS INTENSITY DISTRIBUTION

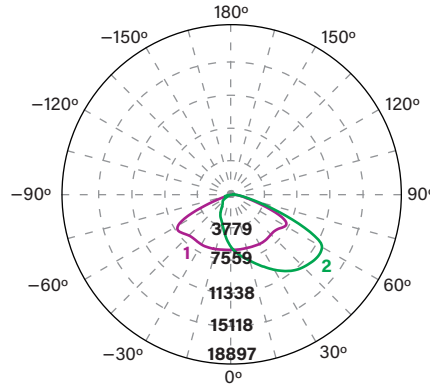

Average diffuse angle (50%): 104.7°

1 Violet C0 - C180
2 Green C90 - C270
Unit: cd

FLUX DISTRIBUTION

Zone	Lumens	% Luminaire
Forward Light	22,653 lm	76.2%
0°-30°	3,215 lm	10.8%
30°-60°	11,253 lm	37.8%
60°-80°	7,764 lm	26.1%
80°-90°	421 lm	1.4%
Back Light	7,087 lm	23.8%
0°-30°	1,924 lm	6.5%
30°-60°	3,478 lm	11.7%
60°-80°	1,525 lm	5.1%
80°-90°	161 lm	0.5%
Up Light	0 lm	0.0%
90°-100°	0 lm	0.0%
100°-180°	0 lm	0.0%

BUG* Rating

Asymmetrical Luminaire Types

Type I, II, III, IV	B3 U0 G4
---------------------	----------

Quadrilateral Symmetrical Luminaire Types

Type V, Area Light	B3 U0 G4
--------------------	----------

* Backlight, Uplight, Glare

PHOTOMETRIC SPECIFICATIONS (TYPE 2 [II])

ISOCANDELA PLOT

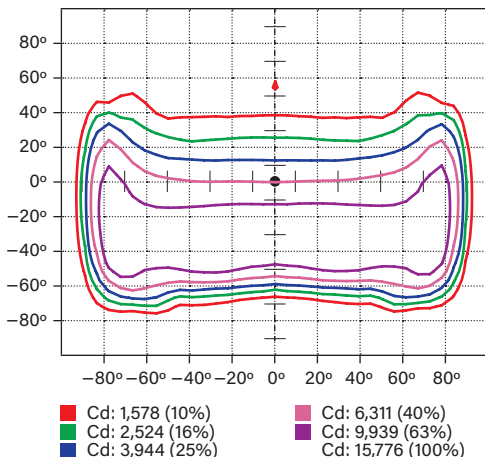

LUMINOUS INTENSITY DISTRIBUTION

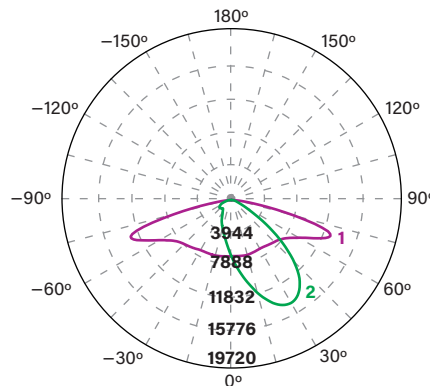

Average diffuse angle (50%): 103.4°

1 Violet C0 - C180
2 Green C90 - C270
Unit: cd

FLUX DISTRIBUTION

Zone	Lumens	% Luminaire
Forward Light	23,114 lm	77.1%
0°-30°	4,324 lm	14.4%
30°-60°	12,905 lm	43.0%
60°-80°	5,557 lm	18.5%
80°-90°	329 lm	1.1%
Back Light	6,874 lm	22.9%
0°-30°	1,779 lm	5.9%
30°-60°	2,960 lm	9.9%
60°-80°	1,980 lm	6.6%
80°-90°	155 lm	0.5%
Up Light	0 lm	0.0%
90°-100°	0 lm	0.0%
100°-180°	0 lm	0.0%

BUG* Rating

Asymmetrical Luminaire Types

Type I, II, III, IV	B3 U0 G3
---------------------	----------

Quadrilateral Symmetrical Luminaire Types

Type V, Area Light	B3 U0 G3
--------------------	----------

* Backlight, Uplight, Glare













KT-ALED210-L1-X-NM-8XX-VDIM

LED AREA LIGHT FIXTURES

EPA SPECIFICATIONS

Large-Size Fixture Housing

Conditions: Horizontal winds only for calculations. Worst case total projected area used for calculations. All drag coefficients are set as worst case 1.2. For details on exact EPA calculations and assumptions, please contact productsupport@keystonetech.com

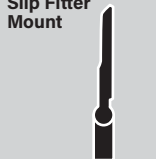
EPA Calcs (1.2*ft^2 View)		Single Fixture	2 Fixtures at 90°	2 Fixtures at 180°	3 Fixtures at 90°	3 Fixtures at 120°	4 Fixtures at 90°	2 Fixtures Side-by-Side	3 Fixtures Side-by-Side	4 Fixtures Side-by-Side
Mounting Application	Fixture Position									
Adjustable Pole Mount 	Horizontal	0.62 sq. ft.	0.90 sq. ft.	1.24 sq. ft.	1.42 sq. ft.	1.48 sq. ft.	1.42 sq. ft.	0.74 sq. ft.	1.11 sq. ft.	1.48 sq. ft.
Adjustable Pole Mount 	45°	1.85 sq. ft.	2.43 sq. ft.	1.85 sq. ft.	3.01 sq. ft.	4.42 sq. ft.	3.01 sq. ft.	3.70 sq. ft.	5.55 sq. ft.	7.40 sq. ft.
Slip Fitter Mount 	Horizontal	0.60 sq. ft.	0.98 sq. ft.	1.20 sq. ft.	1.53 sq. ft.	1.57 sq. ft.	1.53 sq. ft.	0.86 sq. ft.	1.30 sq. ft.	1.73 sq. ft.
Slip Fitter Mount 	45°	1.92 sq. ft.	2.51 sq. ft.	1.92 sq. ft.	3.09 sq. ft.	4.39 sq. ft.	3.09 sq. ft.	3.84 sq. ft.	5.76 sq. ft.	7.68 sq. ft.
Slip Fitter Mount 	Vertical	2.59 sq. ft.	3.19 sq. ft.	2.59 sq. ft.	3.80 sq. ft.	4.07 sq. ft.	3.80 sq. ft.	5.18 sq. ft.	7.77 sq. ft.	10.35 sq. ft.

KT-ALED210-L1-X-NM-8XX-VDIM

LED AREA LIGHT FIXTURES

ACCESSORIES (SOLD SEPARATELY)

TWIST-LOCK AREA LIGHT CONTROL

Catalog Number	Description	UPC	Easy Code
KT-TLP-UV-3PN	NEMA Type Twist-Lock 3-Pin Photocell 120-277V, 1800VA Max; Blue Housing	843654131825	NQT-46



GLARE SHIELD

Catalog Number	Description	UPC	Easy Code
KT-ALED-GS-L1-KIT	Reversible Glare Shield Kit; Large (fits "L1" fixture bodies); Bronze Housing	843654131818	LAI-36



MICROWAVE OCCUPANCY SENSOR

Catalog Number	Description	UPC	Easy Code
KTS-MW3-12V-PKO	12V Microwave Occupancy Sensor	843654130637	TRM-32



REMOTE CONTROL

Catalog Number	Description	UPC	Easy Code
KTS-MW3-REMOTECONTROL	Remote Control for KTS-MW3-12V-XX Sensors, Sets/adjusts all sensor performance parameters	843654132020	XSR-61





KT-ALED210-L1-X-NM-8XX-VDIM

LED AREA LIGHT FIXTURES

ORDERING INFORMATION

ORDER CODE	PACK QTY.	UPC	Easy Code	DLC PRODUCT ID
KT-ALED210-L1-3-NM-840-VDIM	1	843654131481	EVD-02	PAFOTHKH
KT-ALED210-L1-3-NM-850-VDIM	1	843654131498	FPL-07	POQELB0G
KT-ALED210-L1-5-NM-840-VDIM	1	843654131504	GEE-35	P6AFQMFR
KT-ALED210-L1-5-NM-850-VDIM	1	843654131511	QNY-02	PI17AI88

CATALOG NUMBER BREAKDOWN

KT-ALED210-L1-X-NM-8XX-VDIM

1	2	3	4	5	6	7	8	9	10	11	12	13
1 Keystone Technologies	2 Fixture Type			5 Size / Shape			6 Style / Design Designation					
2 Fixture Type	A Area Light			L Large			1 Series 1					
3 LED Technology	7 Distribution Type			8 Mounting			9 CRI			10 Color Temp		
4 Wattage	2 Type 2 (II)			NM No Mounting			8 >80			40 4000K		
5 Size / Shape	3 Type 3 (III)			4 Type 4 (IV)			5 Type 5 (V)			50 5000K		
6 Style / Design Designation	11 Dimming			12 Housing Color			13 Options					
7 Distribution Type	VDIM 0-10V			Blank Bronze			Blank No Options					
8 Mounting				B Black			/7PRS 7-Pin Receptacle and Shorting Cap installed					
9 CRI				W White			/MW3 Factory-installed Microwave Sensor					
10 Color Temp												
11 Dimming												
12 Housing Color												
13 Options												