



# XFIT

## KT-MSLED19-2-8XX-VDIM-P

### LED MICROSTRIP FIXTURE

#### DESCRIPTION

2' 19W LED Microstrip Fixture | 120-277V Input | Frosted Lens | 0-10V Dimming | Premium Series

#### APPLICATION

Used for commercial, retail, and residential strip applications



**10 YEAR**  
LIMITED WARRANTY



#### PRODUCT FEATURES

- Powered by Keystone 0-10V dimming LED drivers
- Post-painted steel body; PMMA lens
- Smooth diffused lens for an even appearance
- 0-10V dimming, 10% minimum
- Compatible with Keystone 480-277V step down transformers
- Compatible with Keystone occupancy sensors
- Ambient operating temperature: -20°C/-4°F to 50°C/122°F
- Available with Keystone's SmartLoop Bluetooth™ mesh wireless control system as an integral luminaire level lighting control, with features such as high-end trim, grouping, occupancy/vacancy sensing, and scheduling.
- UL Listed 1598: Suitable for dry and damp locations
- THD: < 20%
- Power factor > 0.95
- L70 > 50,000 hours

#### PRODUCT SPECIFICATIONS

Catalog Number	Color Temperature	Nominal Length	Input Voltage	Wattage	CRI	Lumen Output	Efficacy
KT-MSLED19-2-835-VDIM-P	3500K	2 ft.	120-277V	19W	> 82.0	2,470 lm	130 lm/W
KT-MSLED19-2-840-VDIM-P	4000K	2 ft.	120-277V	19W	> 82.0	2,489 lm	131 lm/W
KT-MSLED19-2-850-VDIM-P	5000K	2 ft.	120-277V	19W	> 82.0	2,508 lm	132 lm/W

#### PHOTOMETRIC SPECIFICATIONS

##### ISOCANDELA PLOT

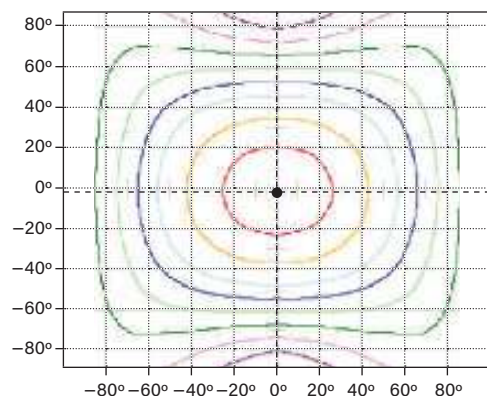

■ Cd: 628, 90%	■ Cd: 279, 40%
■ Cd: 523, 75%	■ Cd: 209, 30%
■ Cd: 419, 60%	■ Cd: 140, 20%
■ Cd: 349, 50%	■ Cd: 70, 10%

----- Point of Max Cd: 698.5

##### ZONAL LUMEN SUMMARY

Zone	Lumens	% Luminaire
0-30	539.7	22.1%
0-40	884.5	36.2%
0-60	1,588.7	65%
60-90	652.5	26.7%
70-100	459.8	18.8%
90-120	175.4	7.2%
0-90	2,241.2	91.7%
90-180	203.4	8.3%
0-180	2,444.6	100%



# KT-MSLED19-2-8XX-VDIM-P

## LED MICROSTRIP FIXTURE

### PHYSICAL SPECIFICATIONS

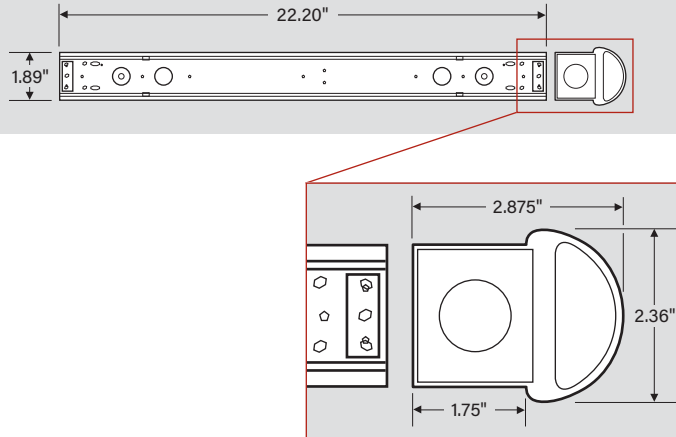

### ACCESSORIES

#### SENSORS

Factory-Installable OR Field-Installable (field-installable purchased separately)

✓	SUFFIX*	CATALOG NUMBER	DESCRIPTION	UPC	EASY CODE
	/PIR	KTS-PIR2-UV-KO	High Bay PIR Motion Sensor, 120-347V Input. Adjustable Standby Dim level, Hold Times & Daylight Threshold controls. Fixture Mount via 1/2 inch KO	843654123288	IOF-04



Smart Loop PIR Sensor  
KTS-PIR2-UV-KO

**Note:** Keystone SmartLoop is a DLC Qualified Network Lighting Control solution, offering advanced functions such as complete wireless control, zoning, high-end trim, occupancy/vacancy sensing, scene setting, and scheduling. To learn more about SmartLoop, please visit <http://www.keystonetech.com/smartloop>.

\* FOR FACTORY INSTALLATION OF ACCESSORY, ADD SUFFIX TO FIXTURE PART NUMBER (SEE ORDERING EXAMPLES AND INSTRUCTIONS ON LAST PAGE OF SPEC SHEET).

(Accessories continued on next page)

# KT-MSLED19-2-8XX-VDIM-P

## LED MICROSTRIP FIXTURE

**ACCESSORIES** (continued)

**CORD SETS**

Factory-Installable OR Field-Installable (field-installable purchased separately)

✓	SUFFIX*	CATALOG NUMBER	DESCRIPTION	UPC	EASY CODE
	/515P6	KT-CS-515P-6-18/3	Cord set; 125V NEMA 5-15P; straight blade plug ;6' SJTOW cable; 18/3 wire	843654140124	UKH-26
	/L715P10	KT-CS-L715P-10-16/3	Cord set; 277V NEMA L7-15P; twist lock plug; 10' SJTOW cable; 16/3 wire	843654140131	SFV-88
	/L615P10	KT-CS-L615P-10-16/3	Cord set; 250V NEMA L6-15P; twist lock plug; 10' SJTOW cable; 16/3 wire	843654140148	ZQS-05
	/L515P10	KT-CS-L515P-10-16/3	Cord set; 125V NEMA L5-15P; twist lock plug; 10' SJTOW cable; 16/3 wire	843654140155	GVH-22
	/L715P6	KT-CS-L715P-6-16/3	Cord set; 277V NEMA L7-15P; twist lock plug; 6' SJTOW cable; 16/3 wire	843654140162	DVU-44
	/L615P6	KT-CS-L615P-6-16/3	Cord set; 250V NEMA L6-15P; twist lock plug; 6' SJTOW cable; 16/3 wire	843654140179	LCW-66
	/L515P6	KT-CS-L515P-6-16/3	Cord set; 125V NEMA L5-15P; twist lock plug; 6' SJTOW cable; 16/3 wire	843654140186	POC-82
	/NP10	KT-CS-NP-10-16/3	Cord; no plug; inners 1/2" strip on both ends; 10' SJTOW cable; 16/3 wire	843654140193	YOH-90
	/NP6	KT-CS-NP-6-16/3	Cord; no plug; inners 1/2" strip on both ends; 6' SJTOW cable; 16/3 wire	843654140216	HUB-73
	/NP15	KT-CS-NP-15-16/3	Cord; no plug; inners 1/2" strip on both ends; 15' SJTOW cable; 16/3 wire	843654140209	EYD-18

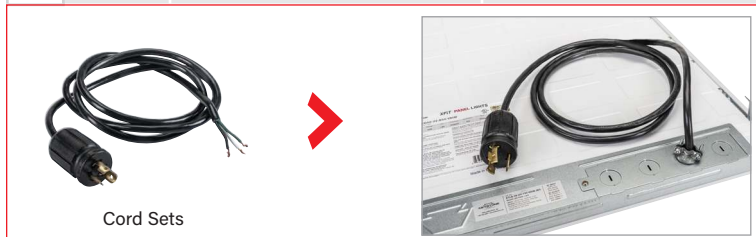

\* FOR FACTORY INSTALLATION OF ACCESSORY, ADD SUFFIX TO FIXTURE PART NUMBER (SEE ORDERING EXAMPLES AND INSTRUCTIONS ON LAST PAGE OF SPEC SHEET).  
NOTE: FOR CORD SETS NOT LISTED HERE, PLEASE CONTACT YOUR KEYSTONE SALES REP.

**MOUNTS AND BRACKETS**

Field-Installable / Field-Use ONLY (purchased separately)

CATALOG NUMBER	DESCRIPTION	UPC	EASY CODE
KT-MSLED-VH-KIT	V-Hook and Chain Kit for Keystone Micro LED Strip fixtures. Includes (2) V-Hooks and (2) chains 40in long	843654121031	YAK-04
KT-MSLED-LSM-KIT	Linking Surface Mount Kit for MSLED fixtures. Includes End to End Metal bracket and KO grommet	843654126883	BCV-03





# KT-MSLED19-2-8XX-VDIM-P

## LED MICROSTRIP FIXTURE

### ORDERING INFORMATION

Order Code	Pack Quantity	UPC	Easy Code	DLC PRODUCT ID
KT-MSLED19-2-835-VDIM-P	1	843654101026	RVH-24	PGL5FZ5X
KT-MSLED19-2-840-VDIM-P	1	843654101033	MOE-16	P28R29TJ
KT-MSLED19-2-850-VDIM-P	1	843654101040	GVO-94	PZMBTS7I

### CATALOG NUMBER BREAKDOWN

# KT-MSLED19-2-8XX-VDIM-P

1 2 3 4 5 6 7 8

- 1 Keystone Technologies
- 2 LED Microstrip Fixture
- 3 Wattage
- 4 2' Nominal Length
- 5 80 CRI
- 6 Color Temperature
- 7 0-10V Dimming
- 8 Premium Series

### ORDERING EXAMPLES

FIXTURE WITH MULTIPLE FACTORY-INSTALLED ACCESSORIES\*

KT-MSLED19-2-8XX-VDIM-P /PIR /NP10 /VH

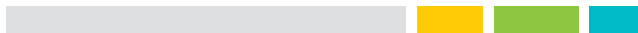

FIXTURE WITH TWO FACTORY-INSTALLED ACCESSORIES\*

KT-MSLED19-2-8XX-VDIM-P /PIR /NP10

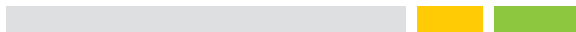

FIXTURE WITH SINGLE FACTORY-INSTALLED ACCESSORY

KT-MSLED19-2-8XX-VDIM-P /PIR

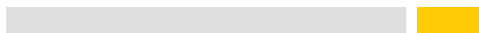

FIXTURE WITH NO FACTORY-INSTALLED ACCESSORIES

KT-MSLED19-2-8XX-VDIM-P

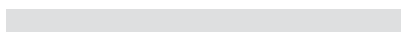

#### KEYSTONE FIXTURE

CATALOG NUMBER
KT-MSLED19-2-8XX-VDIM-P

#### SENSORS

✓ SUFFIX	CATALOG NUMBER
✓ /PIR	KTS-PIR2-UV-KO

#### CORD SETS

✓ SUFFIX	CATALOG NUMBER
✓ /NP10	KT-CS-NP-10-16/3

#### MOUNTS AND BRACKETS

✓ SUFFIX	CATALOG NUMBER
✓ /VH	KT-MSLED-VH-KIT

\* WHEN ORDERING MORE THAN ONE FACTORY-INSTALLED ACCESSORY, USE MULTIPLE SUFFIXES AS SHOWN IN THE ORDERING EXAMPLES ABOVE.  
 NOTE: ALL ACCESSORIES CAN ALSO BE ORDERED SEPARATELY FOR FIELD INSTALLATION USING JUST THEIR REGULAR CATALOG NUMBER, UPC, OR EASY CODE.