



EXTREME™

LED Flood Light



Beyond LED's EXTREME Flood light is the newest design for 2024 and comes with adjustable CCT which makes this product very unique. EXTREME flood light is ideal to replace Halogen lamps and comes with Yoke mount. This flood light is an extremely cost-effective solution, great for illuminating yards, driveways, signage and security applications.

Product Features

- Up to 170 Lumens per watt
- CCT Adjustable 4000K / 5000K / 5700K
- Dimming 0-10V
- Three distributions are available, NEMA 6H6V
- IP65 Rated
- Optional Photcell
- Yoke Mount
- Input Voltage 120-277Vac
- UL & DLC listed
- 5 Year warranty

EXTREME™ LED Flood Light



SKU #	Model #	Wattage Adjustable	Lumens	CCT Adjustable	Housing	Input Voltage	Certifications
156837	BLT-FLF(250/200/150/125)W-(40/50/57)KUV-TRMH	125W/150W 200W/250W	Max 42500Lm	4K/5K/5700K	Bronze	120-277V	UL & DLC

SKU: 156837 Specifications

Parameter	Description	Value
General Performance	Model #.	BLT-FLF(250/200/150/125)W-(40/50/57)KUV-TRMH
	Wattage Adjustable	125W / 150W / 200W / 250W
	Lumen	Up to 42500LM
	Lumen Efficacy	Up to 170LM/W
	Color Temperature	4000K / 5000K / 5700K
	CRI (Ra)	>70
	Beam Angle	6H6V
Electrical	Input Voltage	120-277Vac
	Frequency	50/60Hz
	Dimming	0-10V
	Optional Accessory	Photocell
	PF (Tolerance: -3%)	98%
	THD (Tolerance : +5%)	20%
	Driver Model	SS-240NH-E260BHB
	Driver Surge protection	6KV
	Operating Temperature	-40°C to 45°C
	Storage Temperature	-40°C to 45°C
	Operating Humidity	10%RH-90%RH
Physical	Storage Humidity	-10°C-65°C, 0%-90RH24hrs
	LED Brand	Nationstar
	LED Type	SMD2835
	LED QTY	648 Pcs
	Housing	Die-Cast Aluminum
Qualification	Housing Color	Bronze
	IP Rating	IP65
	Warranty	5 Year



EXTREME™

LED Flood Light

Correlated Color Temperature (CCT)

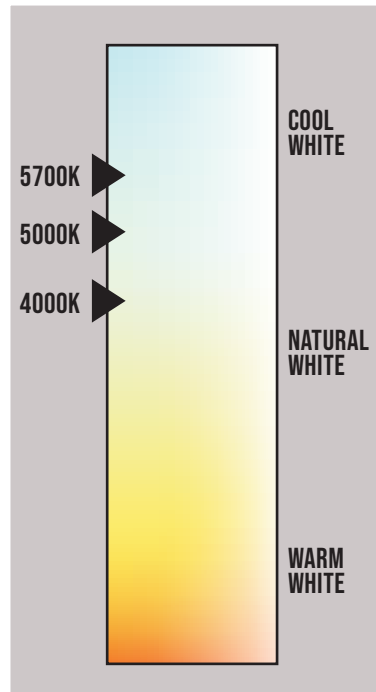

Dimensions

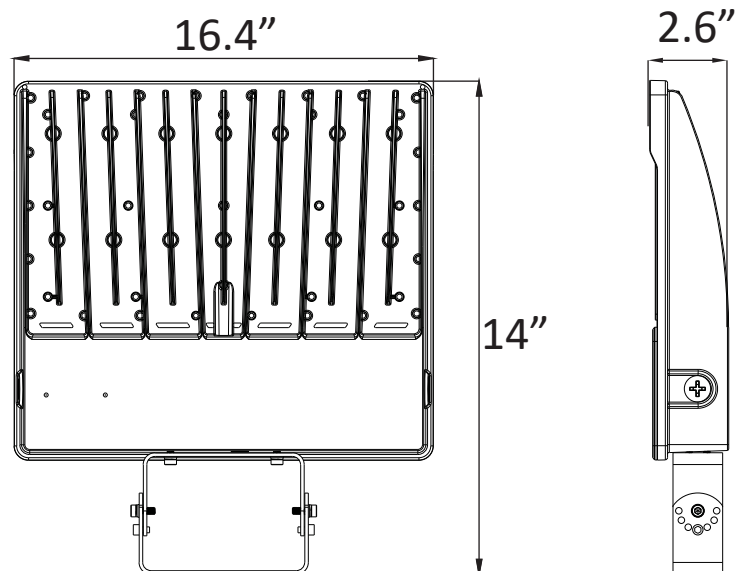

EXTREME™ LED Flood Light



Wattage & CCT Setting

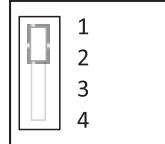

Wattage Setting

Adjustable Wattage
125W/150W/200W/250W Default Setting

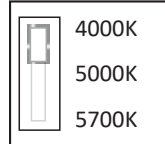

CCT Adjustable

CCT Adjustable
4000K/5000K/5700K Default Setting

Optional Accessories



XPCKit-UNV27V

Twist-lock Photcell Kit (with receptacle) for
X-FLF(250/200/150/125)W, at AC120-277V



EXTREME™

LED Flood Light

Photometric Data

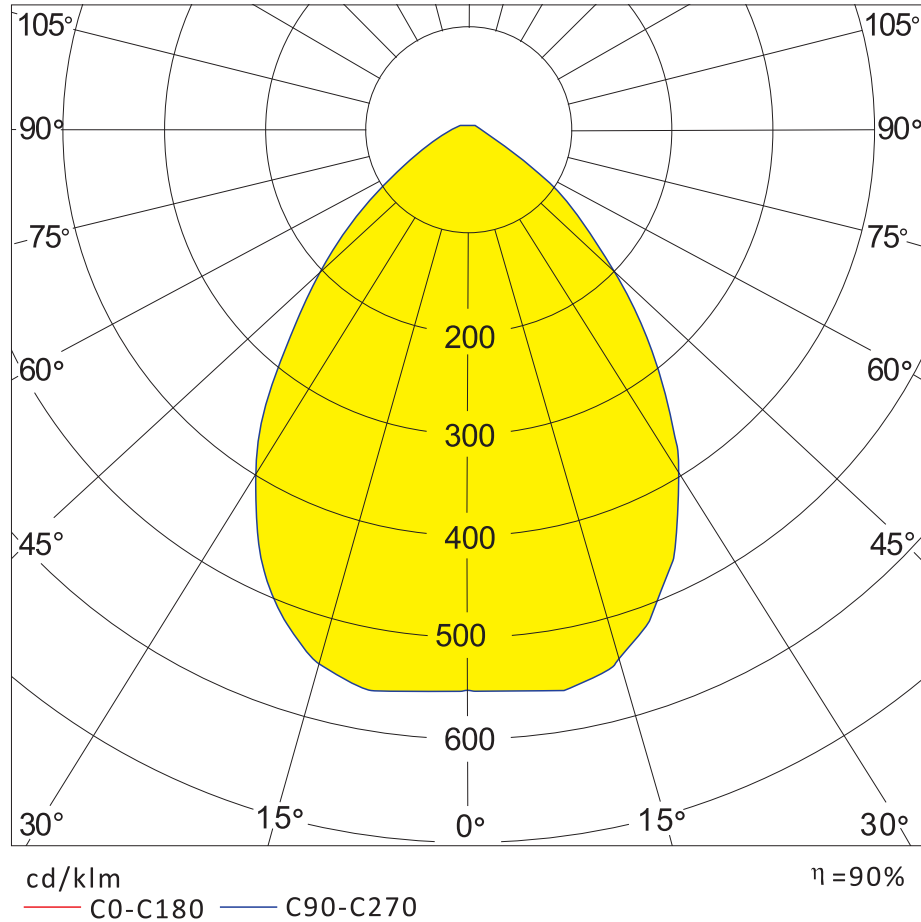

NEMA 6H6V

for 250W

EXTREME™

LED Flood Light



Installation

Upon receipt of fixture, thoroughly inspect for any freight damage. All damage should be reported to the delivery carrier. Compare the catalog description listed on the packing slip with the fixture label on the inside of the housing to be sure you have received the correct merchandise.

READ AND FOLLOW THESE SAFETY INSTRUCTIONS!

- To reduce the risk of death, personal injury or property damage from fire, electric shock, falling parts, cuts/abrasions, and other hazards please read all warnings and instructions included with and on the fixture box and all fixture labels.
- Before installing, servicing, or performing routine maintenance on this equipment, follow these general precautions.
- Commercial installation, service and maintenance of luminaires should be performed by a qualified licensed electrician.
- For Residential installation: If you are unsure about the installation or maintenance of the luminaires, consult a qualified licensed electrician and check your local electrical code.
- Maintenance of the luminaires should be performed by person(s) familiar with the luminaires' construction and operation and any hazards involved. Regular fixture maintenance programs are recommended.
- This fixture is intended to be connected to a properly installed and grounded UL listed junction box.
- It will occasionally be necessary to clean the outside of the refractor/lens. Refractor/lens should be washed in a solution of warm water and any mild, non-abrasive household detergent, rinsed with clean water and wiped dry. Should optical assembly become dirty on the inside, wipe refractor/lens and clean in above manner, replacing damaged gaskets as necessary.
- DO NOT INSTALL DAMAGED PRODUCT! This luminaire has been properly packed so that no parts should have been damaged during transit. Inspect to confirm.
- Any part damaged or broken during or after assembly should be replaced.
- These instructions do not purport to cover all details or variations in equipment nor to provide every possible contingency to meet in connection with installation, operation, or maintenance. Should further information be desired or should particular problems arise which are not covered sufficiently for the purchaser's or owner's purposes, this matter should be referred to manufacturer.

WARNING RISK OF ELECTRIC SHOCK

- ▶ Disconnect or turn off power before installation or servicing.
- ▶ Verify that supply voltage is correct by comparing it with the luminaire label information.
- ▶ Make all electrical and grounded connections in accordance with the National Electrical Code (NEC) and any applicable local code requirements.
- ▶ All wiring connections should be capped with UL approved wire connectors.

CAUTION RISK OF INJURY

- ▶ Wear gloves and safety glasses at all times when removing luminaire from carton, installing, servicing or performing maintenance.
- ▶ Avoid direct eye exposure to the light source while it is on.



EXTREME™

LED Flood Light

Installation

WARNING RISK OF BURN

- ▶ Allow lamp/fixture to cool before handling. Do not touch enclosure, lens or light source.
- ▶ Do not exceed maximum wattage marked on luminaire label.
- ▶ Follow all manufacturer's warnings, recommendations and restrictions including but not limited to: driver type, mounting locations/methods, replacement and recycling.
- ▶ Use only lamps that comply with ANSI standards.

CAUTION RISK OF FIRE

- Keep combustible and other materials that can burn, away from lamp/lens.
- Do not operate in close proximity to persons, combustible materials, or substances affected by heat.

CAUTION RISK OF PRODUCT DAMAGE

- Never connect components under load.
- Do not mount or support these fixtures in a manner that can cut the outer jacket or damaged wire insulation.
- Unless individual product specifications deem otherwise: Never connect an LED product directly to dimmer packs, occupancy sensors, timing devices, or other control devices. LED fixtures must be powered directly off a switched circuit.
- Unless individual product specifications deem otherwise: Do not restrict fixture ventilation. Allow for some volume of airspace around the fixture. Avoid covering LED fixtures with insulation, foam, or other material that will prevent convection or cooling.
- Unless individual product specifications deem otherwise: Do not exceed fixtures' maximum ambient temperature.
- Only use the fixture in its intended location.
- LED products are polarity sensitive. Ensure proper polarity before installation.
- Electrostatic Discharge (ESD): ESD can damage LED fixtures. Personal grounding equipment must be worn during all installation or servicing of the unit.
- Do not touch individual electrical components as this can cause ESD, shorten lamp life, or alter performance.
- Some components inside the fixture may not be serviceable. If your unit requires service, stop using the unit immediately and contact an manufacture representative for assistance.
- Changes or modifications not expressly approved by manufacturer will void the product warranty.
- Always read the fixtures' complete installation instructions prior to installation for any additional fixture-specific warnings.

» PACKAGE

1. LED Flood Light.
2. Installation Instruction.
3. Installation hardware.

EXTREME™ LED Flood Light



Installation

» INSTALLATION INSTRUCTIONS

• 180° 1/2"NPSM Knuckle Mount

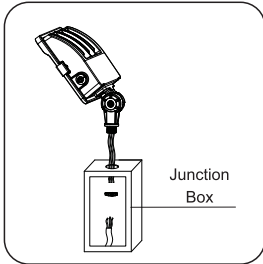

1. Put the electrical wiring into the Junction Box

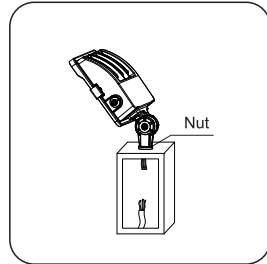

1. Tighten the Nut, connect the electrical wiring according to the instruction

Caution: turn off the electricity before installation

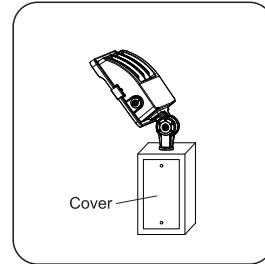

1. Tighten the Junction box cover

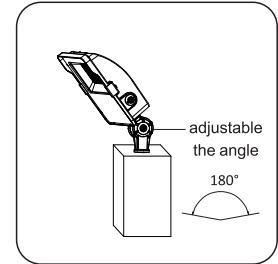

1. Use this screw to adjust the bracket angle, Rotate 180° degreenction box cover

• Yoke Mount

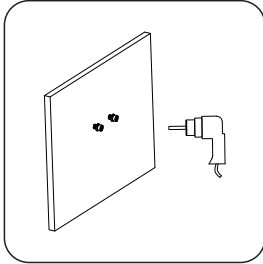

1. Drilling, and install expansion screw until the middle side

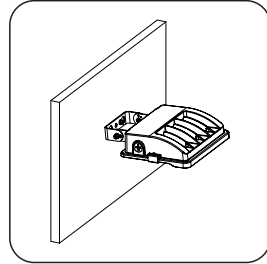

1. Tighten the Nuts

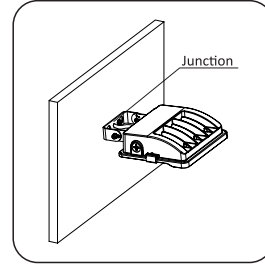

1. Connect the electrical wiring according to the instruction,
Caution: turn off the electricity before installation

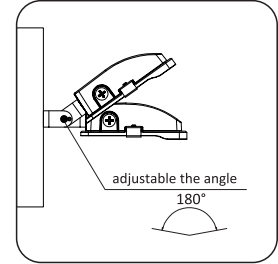

1. Use this screw to adjust the bracket angle, Rotate 180° degreenction box cover

• Slip fitter Mount

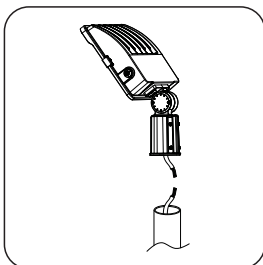

1. Connect wires and take safety measures

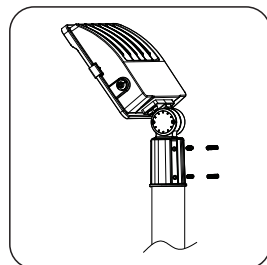

1. Install the lamp into the pole, Tighten the screws

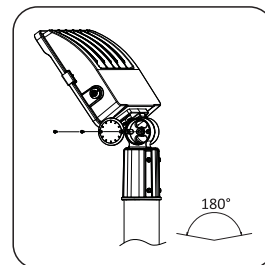

1. Open the lid, Adjust The Angle

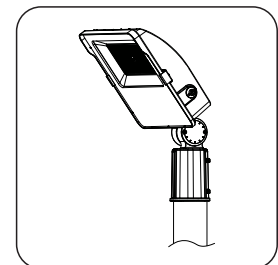

1. Install the cover



EXTREME™ LED Flood Light

Installation

» TROUBLESHOOTING

1. Check that the line voltage at the fixture is correct. Refer to wiring directions.
2. Is the fixture grounded properly.
3. Be sure the photocell, if used, is functioning properly.

» WATTAGE & CCT ADJUSTABLE

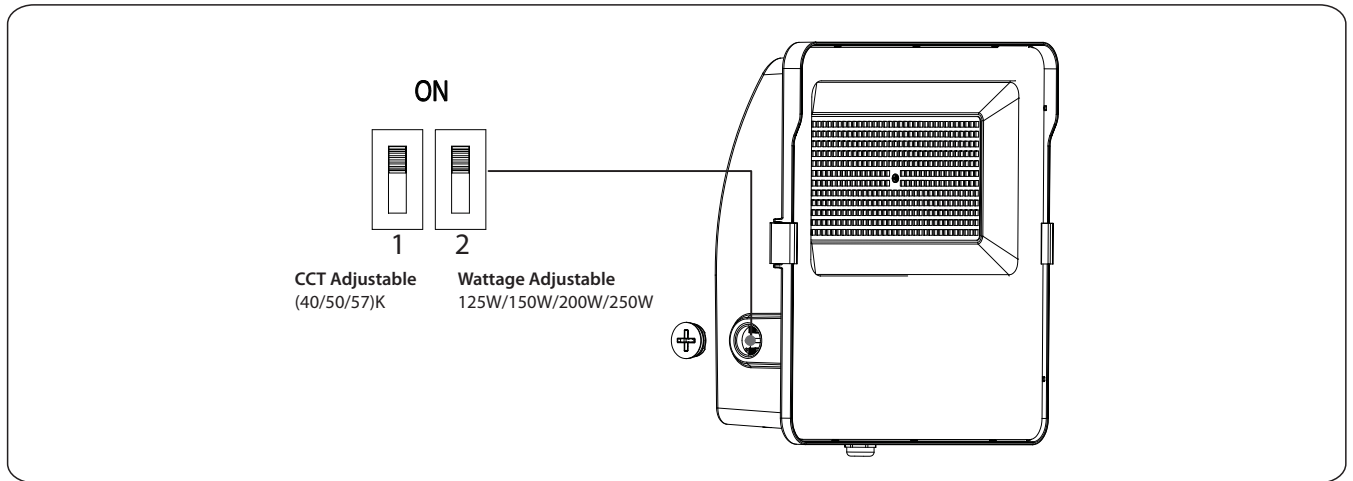

» WIRING DIAGRAM

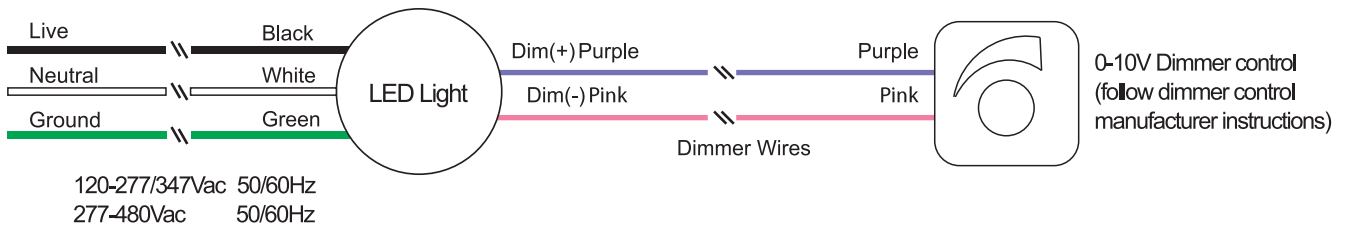

Drilling Patterns

Knuckle Mount for
FLF 30-63W

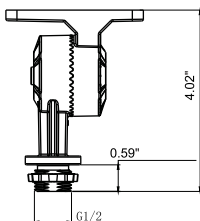

Trunnion Mount for
FLF 30-63W

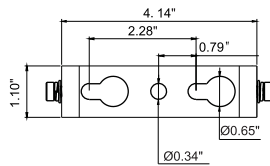

Trunnion Mount for
FLF 108-250W

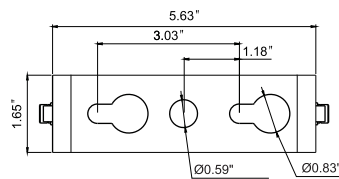

Slipfitter Mount for
FLF 108-250W

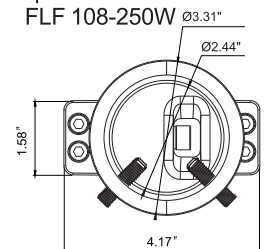

EXTREME™ LED Flood Light



Packaging

SKU	Box Type	Dimensions (Inches)	Pcs/Box	Net Weight	Gross Weight
156837	Outer Box	18.11 x 15.83 x 4.57	1	9.5 LBS	11.0 LBS

Application



LED FLOOD LIGHT

Warranty

5 Year Warranty