

# Outdoor Gazebo / Gazebo extérieur / Gazebo para exteriores

## MODEL / MODÈLE / MODELO A102009720

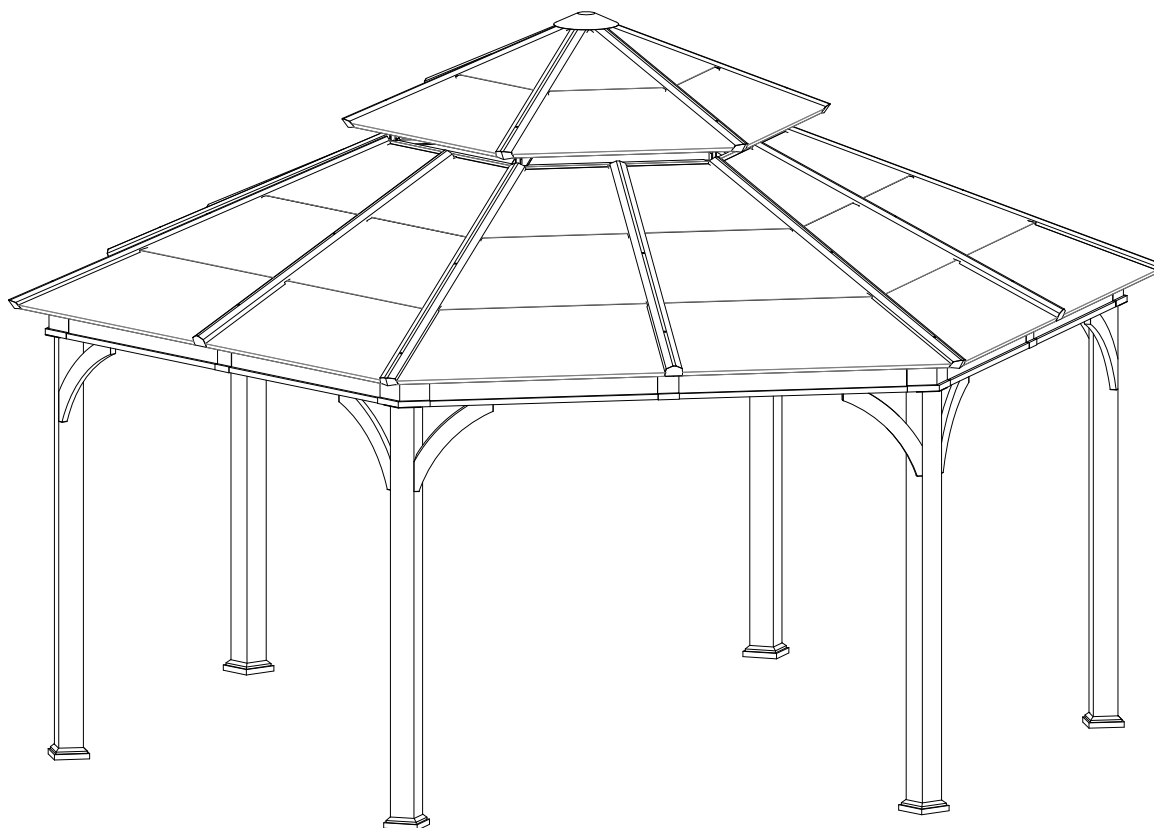

**IMPORTANT, RETAIN FOR FUTURE REFERENCE: READ CAREFULLY.**

Please check with your local governing authority / local municipal codes regarding installation of structures before assembly.

**IMPORTANT : LIRE ATTENTIVEMENT ET CONSERVER POUR CONSULTATION ULTÉRIEURE.**

Avant l'assemblage, consulter les règlements municipaux applicables à l'installation de structures semblables.

**IMPORTANTE, CONSERVE PARA FUTURA REFERENCIA: LEA CUIDADOSAMENTE.**

Por favor, antes de ensamblar, verifique con las autoridades de su localidad/municipalidad la reglamentación relativa a la instalación de estructuras.



A10200972025



**Safety Items recommended (Not Included) / Articles de sécurité recommandés (non compris) /  
Artículos de seguridad recomendados (no incluidas):**

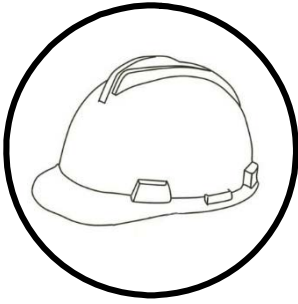

**Tools recommended (Not Included) / Outils recommandés (non compris) /  
Herramientas recomendadas (no incluidas):**

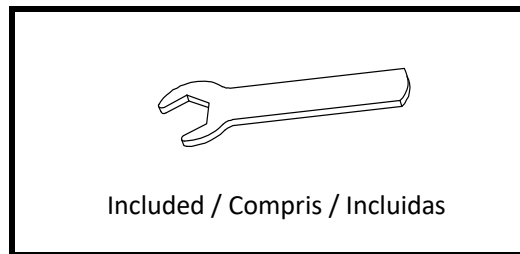
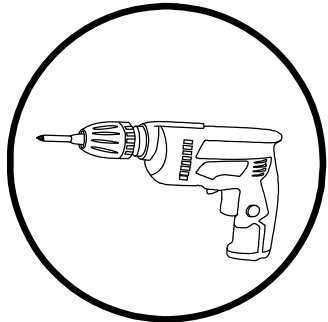
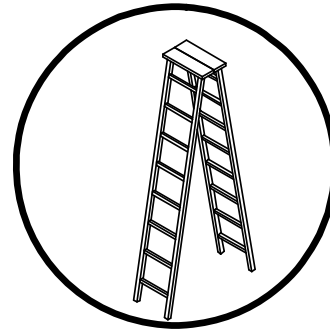
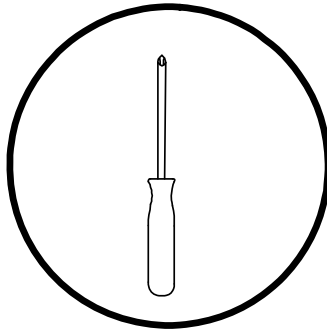
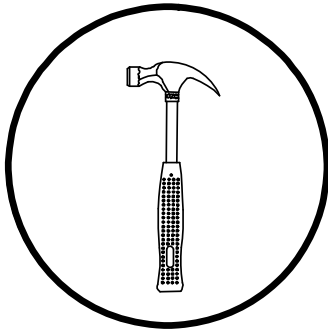

**Questions, problems, missing parts?**

Before returning to your retailer, call Sunjoy Group at 1(866) 578-6569 (English) anytime 24 hours / 7 days a week, or email to [customer.care@sunjoygroup.com](mailto:customer.care@sunjoygroup.com) or visit [www.sunjoyonline.com](http://www.sunjoyonline.com) for more information or assistance.

**Vous avez des questions? Il vous manque des pièces?**

Avant de retourner chez le détaillant, appelez Sunjoy Group au 1-866-578-6569 (anglais) à n'importe quelle heure, ou envoyez un email à [customer.care@sunjoygroup.com](mailto:customer.care@sunjoygroup.com) ou visitez [www.sunjoyonline.com](http://www.sunjoyonline.com) pour de l'information ou de l'aide supplémentaire.

**¿Preguntas, problemas o piezas faltantes?**

Antes de regresar el producto a la tienda, Para asistencia técnica o preguntas, llame Sunjoy Group al 1(866) 578-6569 (inglés) (Teléfono no válido en México) a cualquier hora, o mande un correo electrónico a [customer.care@sunjoygroup.com](mailto:customer.care@sunjoygroup.com) o visite [www.sunjoyonline.com](http://www.sunjoyonline.com) para más información o asistencia.

**WARNING:**

- Check to ensure all parts are present prior to assembly.
- **This unit is heavy! At least 4 adults are needed for safe assembly. Never assemble this unit alone!**
- Keep all children and pets away from assembly area. Children and pets should be supervised when they are in the area of the gazebo construction.
- Keep assembly area more than 1.8 m / 5.9 ft from any obstruction such as a fence, garage, house, overhanging branches, laundry line or electrical wires.
- Some parts may contain sharp edges. When assembling and using this product, basic safety precautions should always be followed to reduce the risk of personal injury and damage to the product. Please read all instructions before assembly and use.
- For outdoor use only. Check all bolts for tightness before use and periodically check and tighten bolts as necessary.
- Assemble this unit on firm, level ground or hard surface only. Ensure the unit is level after final assembly.
- Do not assemble the gazebo on sandy, muddy or loose soil, as stakes (not included) do not have enough anchorage in these types of soil.
- If you wish to secure the gazebo to a wood deck or concrete surface, use anchors suited to these surfaces.
- Remove all excess snow from the roof.
- In order to avoid damage, use a plastic snow rake to remove excessive snow and ice buildup from roof and keep away from falling debris.
- Do not leave the gazebo where there is a risk of high wind, as possible damage will occur to the structure.
- Any assembly or maintenance of the product must be carried out by adults only.
- Protect parts during assembly by laying them on a non-abrasive surface such as blankets or cardboard.

**CARE INSTRUCTIONS:**

- Steel components for this gazebo are treated with rust inhibiting paint that protects it from rusting. However, due to the nature of steel, surface oxidation (rusting) will occur if these protective coatings are scratched. This is not a defect and thus not covered by the warranty.
- To minimize this condition, it is recommended to use care when assembling and handling the product to prevent scratching the paint. Should any scratching or damage occur, it is recommended to cover the scratch immediately with rust inhibiting paint (not included).
- Surface rust can also be easily removed with a very light application of regular cooking oil or WD-40. If surface oxidation (rusting) occurs and if no measure is taken to prevent this, the oxidation may start dripping onto deck or patio and caused damaging stains, which may be difficult to remove. This can be prevented if the above-mentioned measures are taken to keep the product from oxidizing.
- Do not use bleach, acid, or other abrasive cleaners on the roof or frame parts.
- Keep instruction manual for future reference.
- Periodically check and ensure that all bolts are well-tighten during use.

**TWO-YEAR LIMITED WARRANTY**

This limited warranty is extended to the original purchaser and applies to defects in material and workmanship of your item provided the item is maintained with care and used only for personal, residential purposes. The manufacturer warrants this item is free of defects in material and workmanship for a period of two years. If any defect is found, please call our customer service department at 1-866-578-6569 or email at [customer.care@sunjoygroup.com](mailto:customer.care@sunjoygroup.com) for help. The manufacturer will not cover transportation or delivery costs or compensate the individual or any outside party for assembling or disassembling the product.

## **AVERTISSEMENT:**

- Vérifier qu'il ne manque aucune pièce avant de commencer le montage.
- **Ce pavillon est lourd! Au moins quatre adultes sont nécessaires à un montage sécuritaire. Ne jamais monter le pavillon seul!**
- Tenir les enfants et les animaux à l'écart ou les surveiller pendant le montage.
- Assembler le pavillon à plus de 1,8 m (5,9 pi) de tout obstacle tel qu'une clôture, un garage, une maison, des branches d'arbres, une corde à linge ou des fils électriques.
- Certaines pièces ont des bords tranchants. Au moment du montage et durant l'utilisation de ce produit, toujours prendre des mesures de sécurité élémentaires pour réduire les risques de blessure ou de dommage au pavillon. Lire toutes les instructions avant de monter et d'utiliser le pavillon.
- Pour usage extérieur seulement. Vérifier la solidité des vis et des boulons avant la première utilisation, et de façon régulière par la suite; les resserrer au besoin.
- Monter ce pavillon sur une surface dure ou sur un sol plan et ferme seulement. Vérifier que le produit est de niveau après le montage.
- N'assemblez pas le gazébo sur des surfaces de sable, de boue ou de terre molle car les piquets (pas comprises) n'ont pas assez d'ancrage pour ces sortes de surfaces.
- Si vous souhaitez fixer le gazébo sur une terrasse en bois ou une surface en béton, utilisez des ancrs adaptés à ces surfaces.
- Retirez tout excès de neige du toit.
- Pour éviter les dommages, utilisez un râteau en plastique pour enlever l'excès de neige et de glace du toit et éviter les chutes de débris.
- Ne laissez pas le gazébo dans un endroit avec un risque de vent fort, pour éviter les dommages à la structure.
- Tout montage ou entretien du produit doit être uniquement effectué par des adultes.
- Pendant le montage, protéger les pièces en les disposant sur une surface non abrasive comme une couverture ou du carton.

## **ENTRETIEN:**

- Les composants en acier de ce gazébo sont traités avec une peinture antirouille qui le protège de la rouille. Cependant, dû à la nature de l'acier, l'oxydation de la surface (rouille) peut se produire si ces couches protectrices sont rayées. Ce n'est pas un défaut et donc n'est pas couvert par la garantie.
- Pour réduire cette condition, il est recommandé de faire très attention lors du montage et de la manipulation du produit pour éviter de rayer la peinture. En cas de rayures ou de dommages, il est recommandé de couvrir immédiatement les rayures avec une peinture antirouille (pas comprise).
- La rouille sur la surface peut également être facilement éliminée avec une application très légère d'huile de cuisson ordinaire ou de WD-40. S'il se produit de l'oxydation (rouille) sur la surface et si on ne prend aucune mesure pour l'empêcher, l'oxydation peut commencer à couler sur la terrasse ou le patio et causer des taches nuisibles, qui peuvent être difficiles à enlever. Ceci peut s'éviter si l'on prend les mesures mentionnées ci-dessus pour empêcher que le produit se rouille.
- N'utilisez pas de javel, d'acides, ou d'autres nettoyeurs abrasives sur le toit ou sur les pièces de la structure.
- Gardez le manuel d'instructions pour le consulter dans l'avenir.
- Vérifiez périodiquement pour vous assurer que tous les boulons sont serrés fortement pendant l'emploi.

## **GARANTIE LIMITÉE DE DEUX ANS**

Cette garantie limitée ne s'applique qu'à l'acheteur original et aux défauts en matériel et en main d'oeuvre de votre produit, à condition que l'article a été maintenu avec soin et utilisé uniquement pour emploi personnel et résidentiel. Le fabricant garanti que cet article n'a aucun défaut matériel et de main d'oeuvre pendant une période de deux ans. Si vous trouvez un défaut, veuillez appeler le département de service au client au numéro 1-866-578-6569 ou par courriel à [customer.care@sunjoygroup.com](mailto:customer.care@sunjoygroup.com) pour de l'aide. Le fabricant ne paiera pas les frais de transport et de manutention et ne dédommagera pas l'acheteur ni aucun tiers pour l'assemblage ou le démontage de l'article.

## **ADVERTENCIA:**

- Antes de comenzar a ensamblar este producto, asegúrese que todas las piezas estén completas.
- **¡Esta unidad es pesada! Se requieren 4 adultos para ensamblar de manera segura.**  
**¡Nunca ensamble este producto usted solo!**
- Mantenga alejados a los niños y mascotas del área de ensamblado. Se debe supervisar en todo momento a los niños y las mascotas cuando se encuentren cerca del área de construcción de la cochera.
- Mantenga alejada el área de ensamblado a una distancia de al menos 1,8 m de cualquier obstrucción, como puede ser una cerca, garaje y casa, ramas colgantes, ropa o cables eléctricos.
- Algunas piezas pueden tener bordes afilados. Cuando utilice este producto siempre debe de seguir precauciones básicas de seguridad para reducir el riesgo de lesiones personales y daños al producto. Lea todas la instrucciones antes de ensamblar y utilizar este producto.
- Únicamente para uso en exteriores. Antes de usar revise que los tornillos estén bien apretados, compruebe periódicamente y vuelva a apretar según sea necesario.
- Ensamble esta unidad únicamente en una superficie firme o rígida a nivel de piso. Asegúrese de que la unidad esté bien nivelada después del montaje final.
- No Instale el gazebo sobre una superficie arenosa, barrosa o suelta, porque las estacas (no incluidas) no tendrán bastante anclaje para estos tipos de tierra.
- Si desea instalar el gazebo sobre una superficie de Madera o de cemento, utilice las anclas adecuadas para estas superficies.
- Retire el exceso de nieve del techo.
- Para evitar daños, utilice un rastrillo de plástico para desalojar el exceso de nieve y hielo sobre el techo y no permita que le puedan caer escombros.
- No deje el gazebo donde exista el riesgo de vientos fuertes, porque podría provocar daños a la estructura.
- Cualquier montaje o mantenimiento del producto deberá efectuarse por adultos únicamente.
- Proteja las piezas durante el ensamblado poniéndolas en una superficie no abrasiva como una manta o un cartón.

## **INSTRUCCIONES DE CUIDADO**









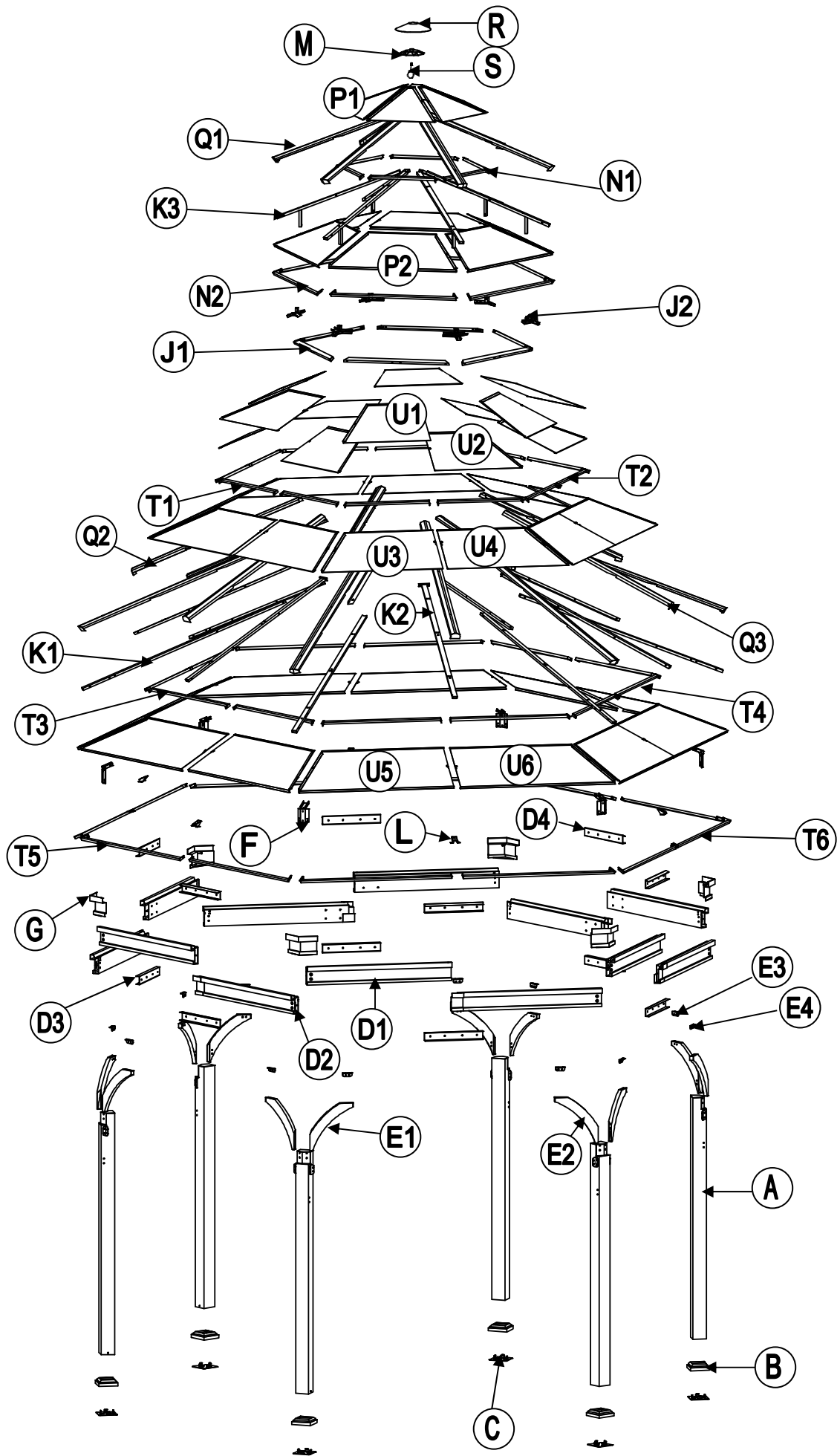

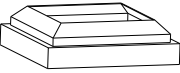
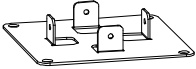

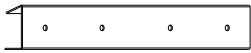

- Los componentes de acero de este gazebo están tratados con una pintura inhibidora del óxido que los protege contra el óxido. Sin embargo, debido a la naturaleza del acero, se podría producir óxido si estas capas se arañan. Esto no es un defecto y por esa razón no está cubierto por la garantía.
- Para minimizar esta condición, recomendamos tener cuidado mientras monta y manipula el producto para evitar arañar la pintura. Si se produce un arañazo o cualquier daño, recomendamos cubrir el arañazo inmediatamente con una pintura contra el óxido (no incluida).
- El óxido sobre la superficie se puede quitar también fácilmente con una aplicación ligera de aceite para cocinar o de WD-40. Si la superficie se oxida y no se toman las medidas adecuadas para evitarlo, el óxido empezará a gotear sobre la superficie o el patio y provocará manchas inconvenientes difíciles de eliminar. Esto se puede evitar si las medidas mencionadas arriba se toman para evitar que el producto se oxide.
- No utilice lejía, ácido o cualquier otro limpiador abrasivo sobre el techo o las piezas de la estructura.
- Guarde el manual de instrucciones para consultarlo en el porvenir.
- Verifique periódicamente para asegurarse que todos los tornillos están bien apretados antes de utilizar.





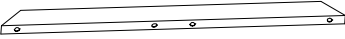
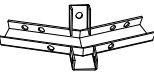





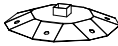



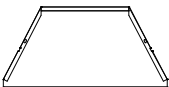

## **GARANTIA LIMITADA DE DOS AÑOS**





Esta garantía limitada se concede al comprador original y se aplica a defectos materiales y de mano de obra de su producto, siempre y cuando el artículo haya sido mantenido con cuidado y utilizado sólo para uso personal y residencial. El fabricante garantiza que este artículo no tiene ningún defecto material y de mano de obra durante un periodo de dos años. Si encuentra algún defecto, llame, por favor, a nuestro departamento de servicio al consumidor al 1-866-578-6569 o por correo electrónico a [customer.care@sunjoygroup.com](mailto:customer.care@sunjoygroup.com) para que le ayuden. El fabricante no cubre por los gastos de transporte o de entrega, ni compensa al individuo o cualquier otra persona por el montaje o desmontaje del producto.





Parts Diagram/ Schéma des pièces / Diagrama de las piezas

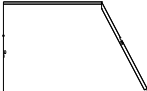

Parts List/Liste de Pièces/Listado de piezas			
Label Étiquette Etiqueta	Part Number No de pièce Parte	Qty QTÉ Cantidad	Part Image Diagramme de la pièce Diagrama de la Pieza
A	P00020086601	6	
B	P00610026801	6	
C	P00010026301	6	
D1	P00560041401	6	
D2	P00560041501	6	
D3	P00050213201	6	
D4	P00050213301	6	
E1	P00500085501	6	
E2	P00500085601	6	
E3	P00050213501	12	
E4	P00050207601	12	
F	P00050203801	6	
G	P00560056101	6	
J1	P00050213401	6	
J2	P00050207801	6	
K1	P00060294201	6	
K2	P00060294301	6	
K3	P00060294601	6	

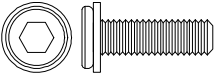
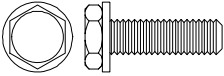
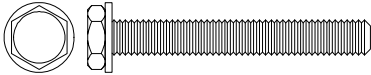
L	P00050213101	6	
M	P00050207901	1	
N1	P00060294401	6	
N2	P00060294501	6	
P1	P00070141501	6	
P2	P00070141601	6	
Q1	P00080050001	6	
Q2	P00080050101	6	
Q3	P00080050201	6	
R	P00090020601	1	
S	P00580015401	1	
T1	P00060294701	6	
T2	P00060294801	6	
T3	P00060294901	6	
T4	P00060295001	6	
T5	P00060295101	6	
T6	P00060295201	6	
U1	P00070141701	6	

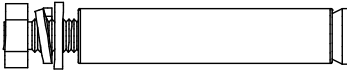
U2	P00070141801	6	
U3	P00070141901	6	
U4	P00070142001	6	
U5	P00070142101	6	
U6	P00070142201	6	

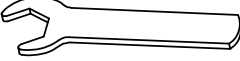
Hardware Pack/ Quincaillerie pour l'étape/ Paquete de herramienta					
Label Étiquette Etiqueta	Part Number No de pièce Parte	Description Description Descripción	Qty QTÉ Cantidad	Spare De rechange Repuestos	Part Image Diagramme de la pièce Diagrama de la Pieza
H1	H100010050	Bolt M6*20 Boulon M6*20 Tornillo M6*20	24	2	
H2	H100010047	Bolt M6*20 Boulon M6*20 Tornillo M6*20	498	25	
H3	H100010059	Bolt M6*45 Boulon M6*45 Tornillo M6*45	30	2	
HH	H050050018	M6 Flat Washer M6 Rondelle Plate M6 Arandela Plana	30	2	
HS	H010100002	Expansion Bolt Φ6*80 Boulons d'expansion Φ6*80 Tornillos de expansion Φ6*80	12	0	
HW1	H090030002	Allen Key M6 Clé M8 Llave Inglesa M8	1	0	
HW2	H090010017	Wrench M6 Clé M6 Llave Inglesa M6	2	0	

# 1

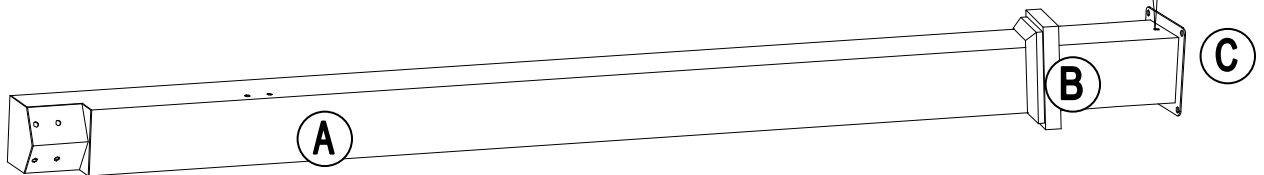
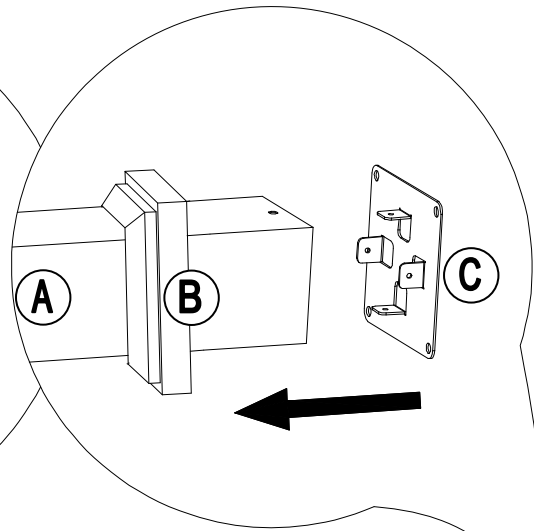
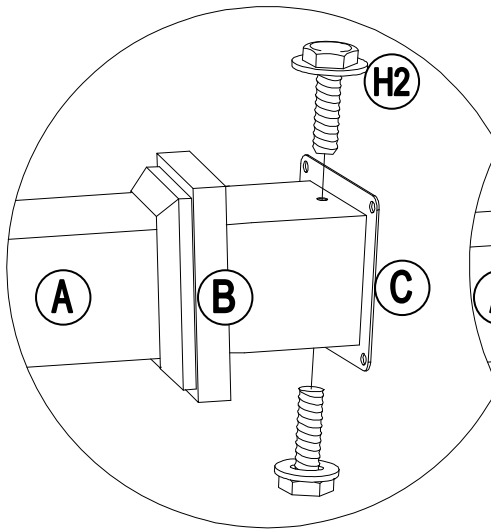
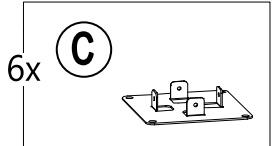
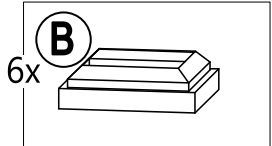
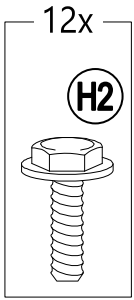
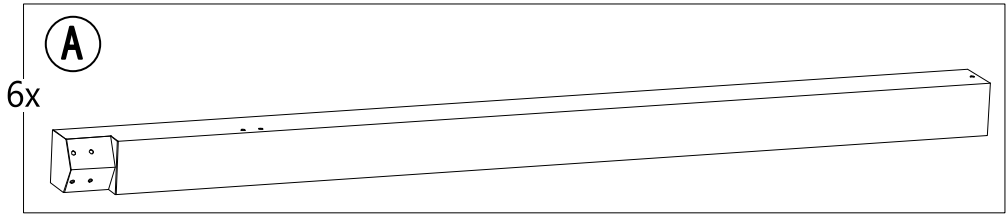

# 2

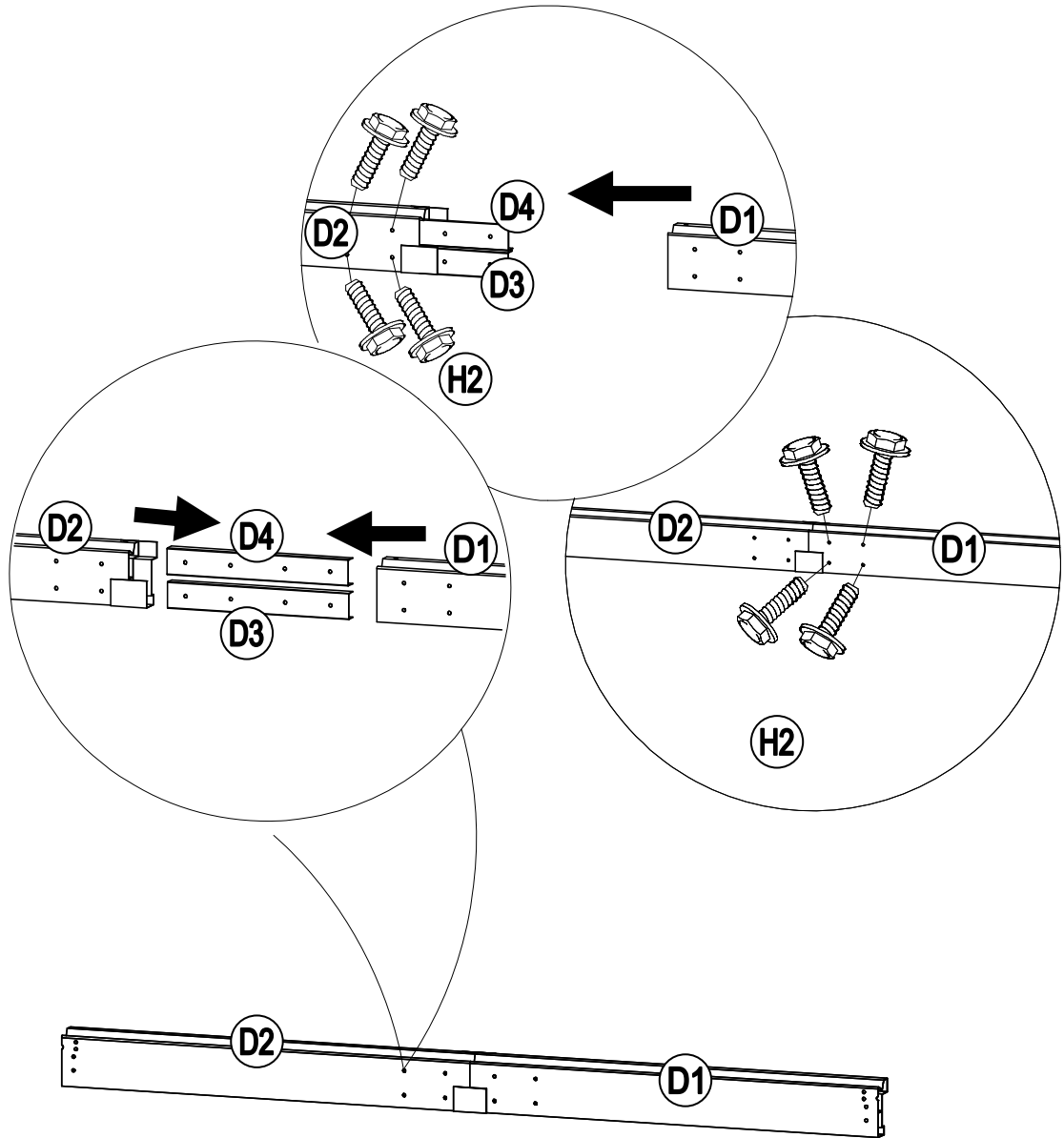
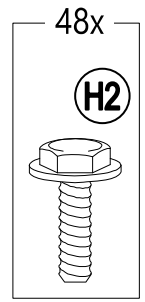
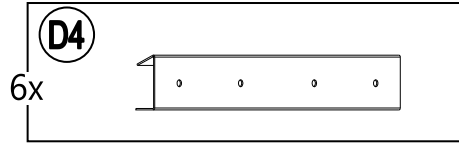
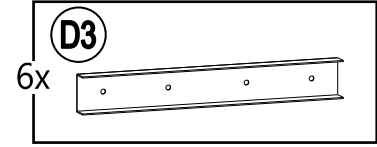
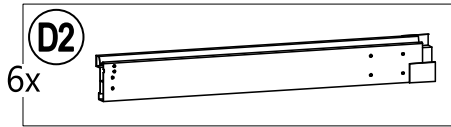
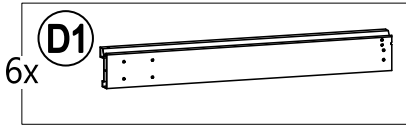

3

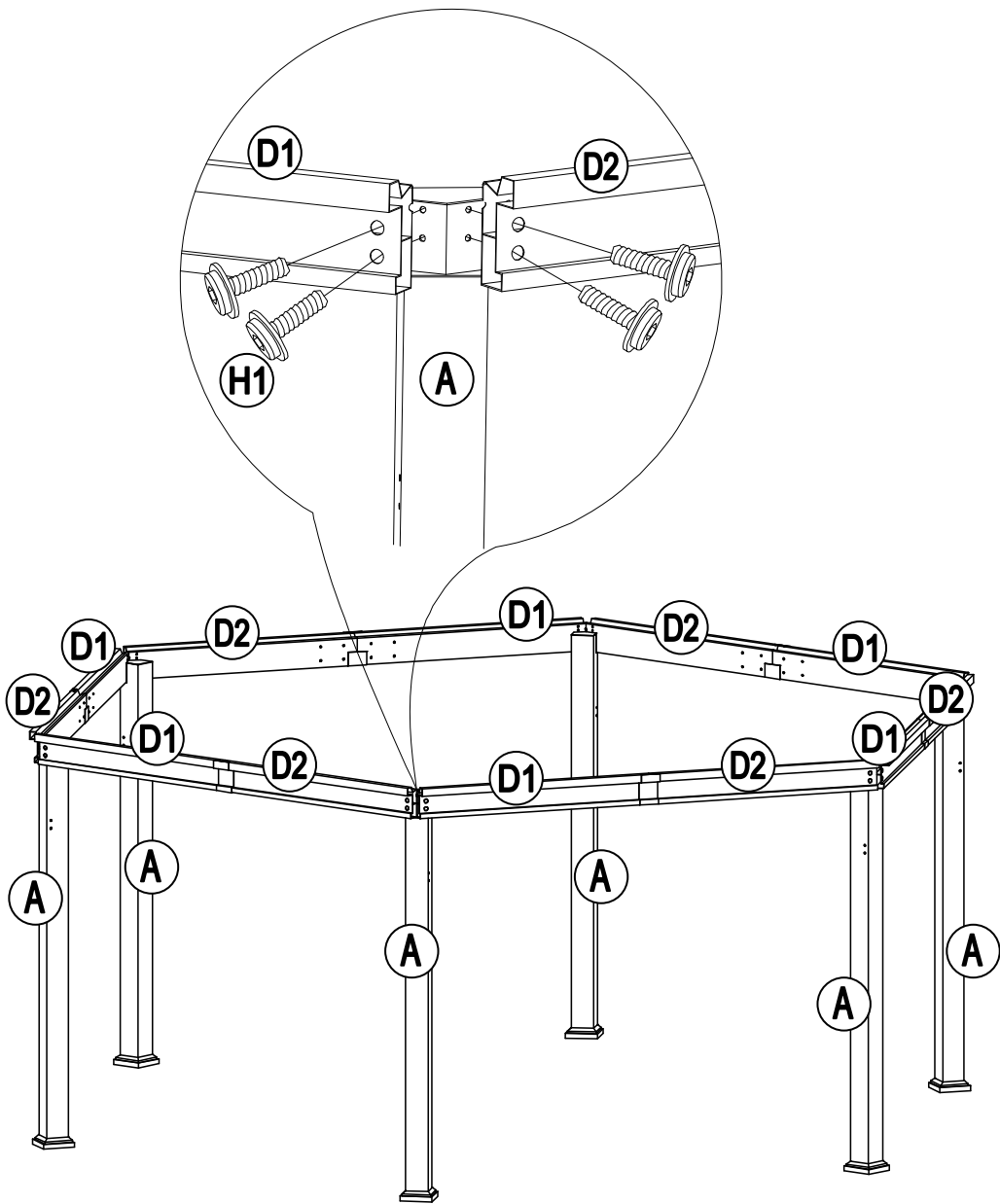
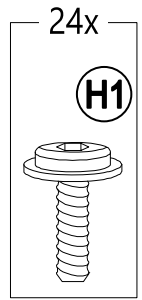
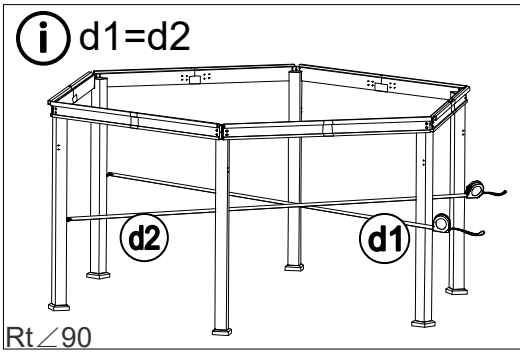

# 4

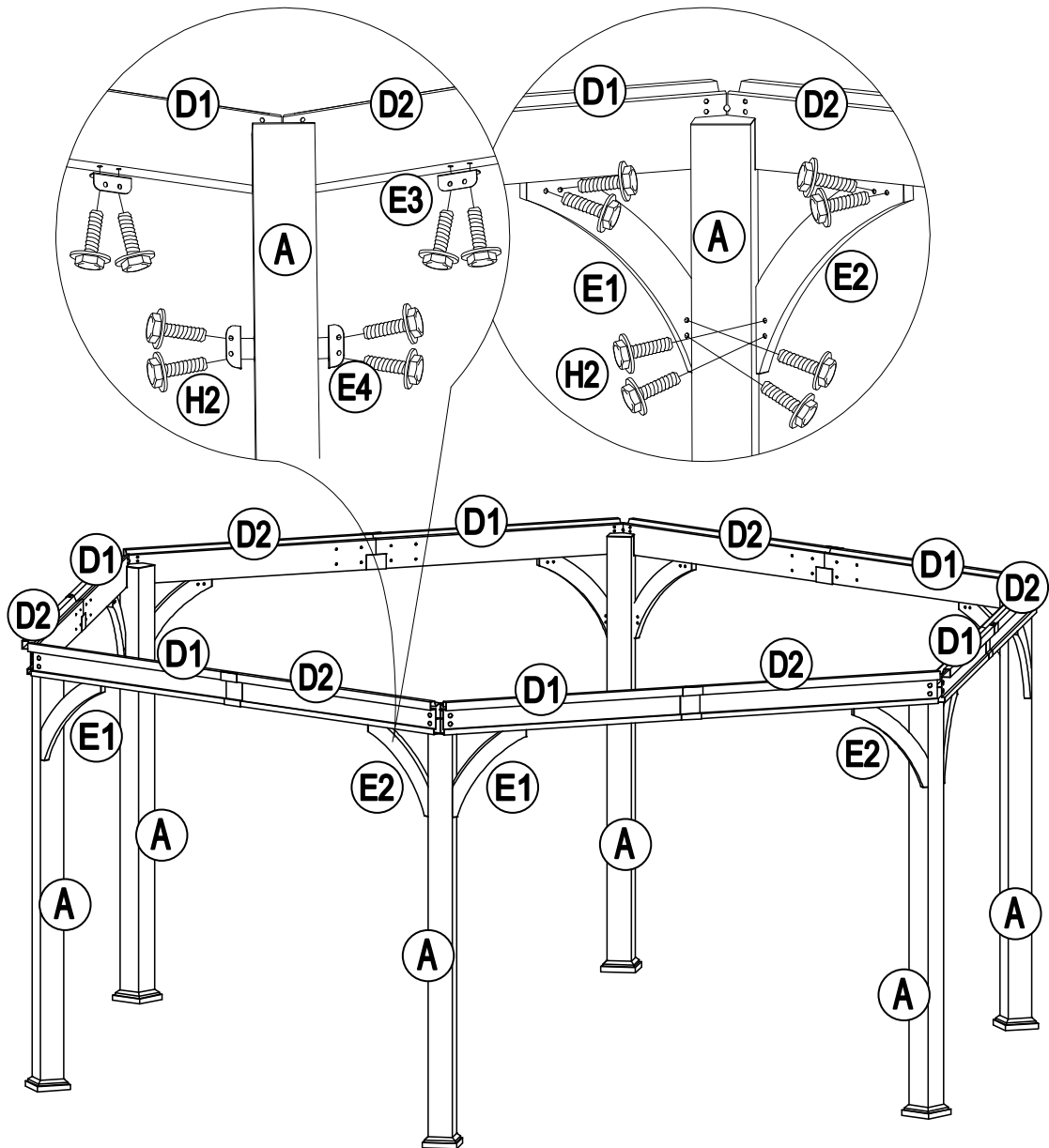
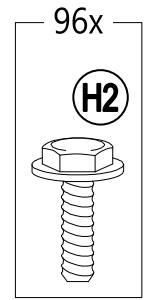
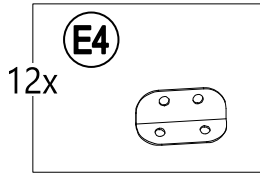
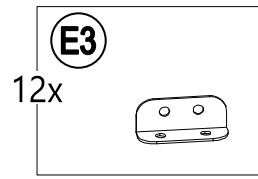
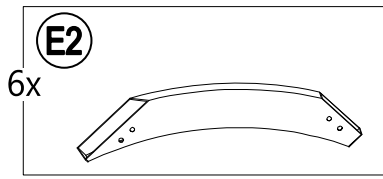
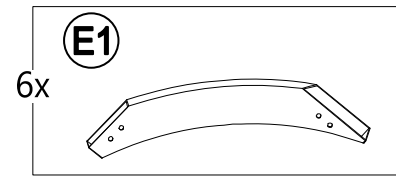

# 5

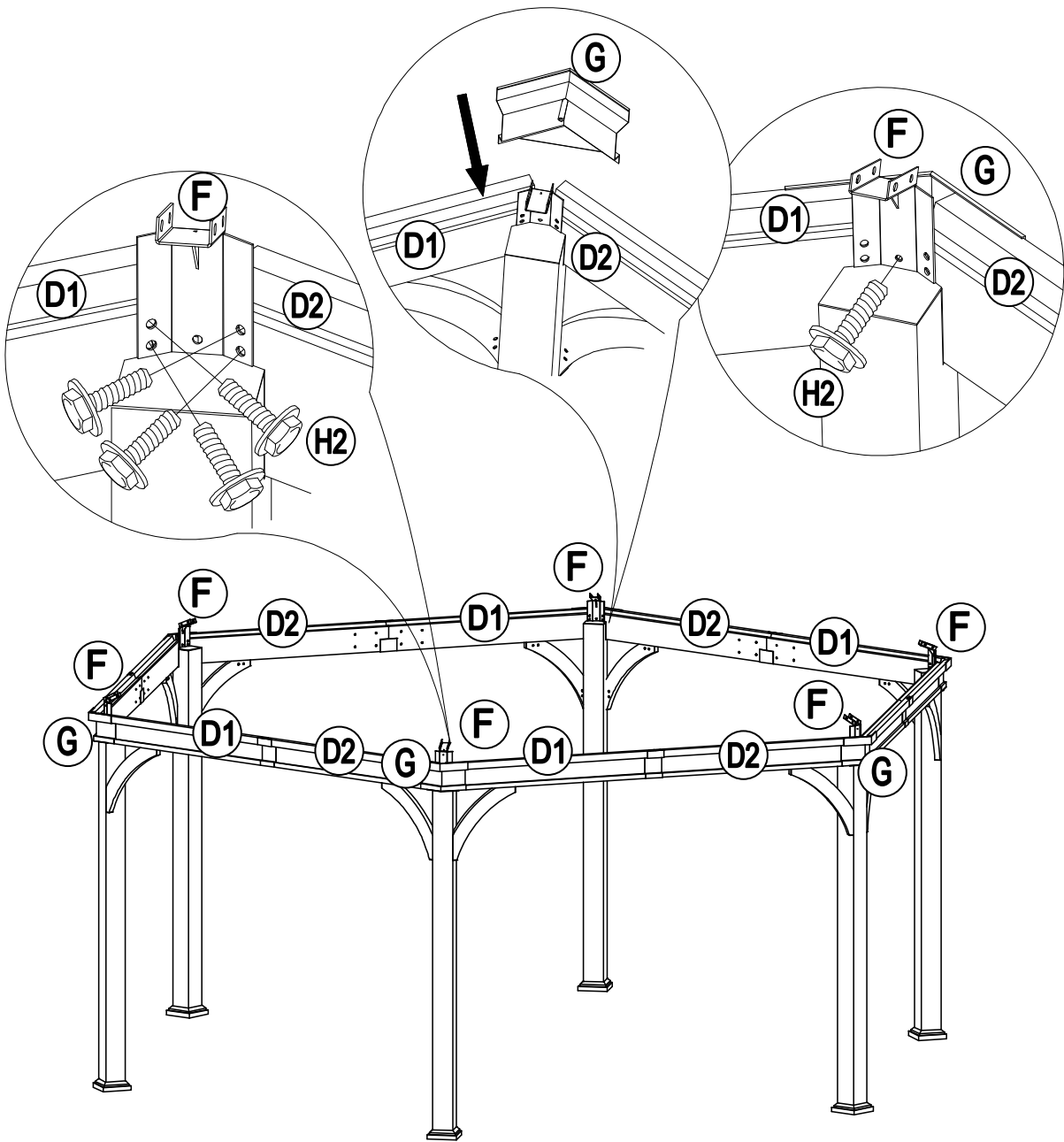
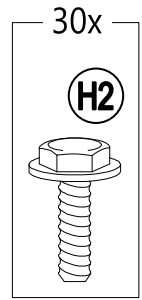
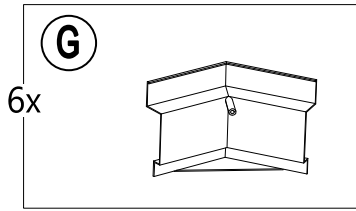
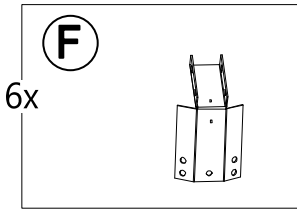

# 6

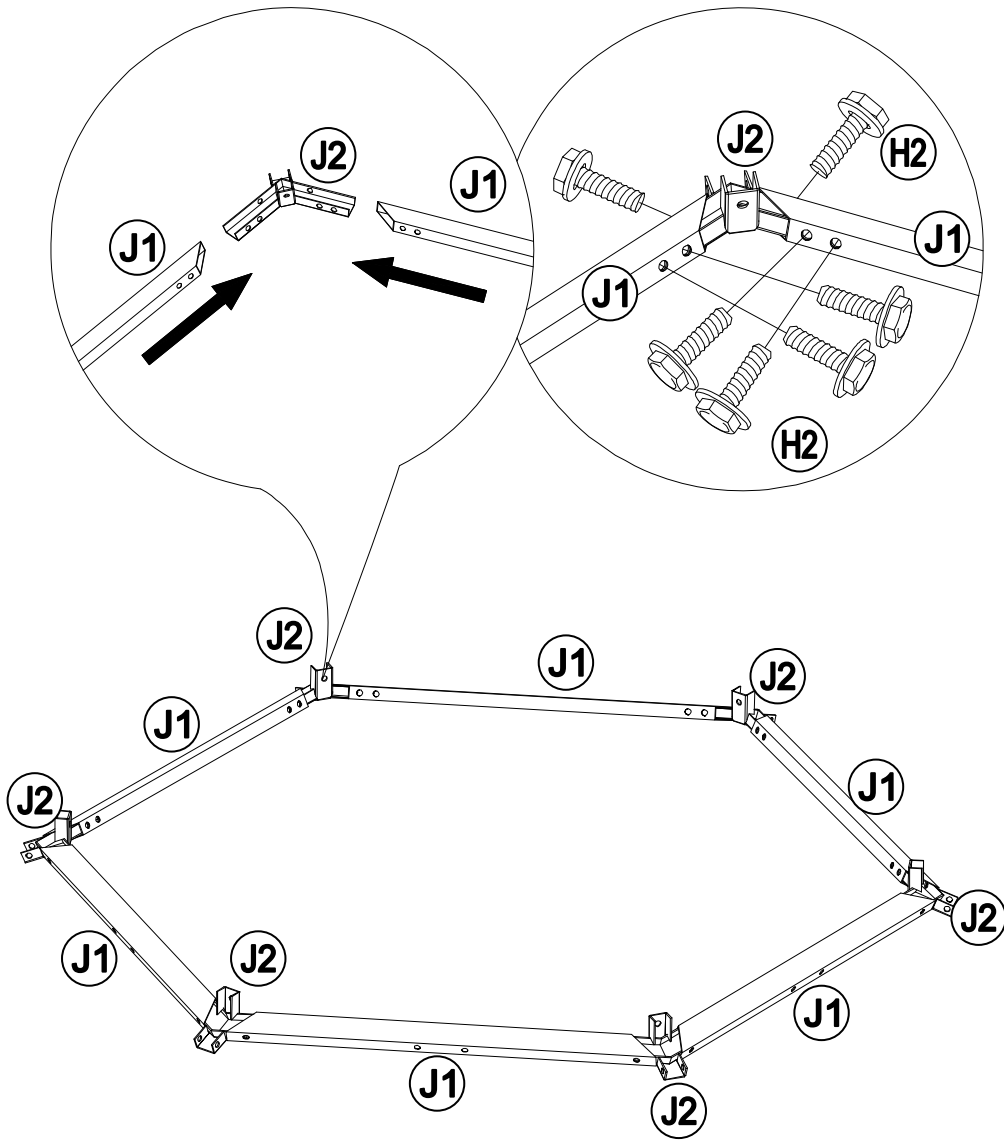
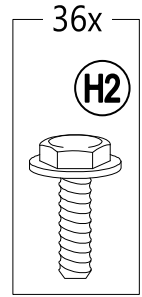
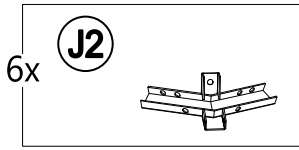
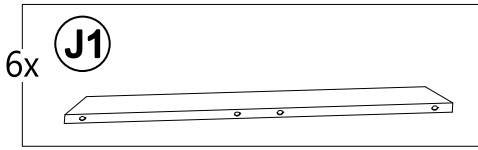



# 8

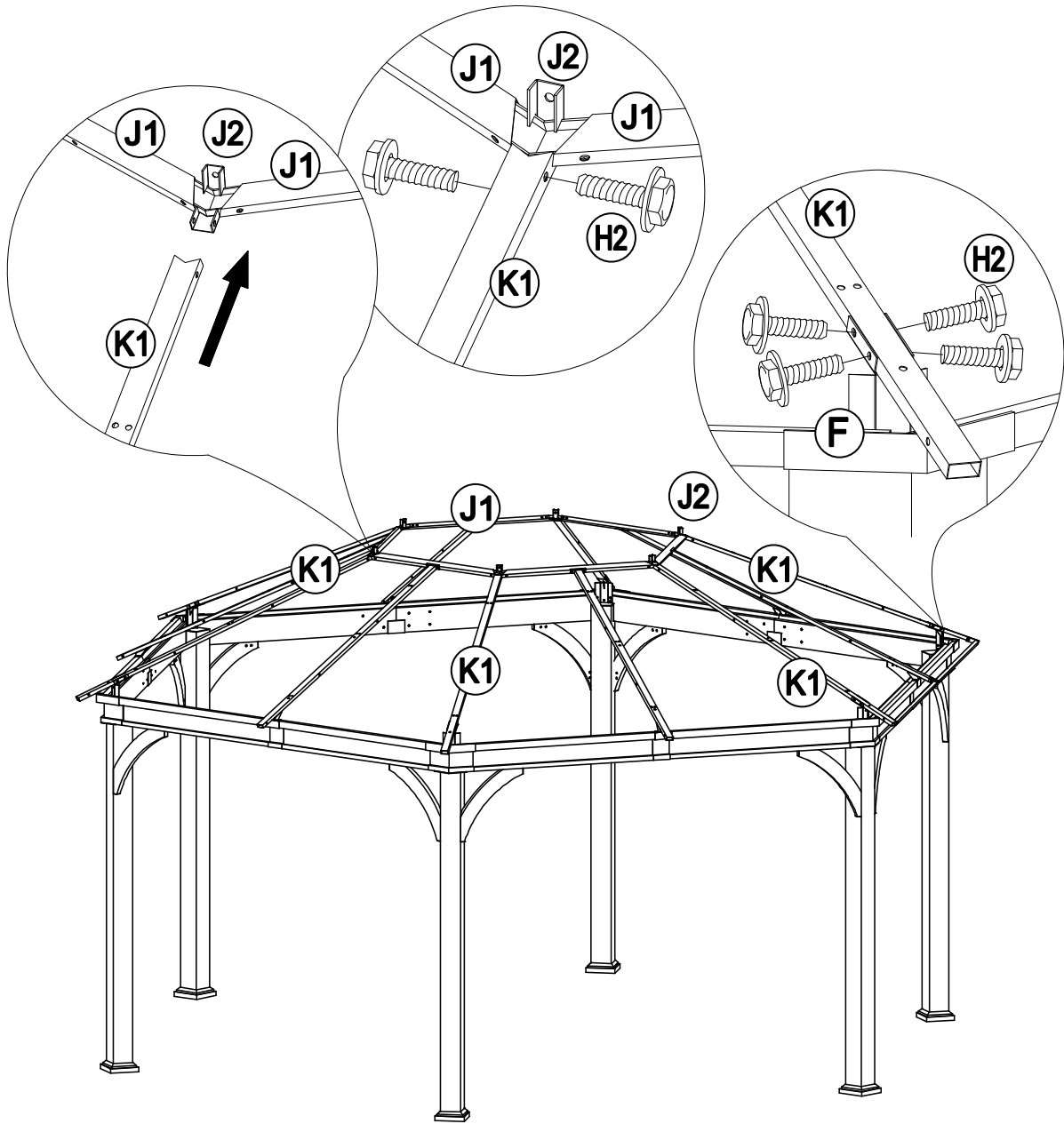
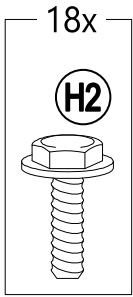
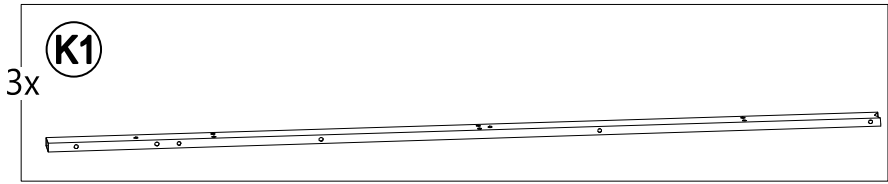

# 9

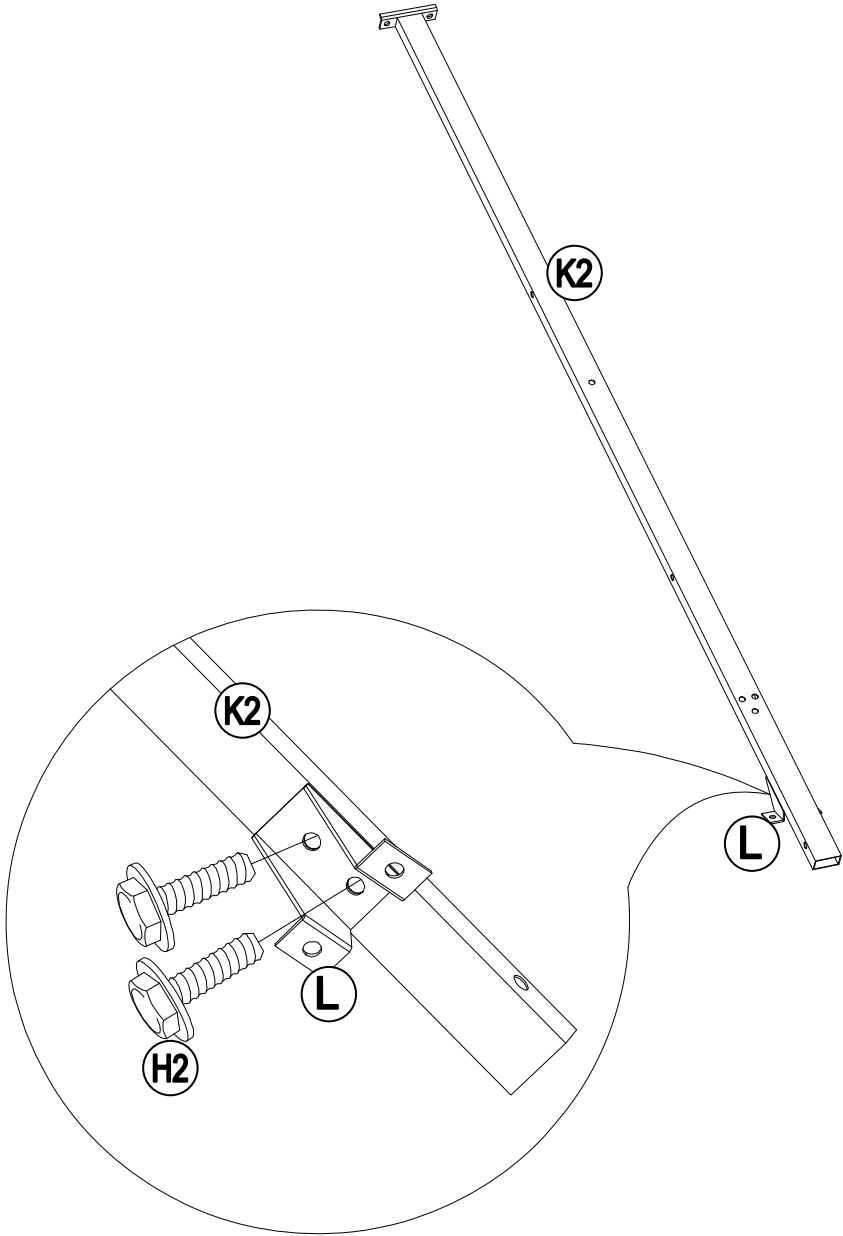
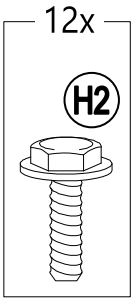
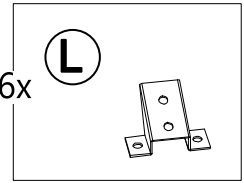
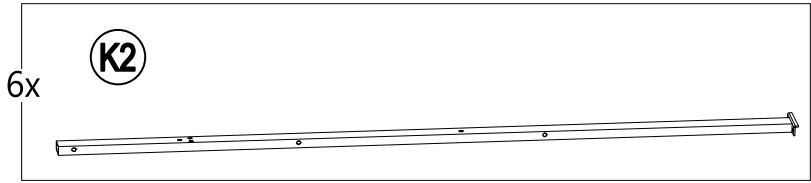

10

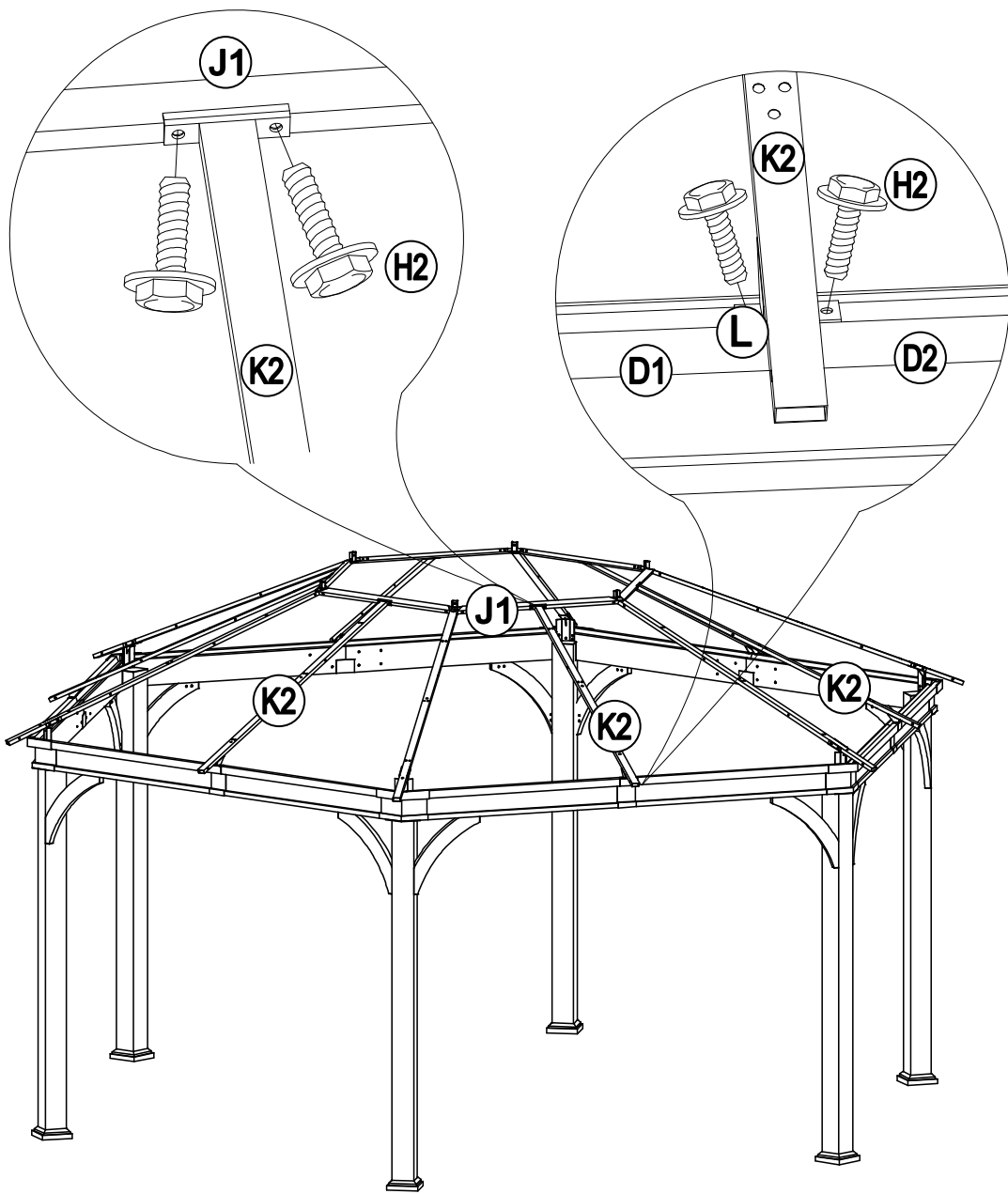
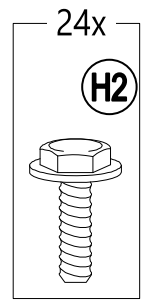

# 11

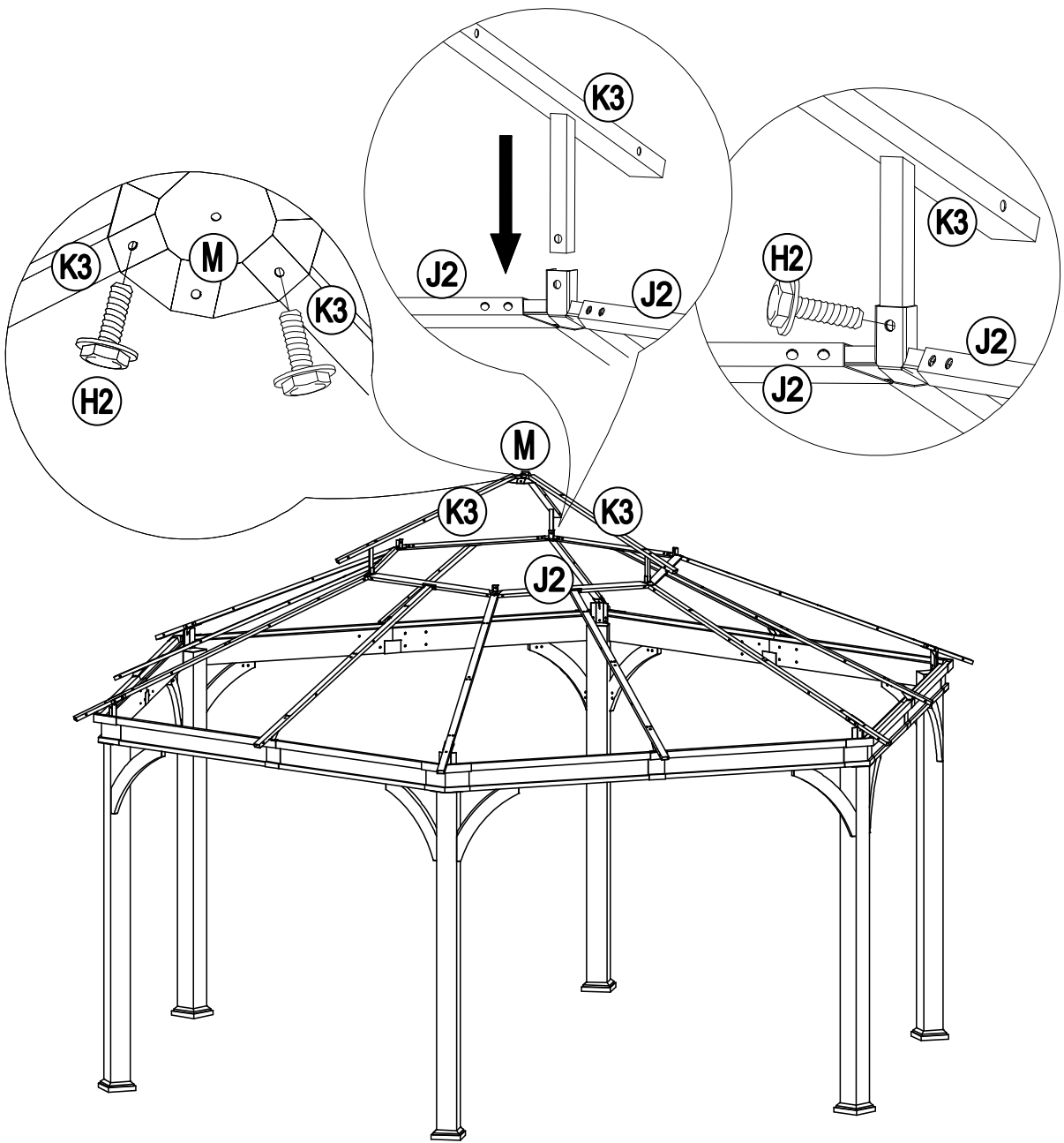
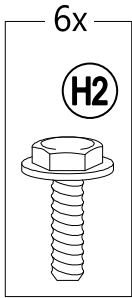
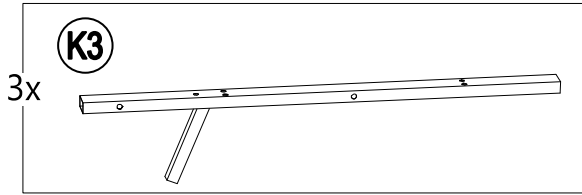
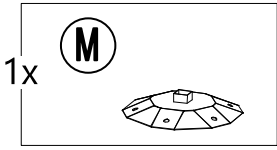

# 12

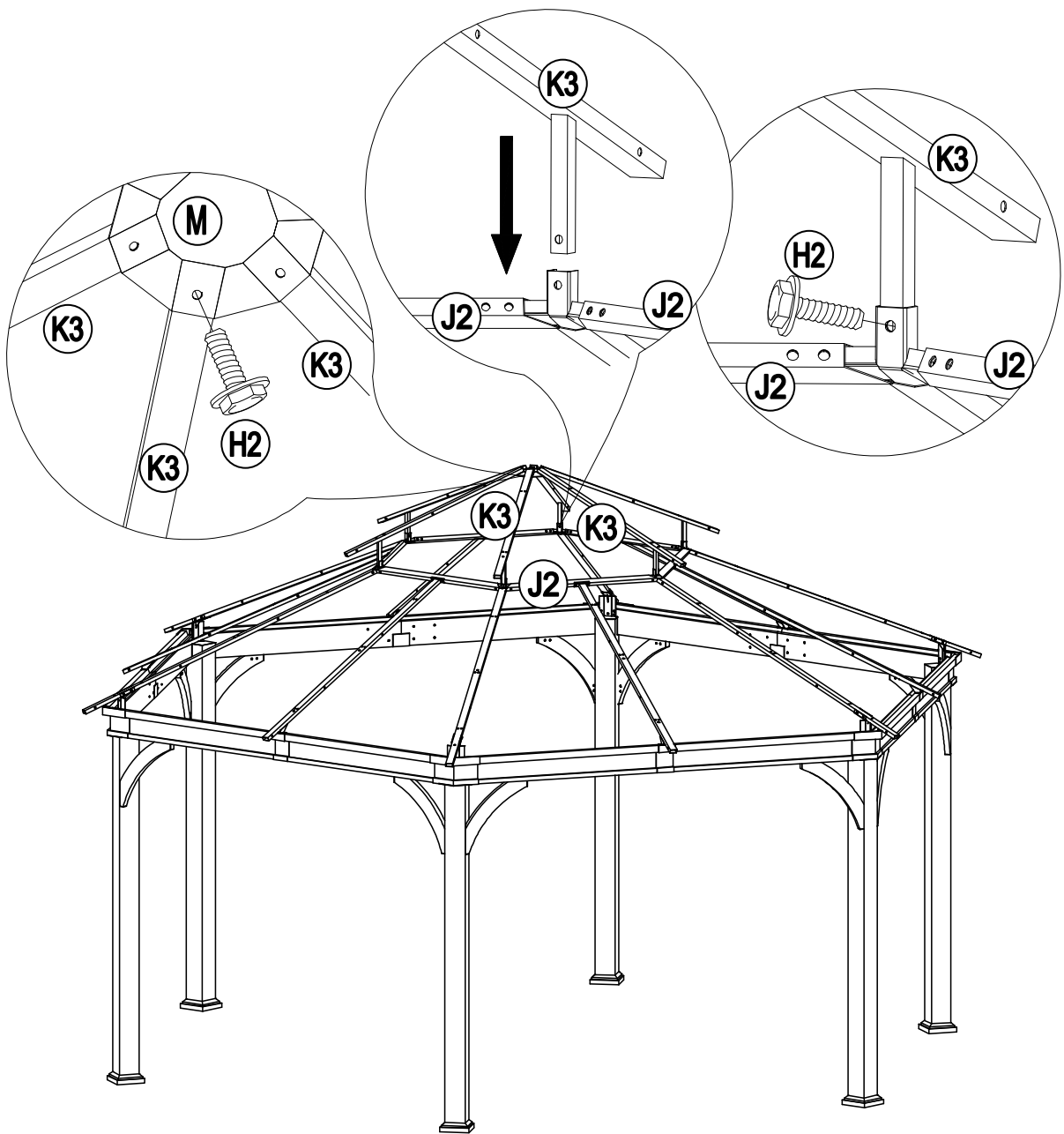
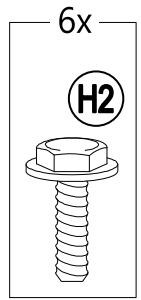
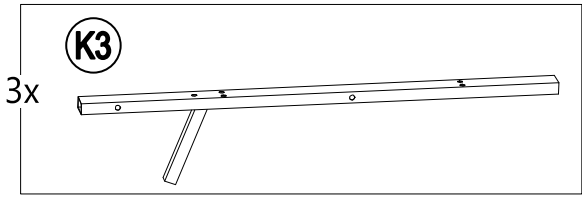

# 13

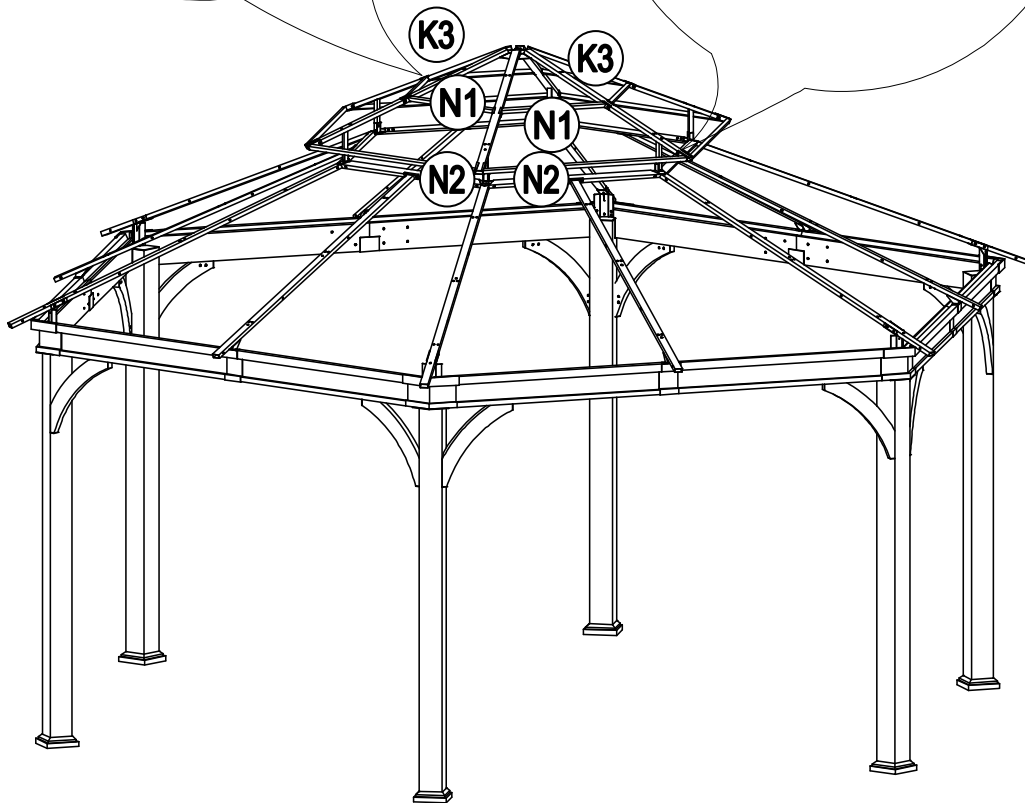
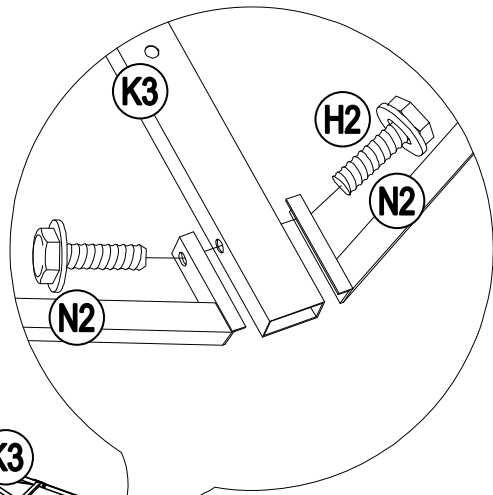
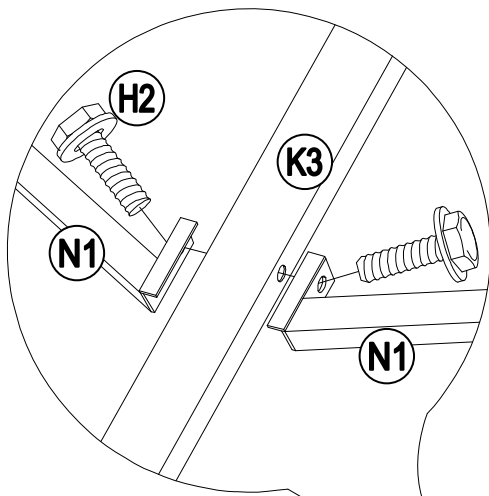
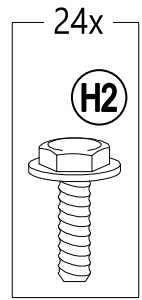
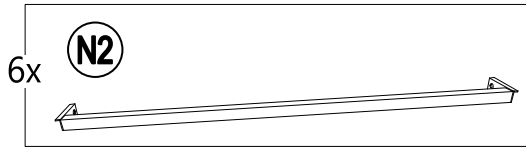
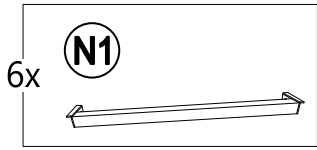

# 14

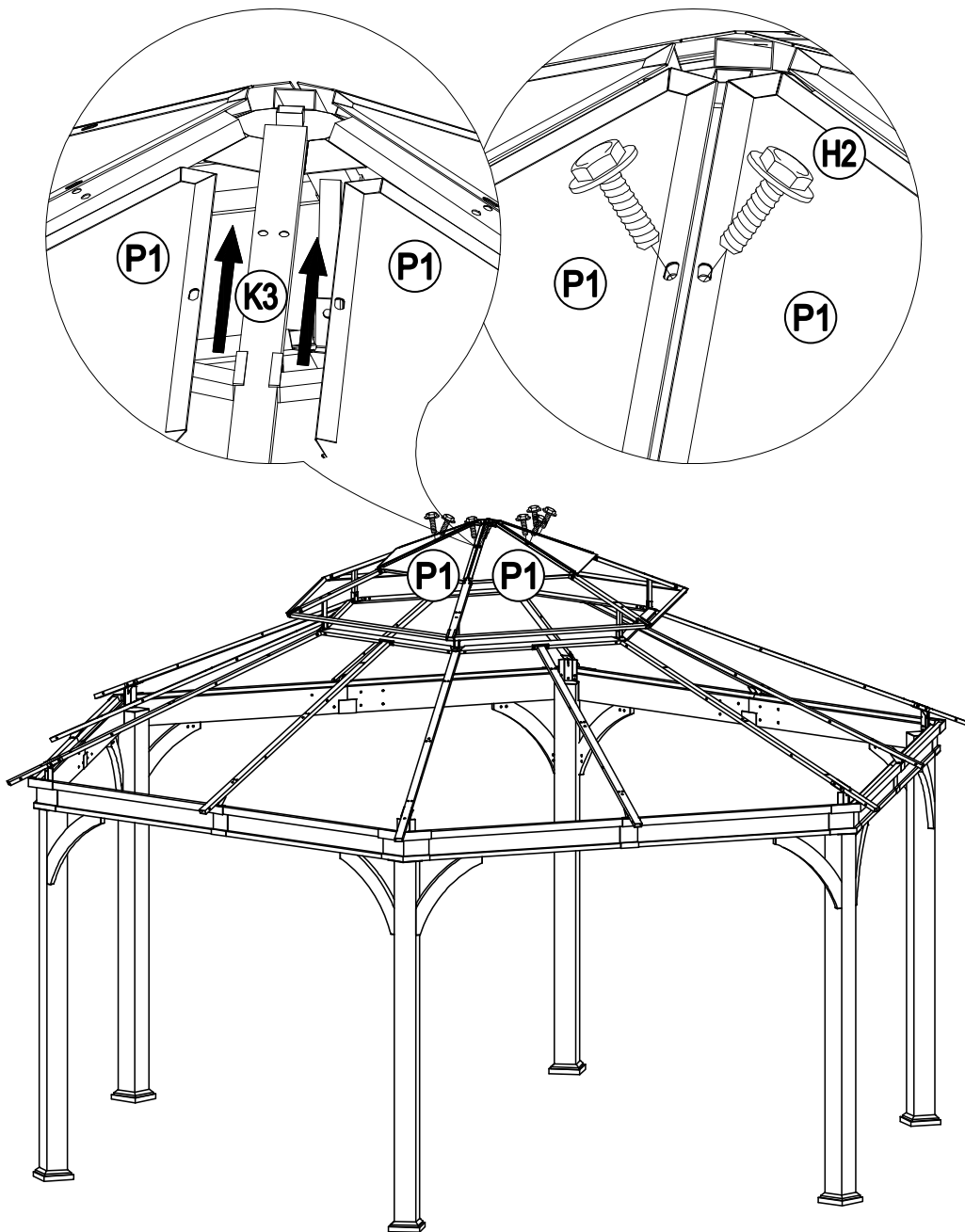
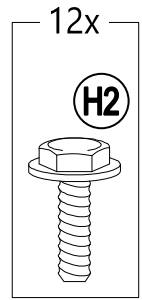
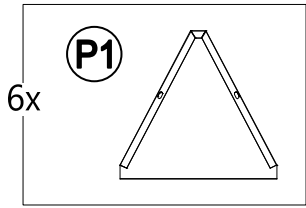

# 15

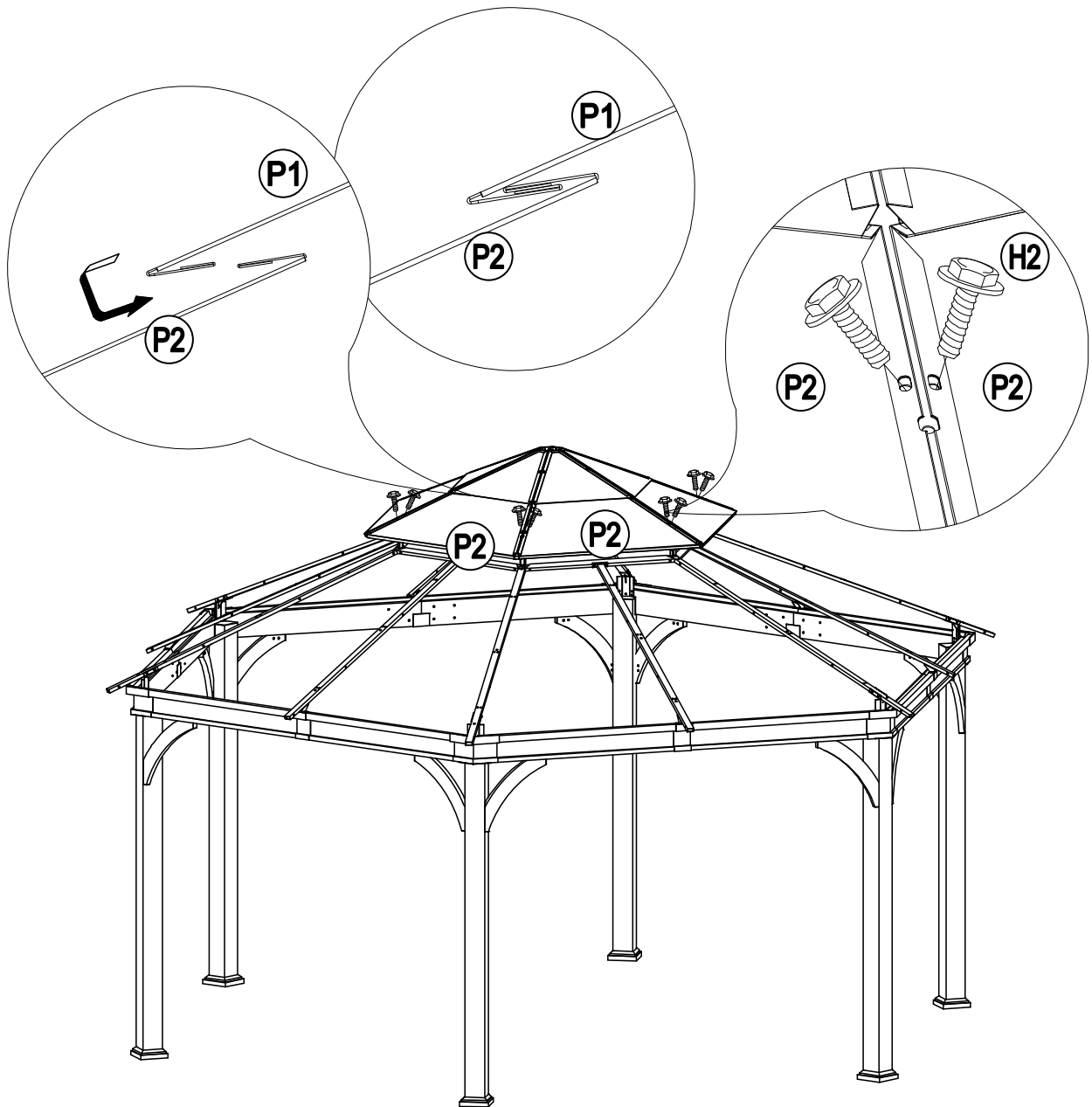
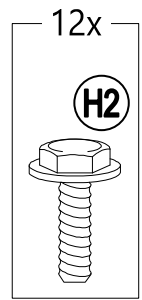
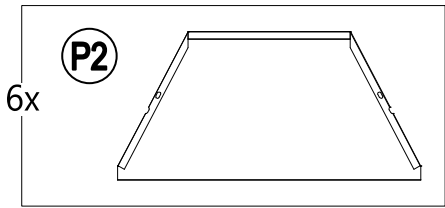

# 16

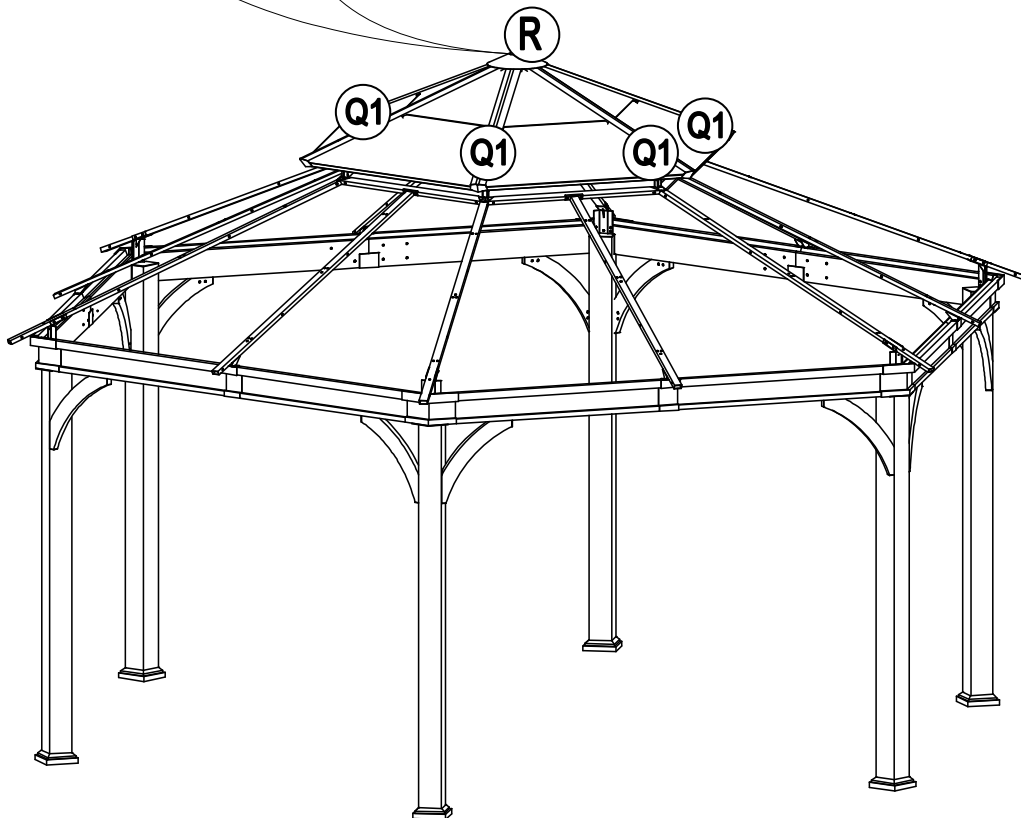
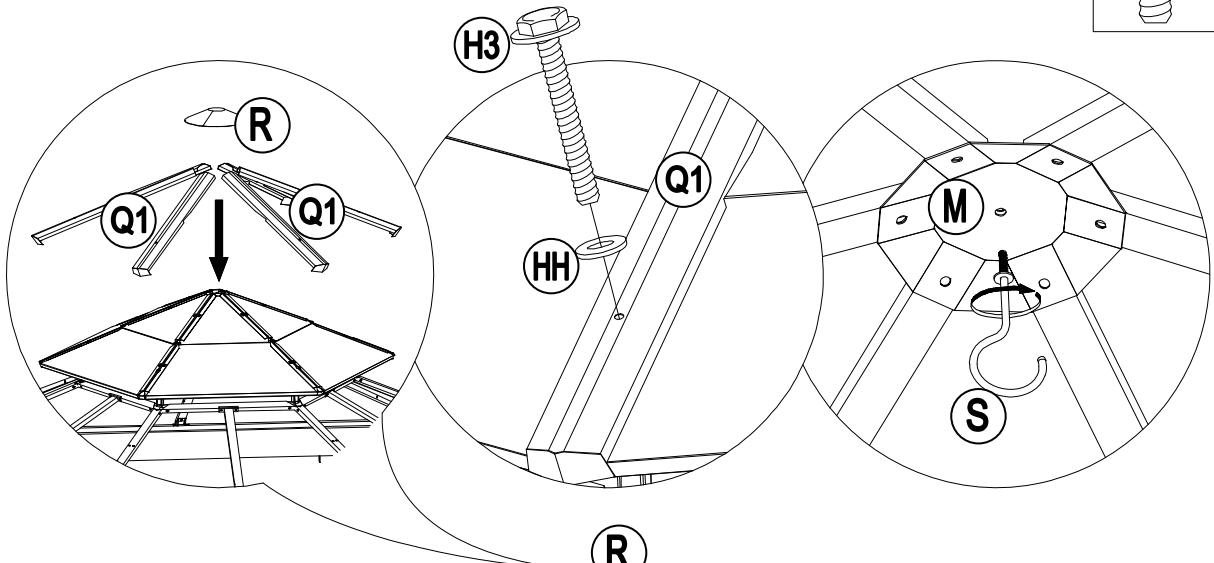
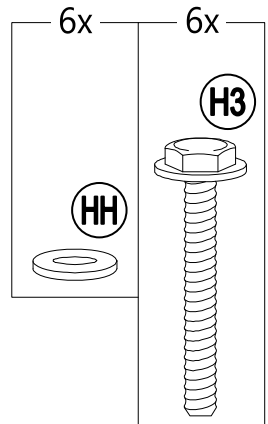
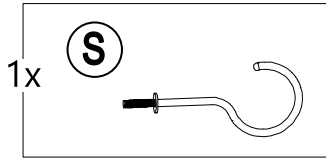
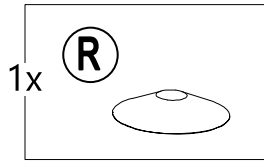
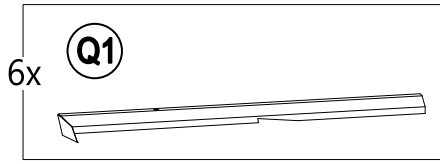

# 17

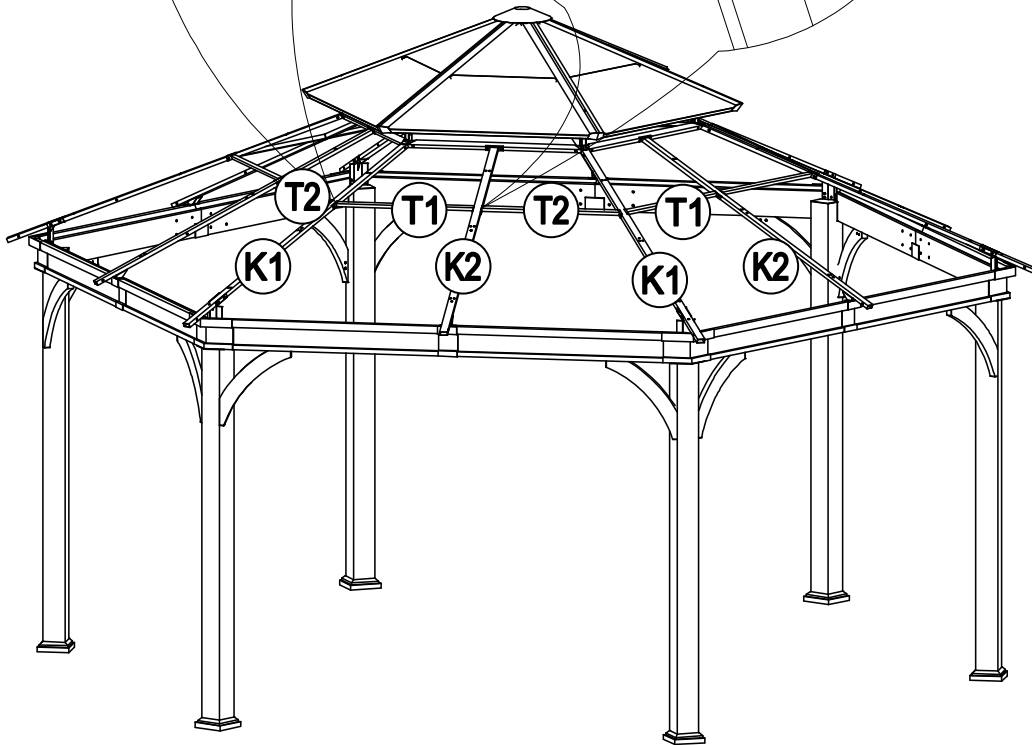
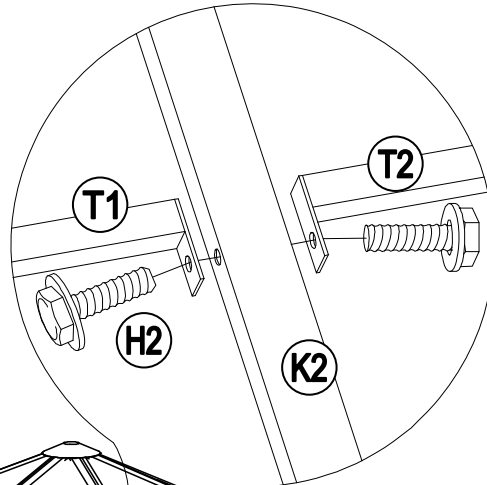
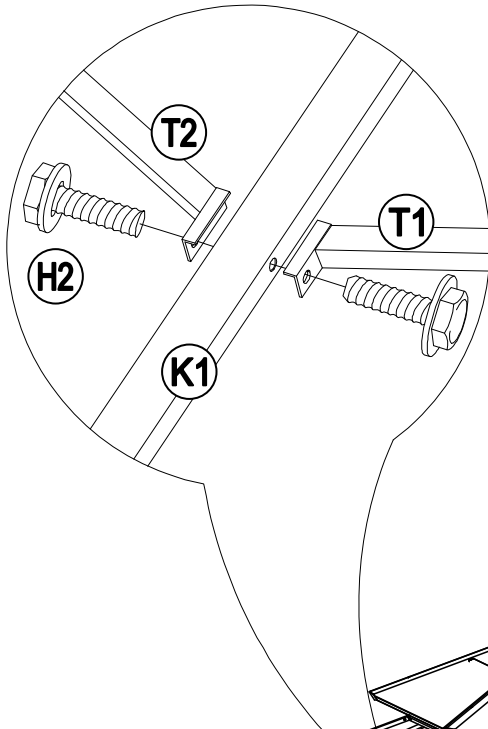
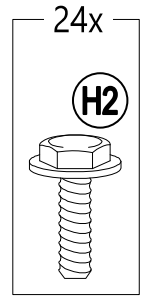
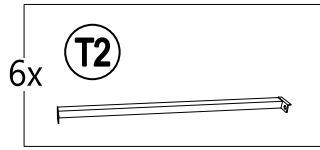
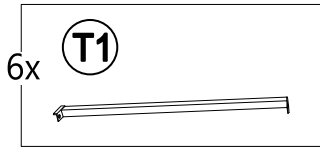

# 18

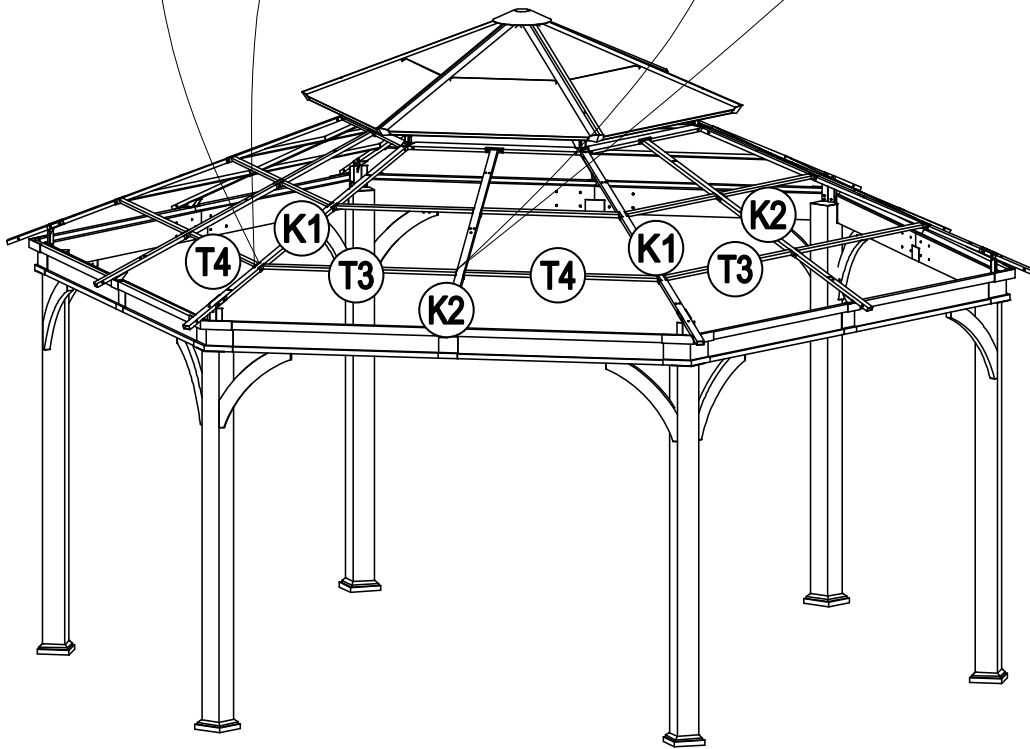
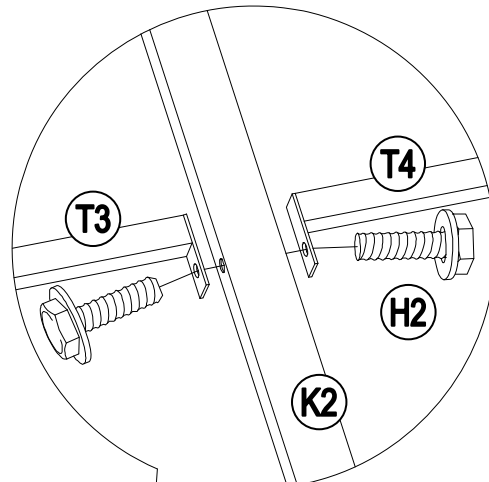
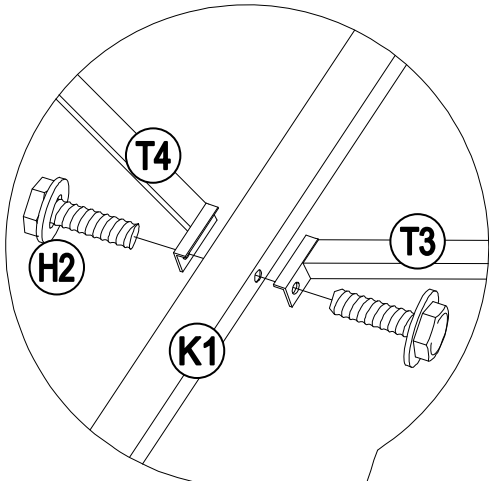
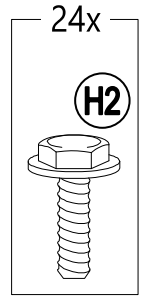
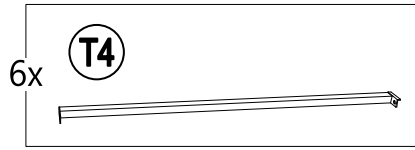
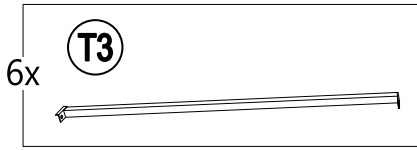

# 19

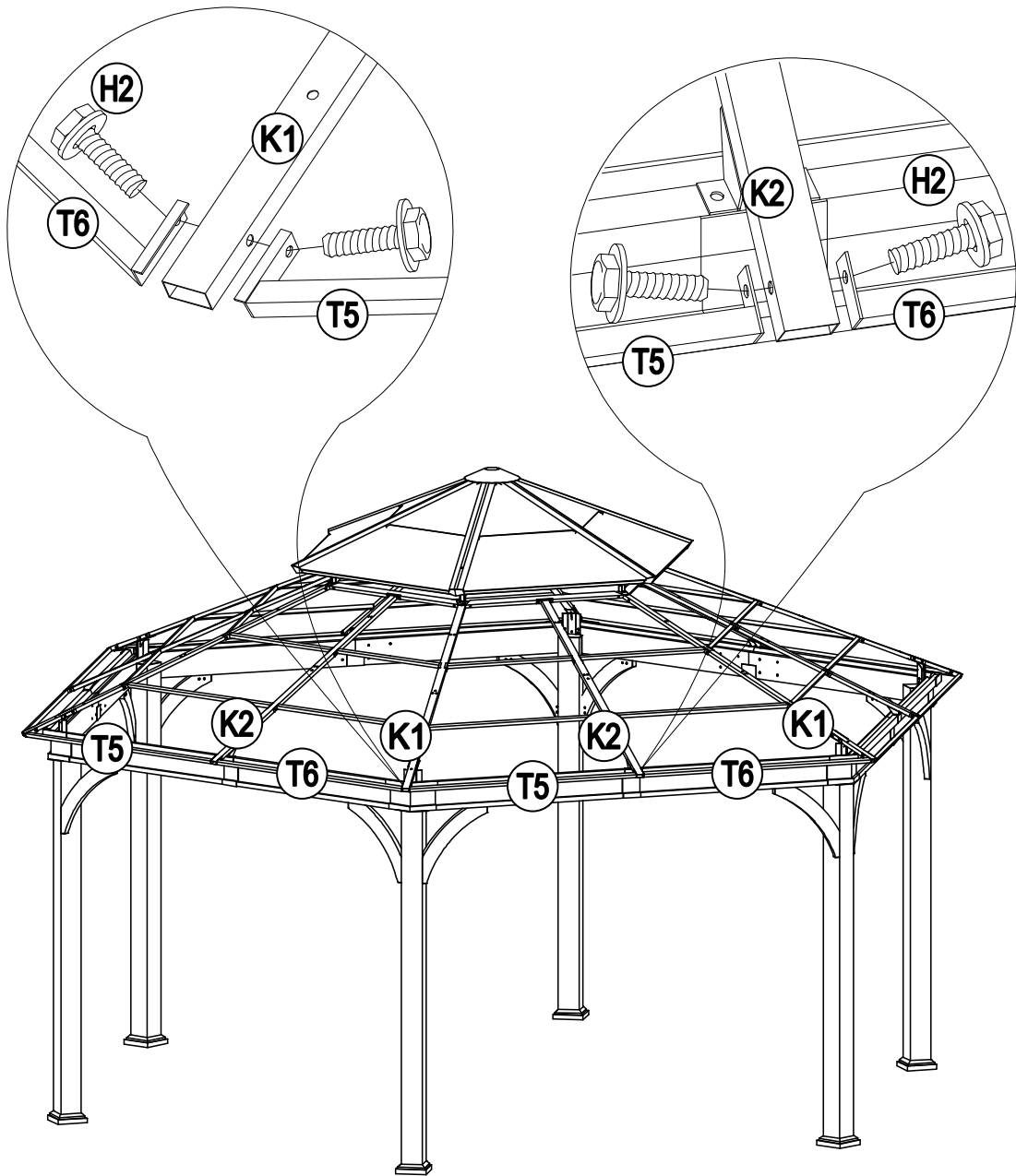
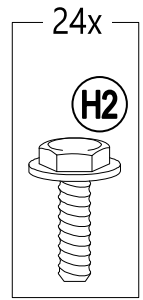
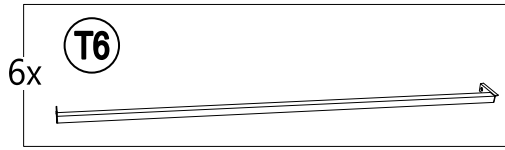
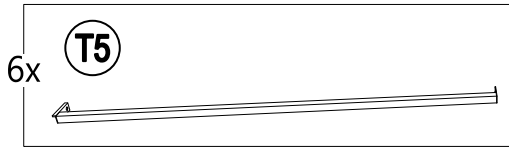

20

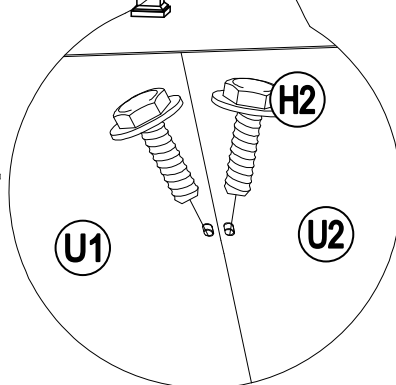
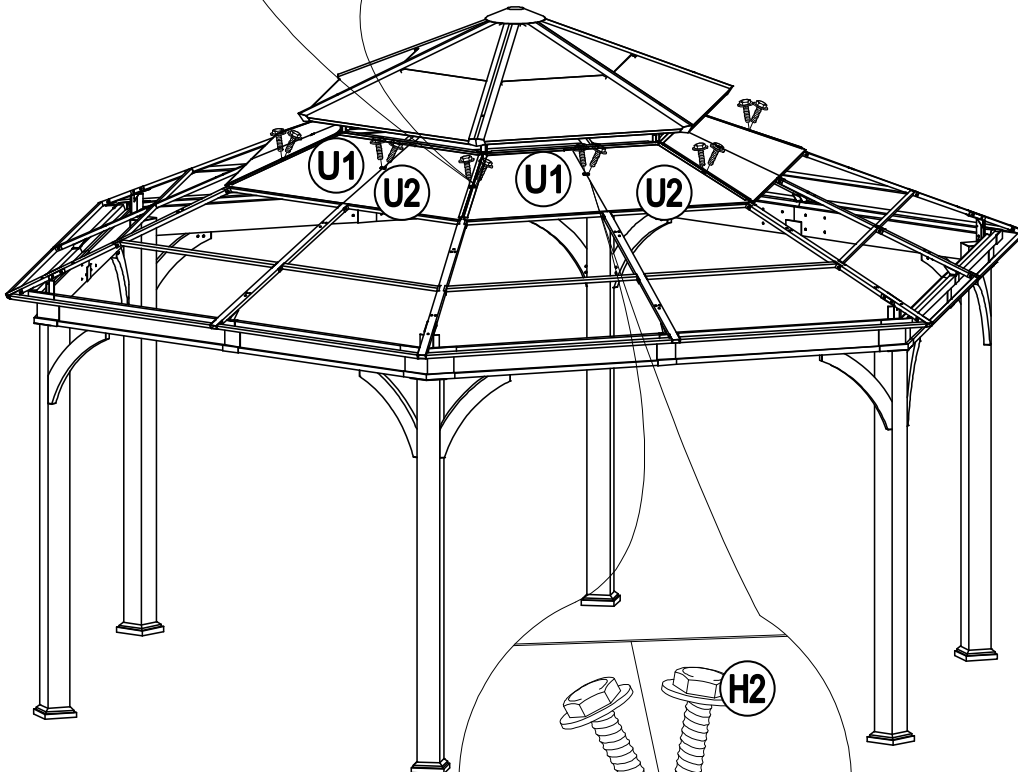
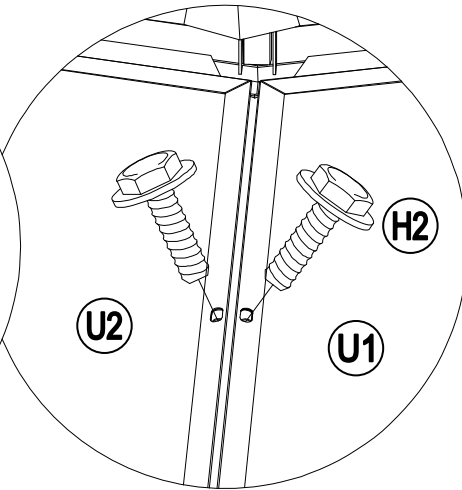
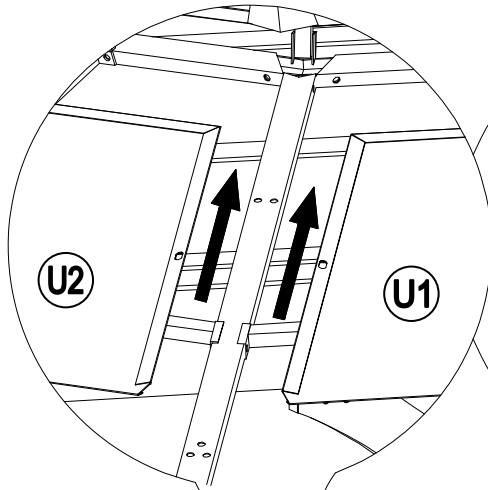
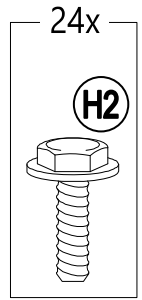
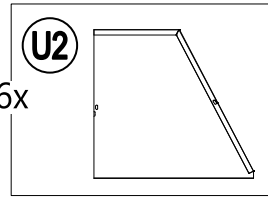
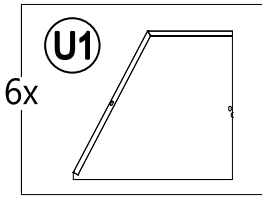

# 21

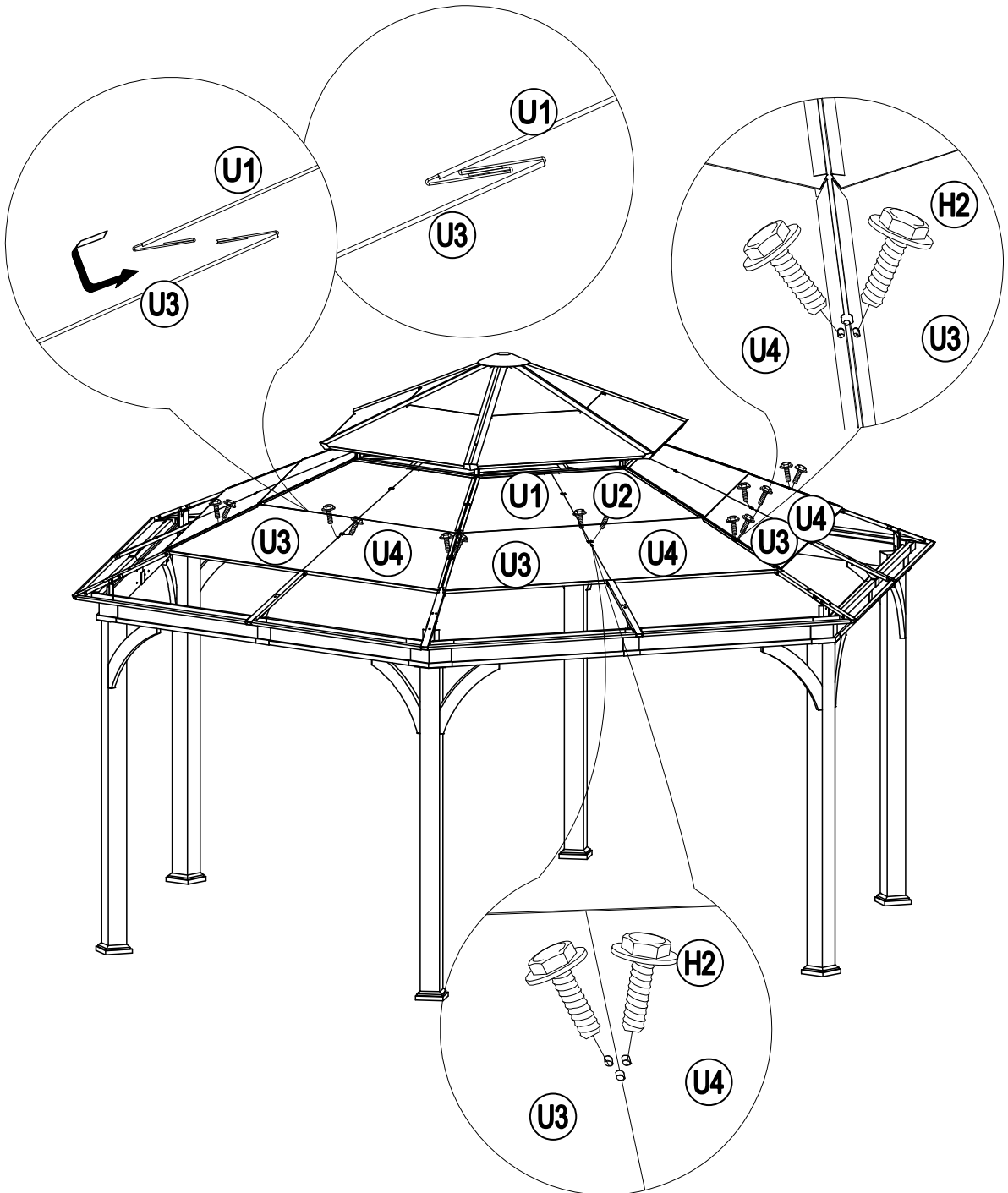
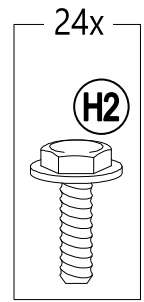
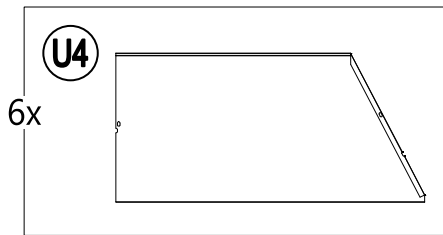
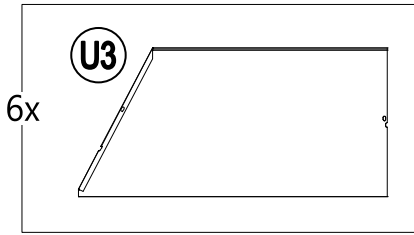

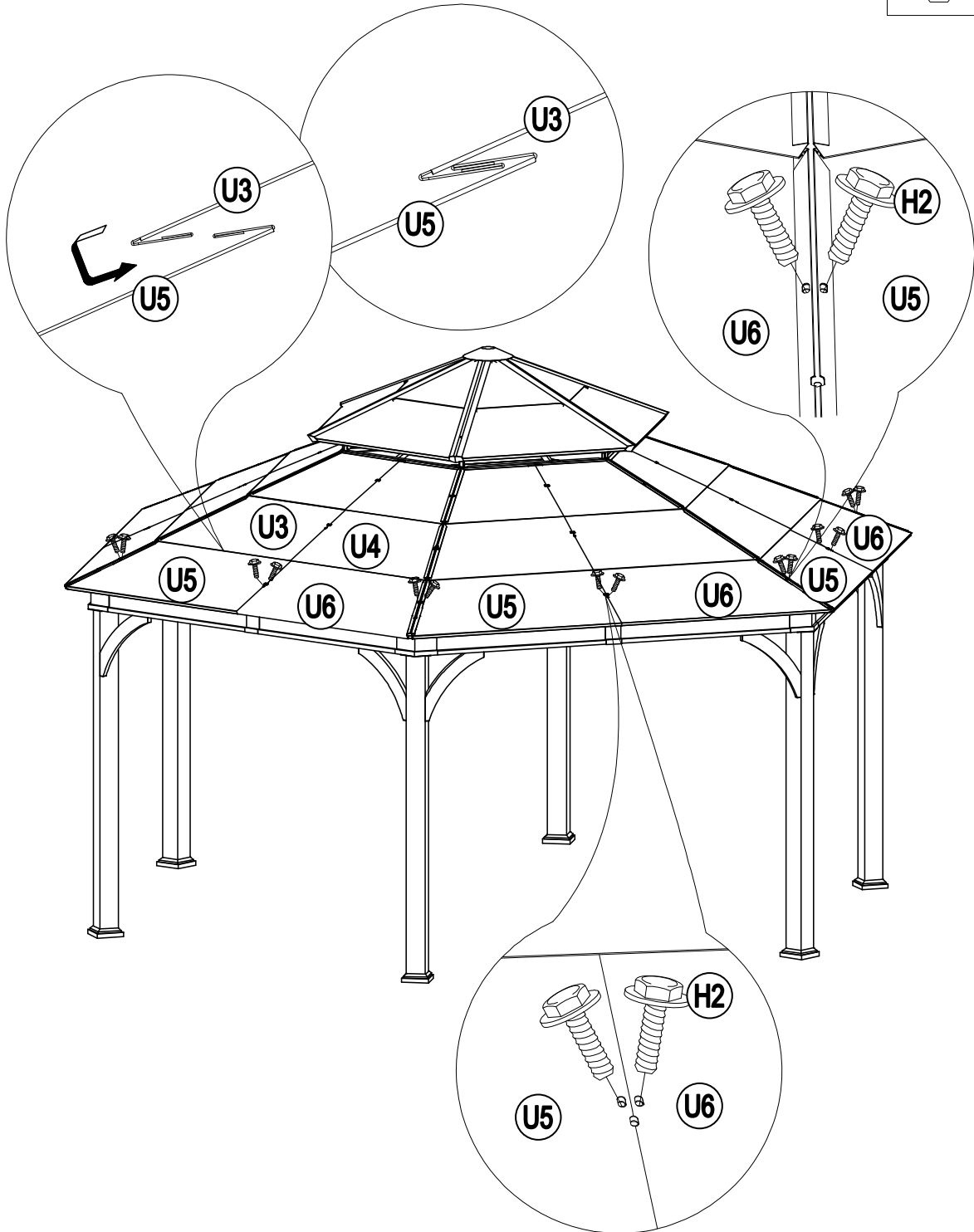
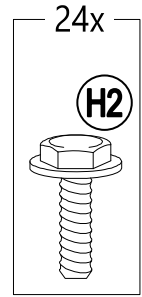
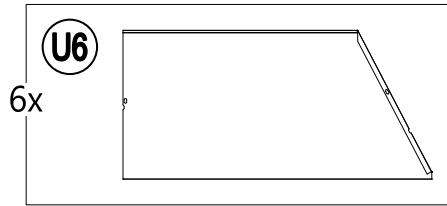
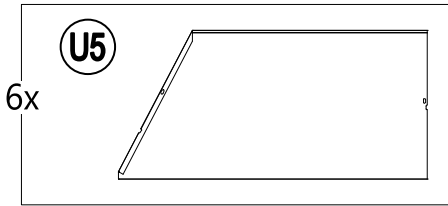

23

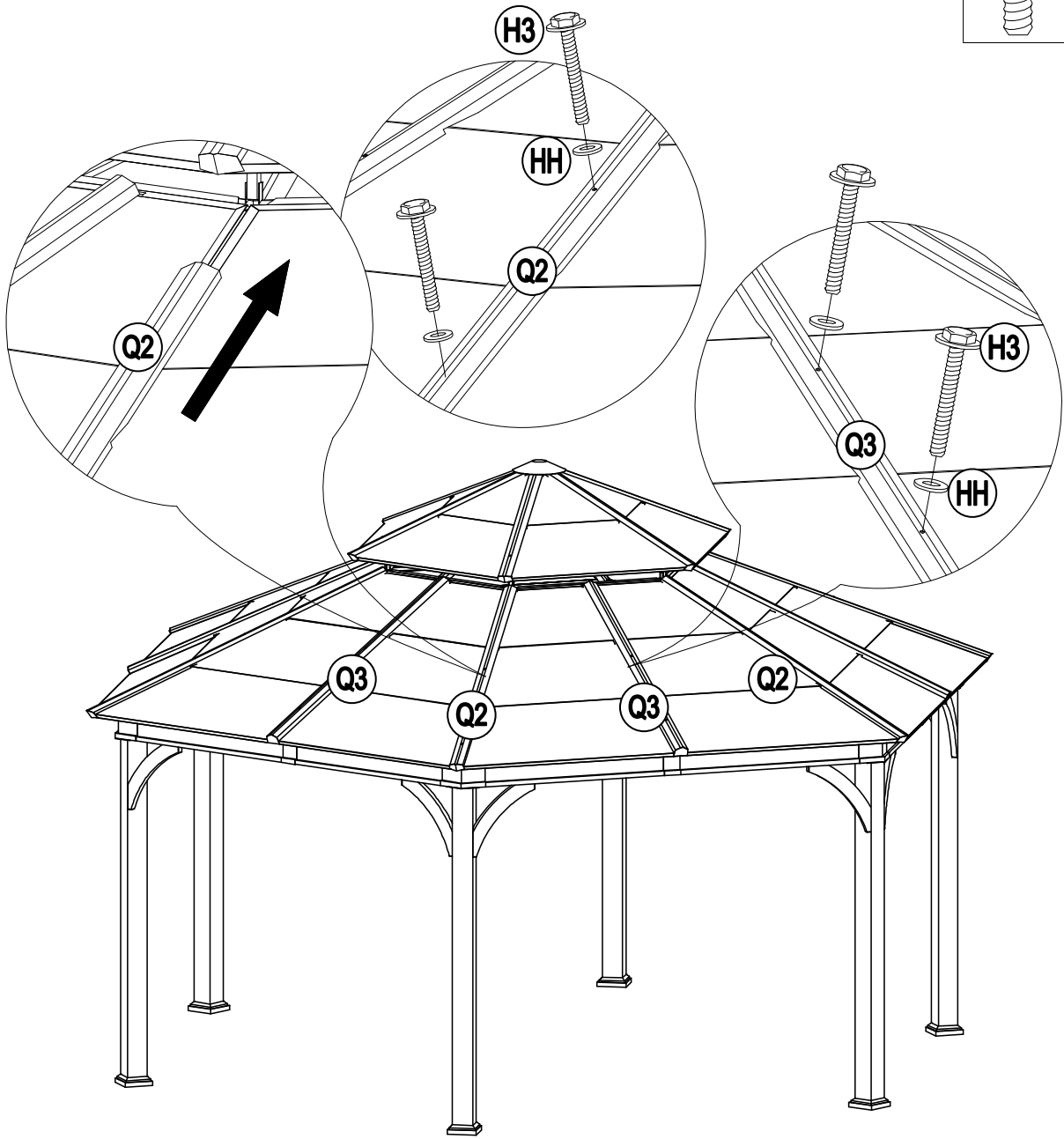
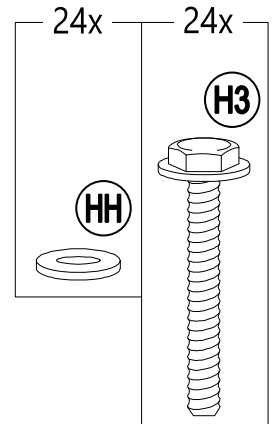
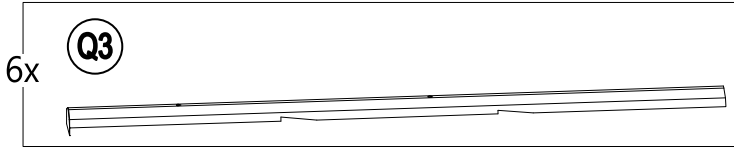
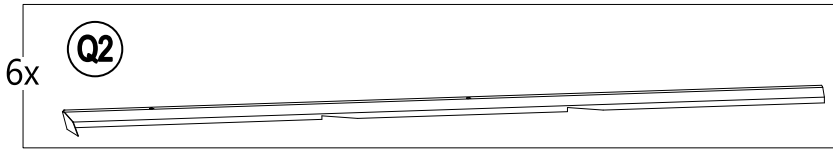

24

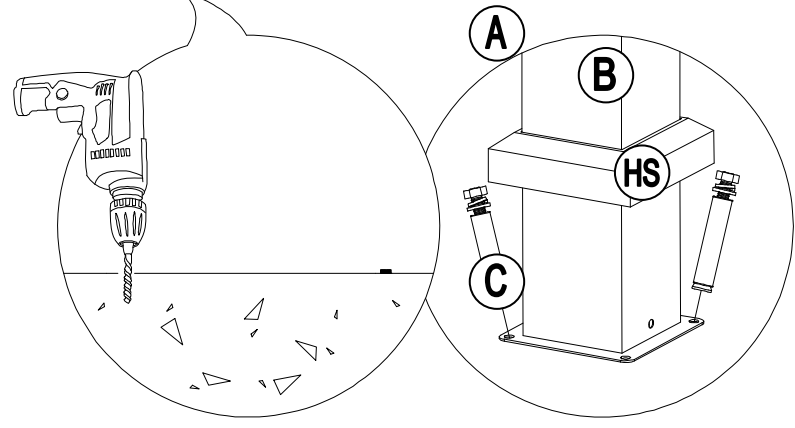
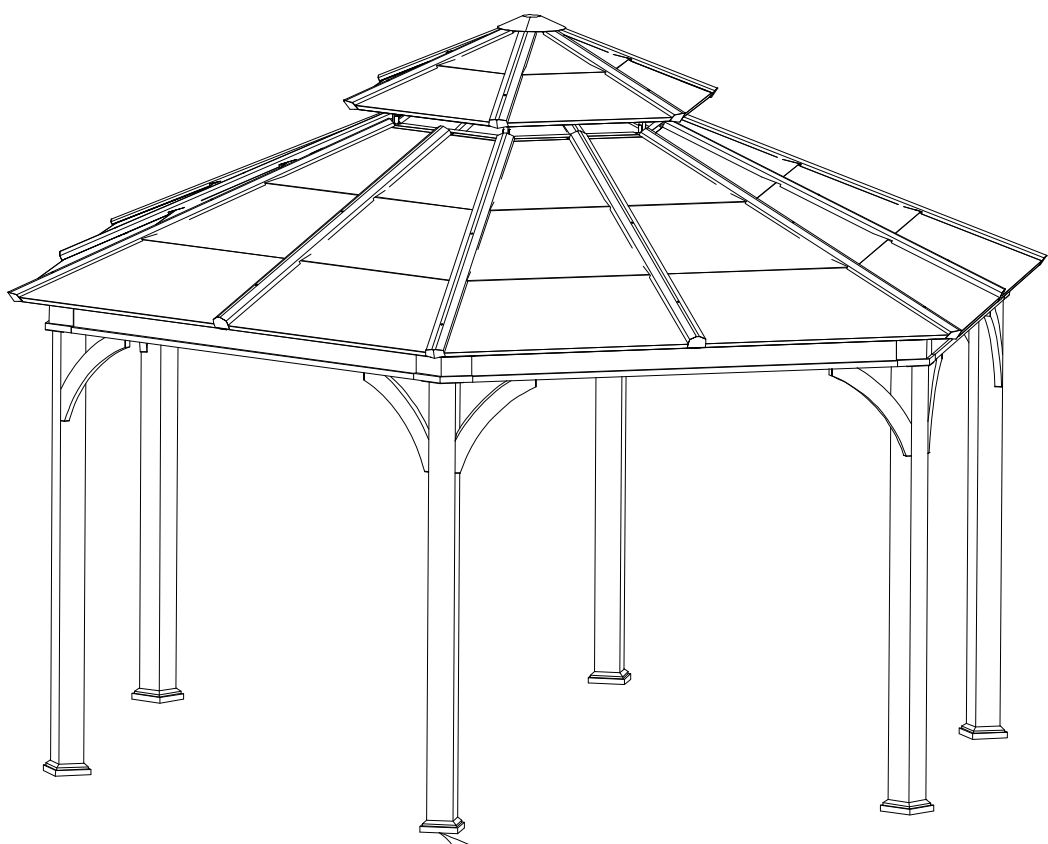
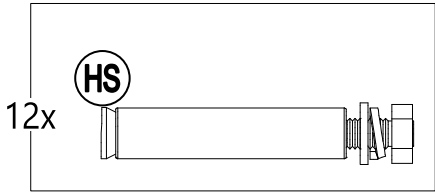

25

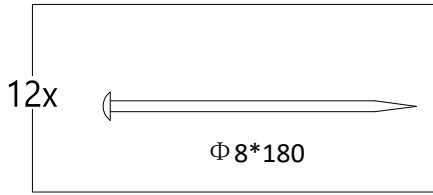

Not Included / Non Compris / No Incluidas

