

GAST/JUN-AIR

GAST MFG, INC. & JUN-AIR
 A Unit of IDEX Corporation
 Post Office Box 97
 Benton Harbor, Michigan 49022 U.S.A.
 Ph: 269/926-6171
 Fax: 269/925-8288

RTD#: RTD1061 REVISION: A

CUSTOMER: GAST STANDARD

PRODUCT SPECIFICATIONS

MODEL NO.	MOTOR	RPM	HP	kW	NET WT.	
					lbs.	kg
3HBB-19-M323A	24V DC	1615	.46	.34	19.5	8.84

SOUND LEVEL <75 dB(A)

NORMAL AMBIENT +5 to +40 °C

RELATIVE HUMIDITY 20 - 80%

ENVIRONMENT CLEAN AND DUST FREE

NOTES:

1. ALL DIMENSIONS ARE IN INCHES, AND ARE FOR REFERENCE ONLY.

PRODUCT PERFORMANCE:

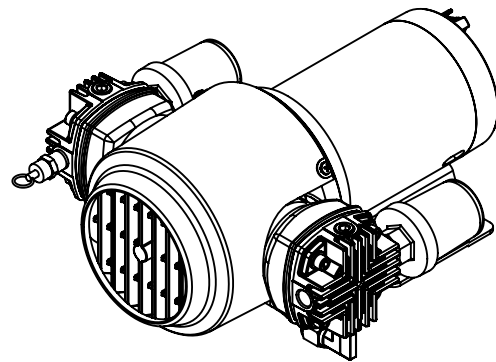
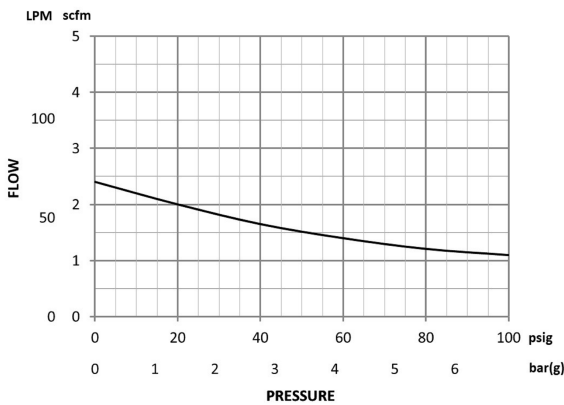

PRODUCT DIMENSIONS:

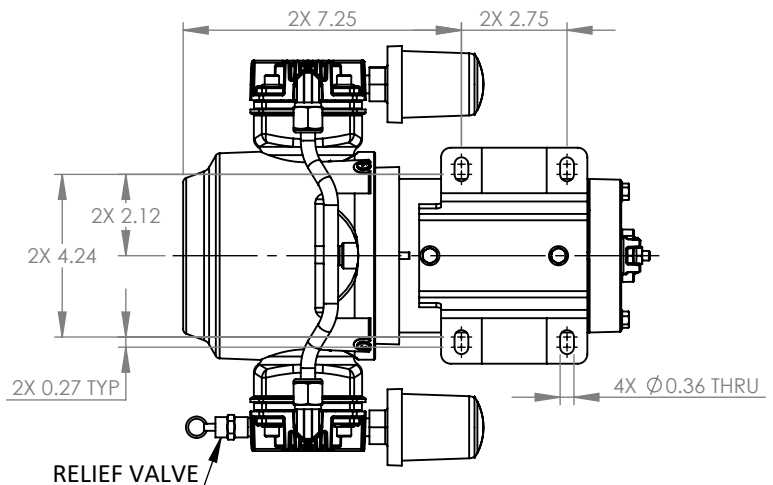
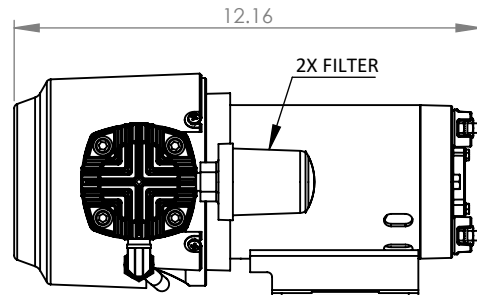
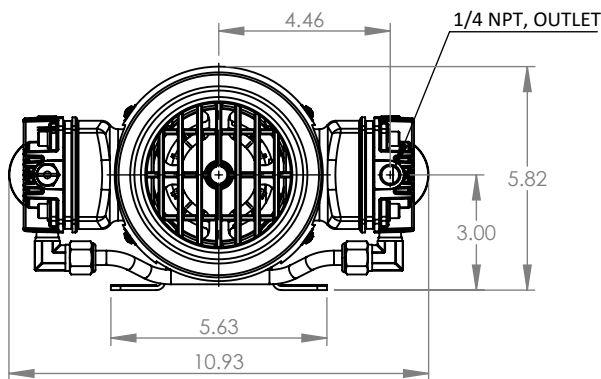

DOCUMENT CREATED DATE: 03/16/20