



# KT-LED10DL-4CA-9CSF-DIM

## 4" SURFACE MOUNT DISK LIGHT

REV1

### DESCRIPTION

4" Circular LED Residential Retrofit Disk Light

### APPLICATION

Ideal for residential, hospitality, retail, and other retrofit and new construction applications



### PRODUCT FEATURES

- Ideal for retrofit, new construction, and remodel applications
- Flush-mount offers clean, modern appearance
- Diffused lens reduces glare
- Powered by Keystone TRIAC dimming LED driver; 10–100% dimming
- Ambient operating temperature: –30°C/–22°F to 40°C/104°F
- Suitable for use in wet locations (covered ceiling mount only)
- Power factor: > 0.90
- FCC Part 15, Subpart B, Class B
- UL Listed

### PERFORMANCE SPECIFICATIONS

Catalog Number	Input Voltage	Wattage	CCT	Lumen Output	Efficacy	CRI	Beam Angle	Lifetime
KT-LED10DL-4CA-9CSF-DIM	120V	10W	2700K	850	85 lm/W	>90	110°	50,000 hrs
			3000K					
			3500K					
			4000K					
			5000K					

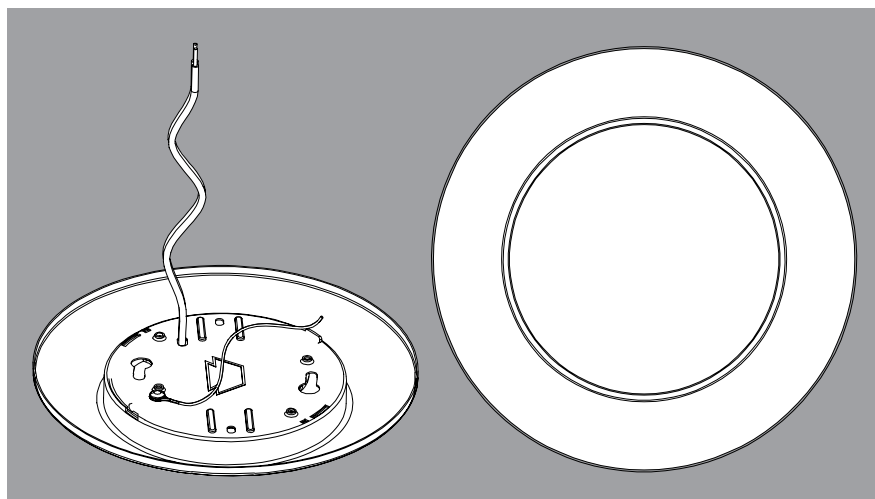

### GENERAL WIRING DIAGRAM

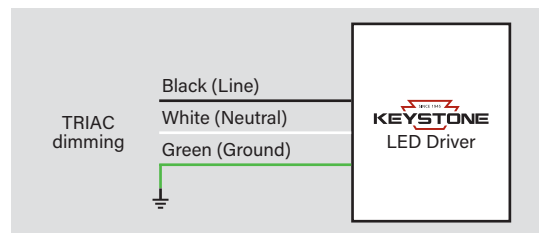



# KT-LED10DL-4CA-9CSF-DIM

## 4" SURFACE MOUNT DISK LIGHT

REV1

### PHOTOMETRICS SPECIFICATIONS

LUMINOUS INTENSITY DISTRIBUTION DIAGRAM

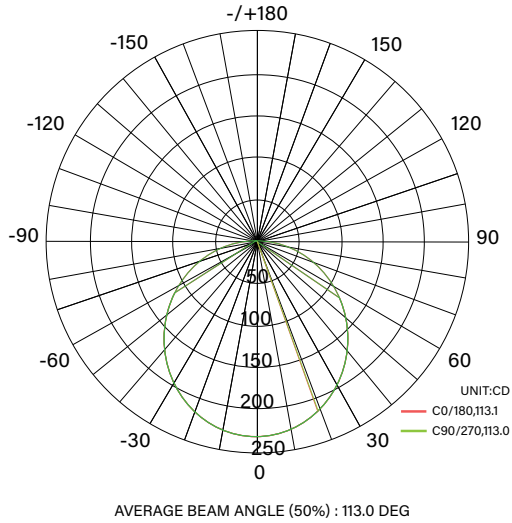

IsoLux Plots

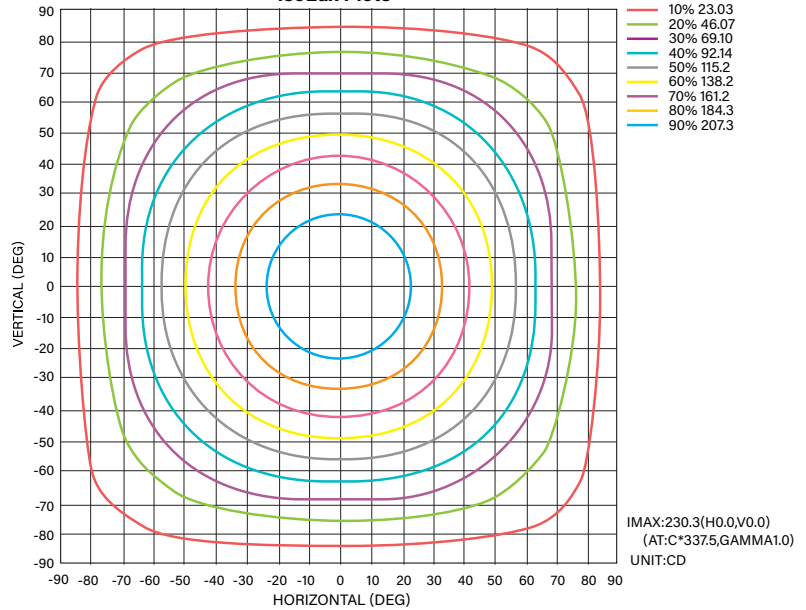

AVERAGE ILLUMINANCE EFFECTIVE FIGURE

FLUX OUT:486.4 LM

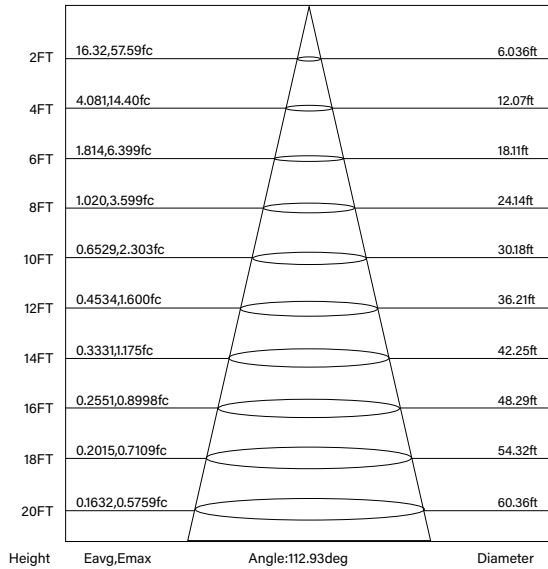

Note: The Curves indicate the illuminated area and the average illumination when the luminaire is at different distance.

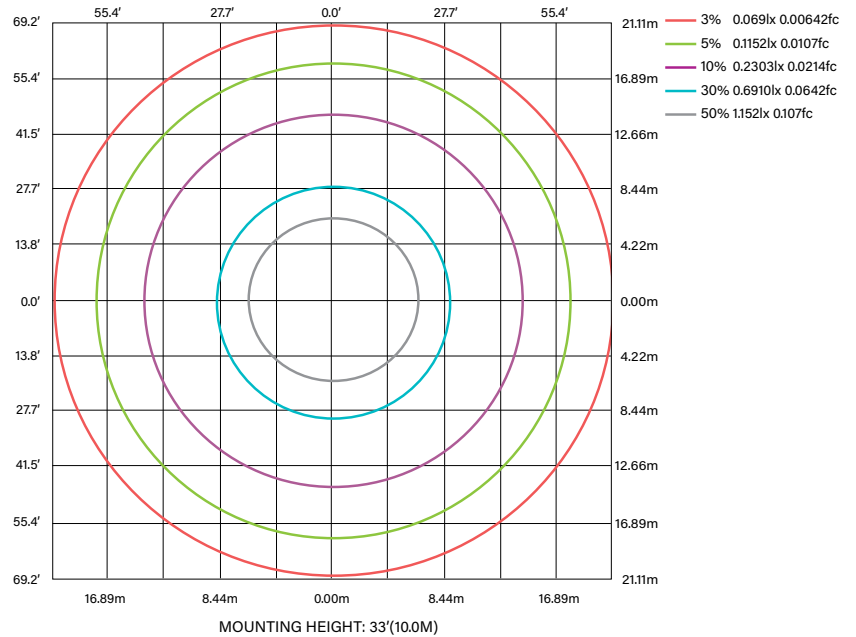

**KT-LED10DL-4CA-9CSF-DIM**  
4" SURFACE MOUNT DISK LIGHT

REV1

**PHYSICAL SPECIFICATIONS**

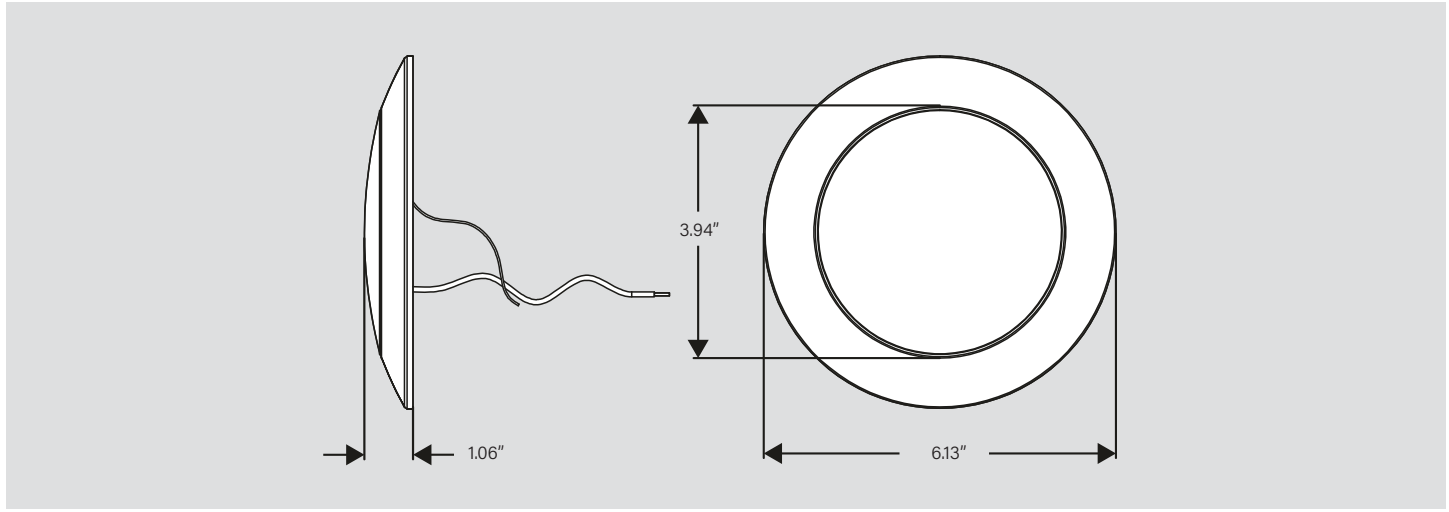

**INSTALLATION INSTRUCTIONS**

1. Shut off power.

2. Connect the luminaire to supply wires with the wire nuts (included).

3. Remove lens by turning counter clockwise to unlock.

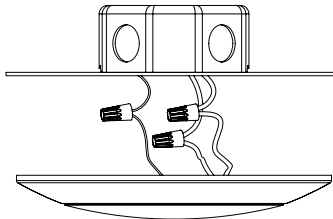

4. Select desired CCT

5. Safely place all wires into the junction box, mount luminaire to the junction box and screws through the keyhole slots. 4" luminaires are compatible with 2.75" junction boxes.

6. Replace lens and twist clockwise to lock.

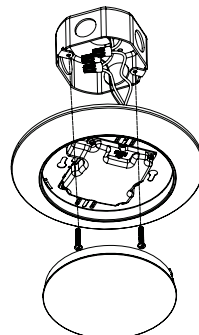
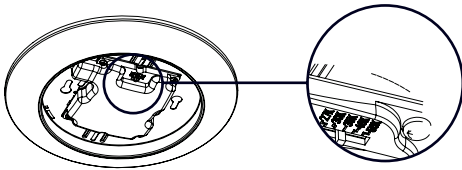

7. Restore power.



# KT-LED10DL-4CA-9CSF-DIM

## 4" SURFACE MOUNT DISK LIGHT

REV1

### ORDERING INFORMATION

Catalog Number	Pack Qty.	UPC	Easy Code
KT-LED10DL-4CA-9CSF-DIM	12	843654156910	XFR-31

### CATALOG NUMBER BREAKDOWN

# KT-LED10DL-4CA-9CSF-DIM

- 1
- 2
- 3
- 4
- 5
- 6
- 7
- 8
- 9
- 10
- 11

- 1 Keystone Technologies**
- 2 LED Technology**
- 3 Wattage**
- 4 Fixture Type**
  - DL Disk Light
- 5 Nominal Size**
  - 4 4" Nominal
- 6 Shape**
  - C Circular
- 7 Designation**
  - A Series A Design
- 10 Color Select Designation**
  - F 2700/3000/3500/4000/5000K
- 11 Dimming**
  - DIM TRIAC Dimmable