

HOUSEHOLD AIR PURIFICATION AND DISINFECTION MACHINE

Model: XDJ04



Thank you for purchasing our ozone & negative ion air purification series products!

We sincerely recommend that you read the operation manual carefully before using the product and retain this manual for reference.

1.WORKING PRINCIPLE

Ozone: The use of high voltage current at a certain frequency to create a high-voltage corona electric field, so that the oxygen molecules in the electric field or around the electric field electrochemical reaction, so as to create ozone.

Negative ions: By locally ionizing air molecules under high pressure, a large number of electrons and ions are formed, and these charged small particles of electrons and ions form negative ions.

2.FUNCTIONAL APPLICATION

Ozone (O₃) is an allotrope of oxygen (O₂), existing in gaseous form at room temperature and is colorless with a characteristic grassy odor at low concentrations. Ozone possesses a highly reactive chemical nature, boasting potent oxidizing capabilities. Upon encountering bacteria and harmful chemicals such as formaldehyde, benzene, and ammonia, it promptly initiates oxidation reactions, thereby functioning to sterilize, dehumidify, eliminate odors, and decompose harmful gases. Remarkably, ozone is unstable and reverts back to O₂ within hours, ensuring no pollution or residue is left behind. It stands as the sole substance globally recognized for directly disinfecting food and beverages!

1. Leveraging ozone's potent oxidizing properties effectively removes toxic substances emitted from adhesives, synthetic boards, and paints. It eradicates airborne bacteria and viruses, annihilates microorganisms thriving in carpets, combats cold-causing germs, prevents influenza outbreaks, and enhances indoor oxygen content.

2. Ozone excels in odor removal, given its superior capability to rapidly degrade odorous compounds and other organic or inorganic substances. Principal components of odors—amines (R₃N), hydrogen sulfide (H₂S), and methyl mercaptan (CH₂SH)—are swiftly broken down by ozone's intense oxidative power.

Negative ions are negatively charged oxygen molecules or other molecules, which are commonly found in the air, mountain springs, forests, and other environments in nature.

1. Improve air quality: Negative ions can adsorb and remove dust, bacteria, viruses, and harmful gases from the air, purify the air, and improve air quality.

2. Improve immunity: Regular exposure to negative ions can stimulate the function of the immune system, enhance the body's immune ability, and prevent colds and other diseases.

3. Relieve stress: Negative ions can promote blood circulation and metabolism, increase serotonin secretion in the body, and alleviate anxiety and stress.

4. Improving mood: Negative ions can stimulate dopamine secretion in the human body, making people feel relaxed and happy, and improving their mood.

Cautions:

1.It is forbidden to use in flammable, explosive, humid and other harsh environments.

2.It is forbidden to cover the air inlet and outlet, and the exhaust hole is strictly prohibited to block foreign objects.

3.When the ozone generator is working, please make sure that there are no people, pets and living things in the room. Do not enter the area until 30 minutes after the device has finished working.

4.The device must be powered off during maintenance.

5.Non-professionals are not allowed to disassemble the device without authorization.

6.If it is not used for a long time, the power supply should be cut off.

7.Regularly checking that the equipment is in good working order, and the power must be cut off immediately when an abnormality is found.

3.PRODUCT STRUCTURE

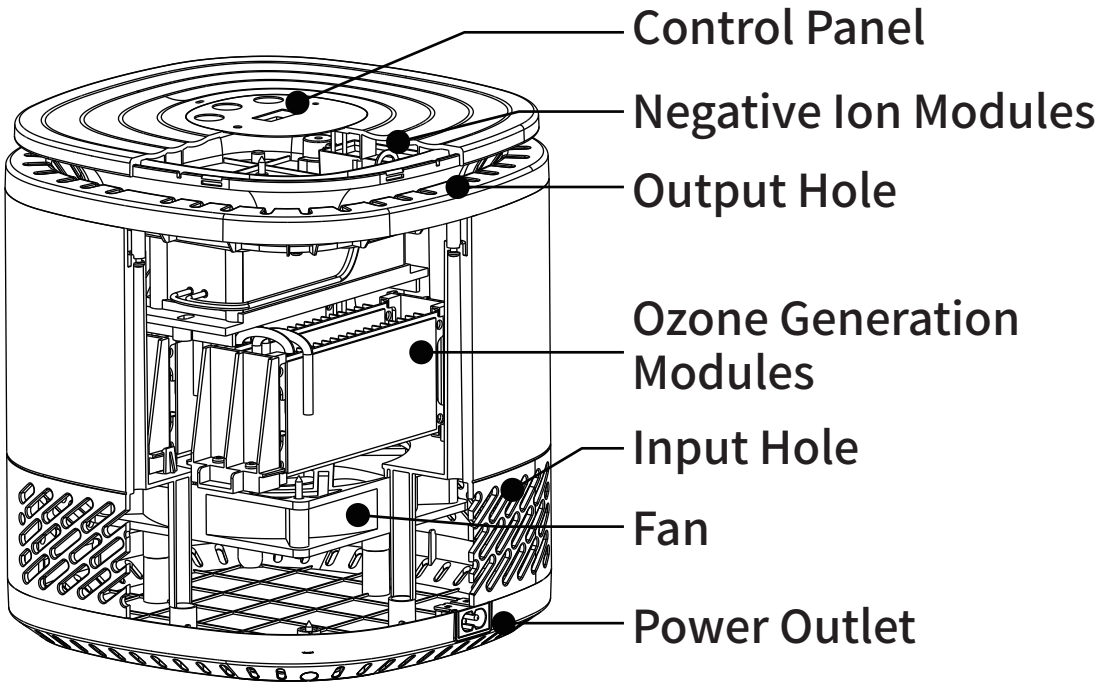





4.TECHNICAL PARAMETERS

Product Specification

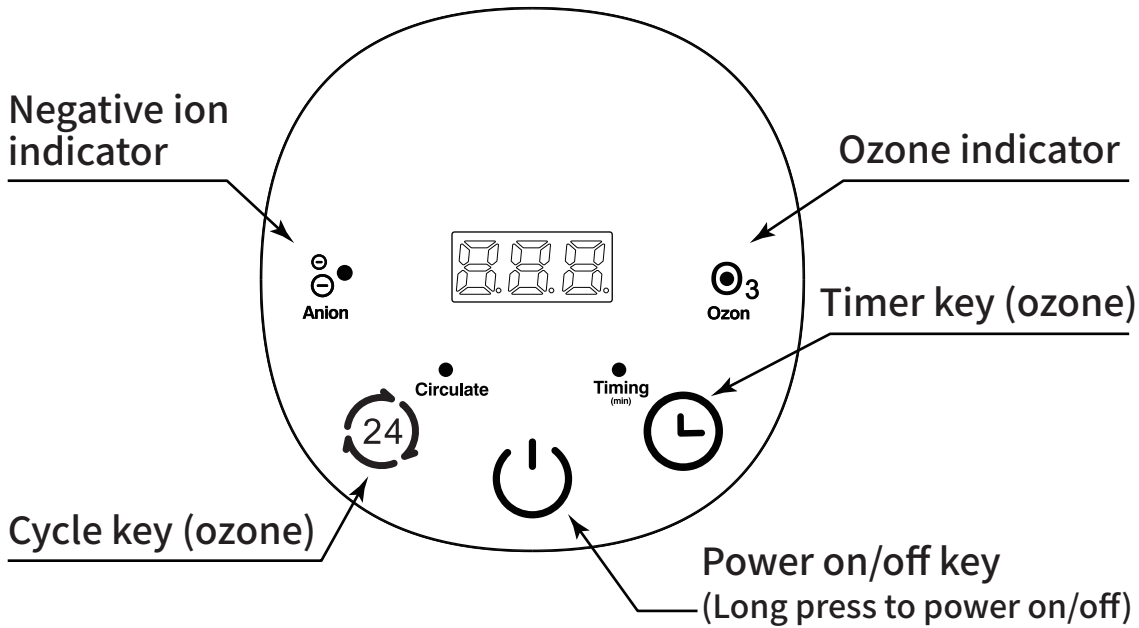
	5g/h	10g/h	16g/h	20g/h	24g/h	30g/h	40g/h
Ozone Output	5g/h	10g/h	16g/h	20g/h	24g/h	30g/h	40g/h
Rated Power	60W	60W	90W	90W	100W	100W	110W
Power supply	220V	220V	220V	220V	220V	220V	220V
Working Area	30m ²	60m ²	90m ²	120m ²	140m ²	200m ²	250m ²
Number of Modules	1 group	1 group	2 groups	2 groups	3 groups	3 groups	4 groups
Suggested Working Time	2h	2h	2h	2h	2h	2h	2h

5.USAGE METHOD

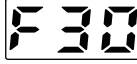

FUNCTION	HOW TO OPERATE	EXPLANATION
 Ozone cycle mode	Press one time: 4 gears (P30, P60, P90, exit cycle mode), means machine will working 30-60-90 minutes, cycle work once every 24 hours.	For example: Select 30 gear, screen display,  Ozone mode works for 30 minutes, stops for 23 hours and 30 minutes, and then runs for another 30 minutes..., continuously cycling in this way
 Ozone timer mode	Press one time: 6 gears (015, 030, 060, 090, 120, exit timer mode), means machine will working 15-30-60-90-120 minutes, automatically shut down after running.	For example: Select 060 gear, screen display,  the ozone function will automatically shut down after 60 minutes of running.
Negative ion function	Long press to turn on, the negative ion function is working by default. And continues to work at a rhythm of 'run for 30 mins, stop for 30 mins), until manually turn off. Screen display 	Negative ion only work in one state.