

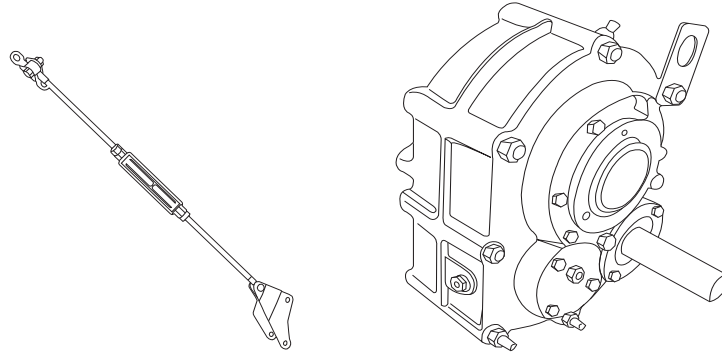

# SHAFT MOUNT SPEED REDUCER MODEL # SMR5-15/1 & SMR5-25/1



**SPECIFICATIONS - Exact Dimensional Drop-In For All Major Makes**

Box Size	Ratio	Output Bore
5	15:1 & 25:1	2-15/16" Max.

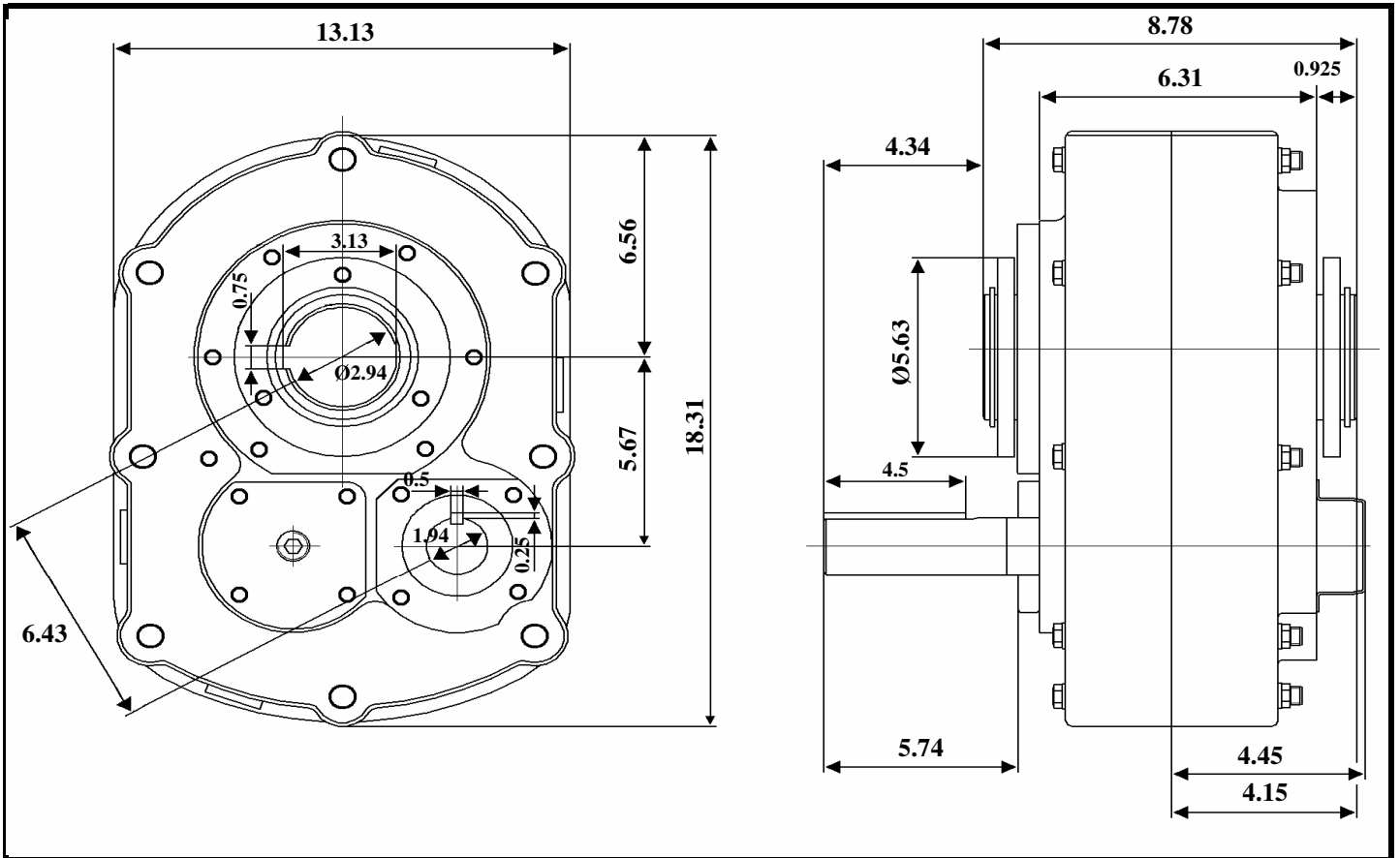

**REVISED 08/18/08**