



Safety switch with separate actuator ST 14 2Ö - 5m Article no.: 1045563 (old article no.: 14553705)

Product features

- Thermoplastic enclosure
- With pre-wired cable

Notes

- The actuator is not included in the delivery of the switches.

Dimensions

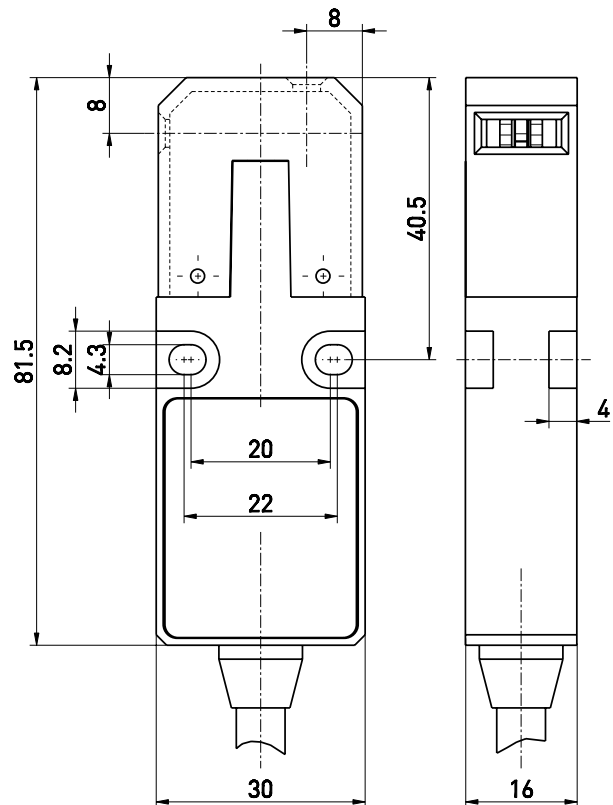

Technical data

Applied standards

EN 60947-5-1, EN ISO 13849-1, EN ISO 14119

Enclosure

thermoplastic, glass-fibre reinforced, shockproof, self-extinguishing UL 94 V-0

Switch type

type 2

Coding level

low coding

Tightening torque

enclosure mounting screws: max. 1.5 Nm

Degree of protection

IP67 (IEC/EN 60529)

B_{10d} (10 % load)

2 million

T_M

max. 20 years

Contact material

silver

Switching system

slow action, positive break NC contacts ⊖

Switching elements

2 NC contacts, type Zb

Connection

cable 4 x AWG 20 UL 2464

Cable diameter

5.4 mm ±3%

Cable cross-section

4 x 0.56 mm²

Rated impulse withstand voltage U_{imp}

4 kV

Rated insulation voltage U_i

250 V

Conventional thermal current I_{the}

6 A

Rated operating current/voltage I_e/U_e

6 A/250 VAC; 0.25 A/230 VDC; 4 A/24 VDC

Errors and omissions excepted.



Safety switch with separate actuator ST 14 2Ö - 5m

Article no.: 1045563 (old article no.: 14553705)

Technical data (contd.)

Utilisation category

AC-15; DC-13

Short-circuit protection

6 A gG/gN fuse

Safety class

II

Positive break travel

8 mm

Ambient temperature

-20 °C ... +75 °C

Mechanical life

> 1 million operations

Approvals



Cable length

5 m

Weight

290 g

Contact diagram

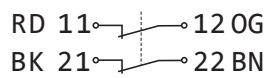

Switching diagram

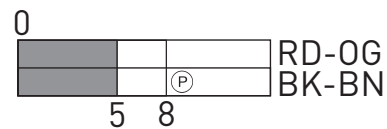

Ⓟ Positive break travel/angle

Note

Inserted position of actuator = 0 in switching diagram.
The actuator is not included with the switches.