

L-F401:封面250g铜版纸,内页128g铜版纸,全书24P、成品尺寸96\*135mm、骑马订、封面底面覆亚膜、彩印

## User Manual

Model No.: L-F401

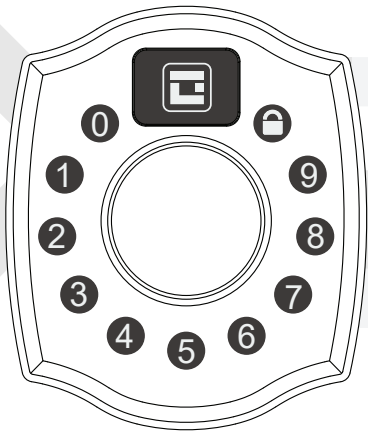

**IMPORTANT:** Read the instructions carefully before operating the device and keep them for future reference.

<b>Features</b>	<b>2</b>
<b>Operating Instructions</b>	<b>3</b>
<b>Troubleshooting</b>	<b>19</b>
<b>Specifications</b>	<b>21</b>

## Welcome

GeekSmart bids you welcome to a world of smart home devices, smart locks, and smart surveillance. We at GeekSmart strive to explore and develop the smart home industry for the good of all.

We use cutting-edge technologies to develop products fit and ready for the market.

Please visit our website **[www.geektechnology.com](http://www.geektechnology.com)**

Before installing, please scan the QR codes to watch our easy step-by-step installation video.

If you have questions regarding the installation process please contact us by mail **[customer care@geektechnology.com](mailto:customer care@geektechnology.com)** or by phone **1-844-801-8880/(862)352-0406**.







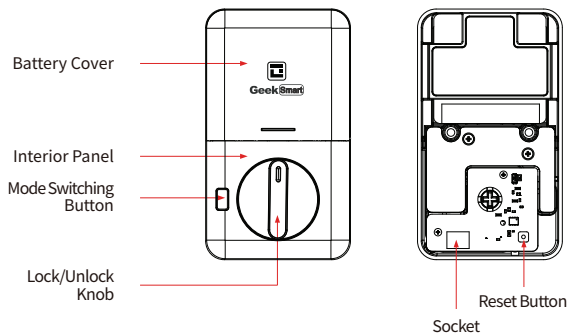
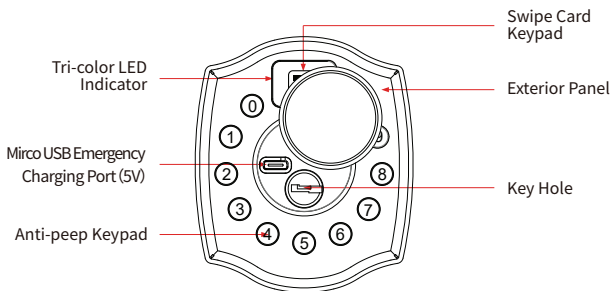





Scan the QR code for more assistance and support

# Product Description



## Included In The Box

<p>A</p>  <p>Exterior panel 1PC</p>	<p>B</p>  <p>Interior panel 1PC</p>	<p>C</p>  <p>Interior mounting plate 1PC</p>	<p>D</p>  <p>Deadbolt 1PC</p>	<p>E</p>  <p>Strike parts 1PC</p>
<p>F</p>  <p>Screws A 4PCS</p>	<p>G</p>  <p>Screws B 3PCS</p>	<p>H</p>  <p>Screws C 3PC</p>	<p>I</p>  <p>IC Cards 2PCS</p>	<p>J</p>  <p>Keys 2PCS</p>

## Assembly Diagram

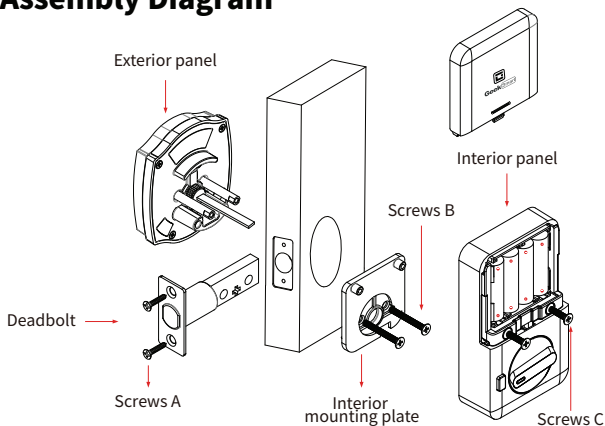

## Check The Door's Dimensions

Step 1: Measure to confirm that the door is between  $1\frac{1}{8}"$ ~ $2\frac{1}{8}"$  (35mm~54mm) thick.

Step 2: Measure to confirm that the hole in the door is  $2\frac{1}{8}"$  (54mm).

Step 3: Measure to confirm that the backset is either  $2\frac{3}{8}"$ ~ $2\frac{3}{4}"$  (60-70mm).

Step 4: Measure to confirm that the hole in the door edge is  $1"$  (25mm).

NOTE: If you have a new door, please drill the holes according to Drill Template.

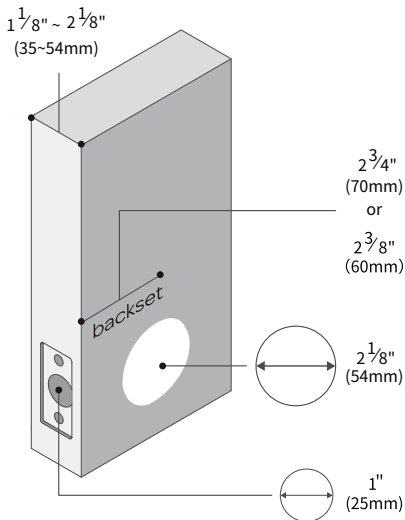

## Installing latch and strike plate

1. Install latch into the door, make sure latch fits inside the door opening.
2. Install the strike into the door frame, make sure the latch can go into the strike smoothly.

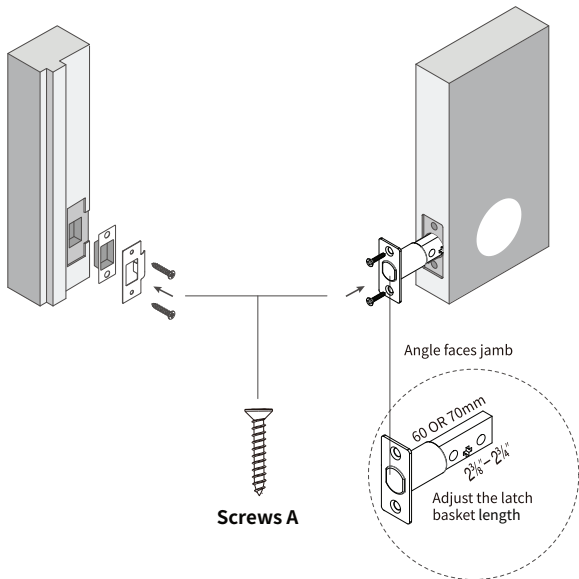

## Installation Exterior Panel

**NOTE:** The thumb latch should be in a vertical position.

**DO NOT CLOSE** the door until the door lock is fully installed and the batteries are installed.

**DO NOT CLOSE** the door until the administrator and the necessary code /card to open the door are set up.

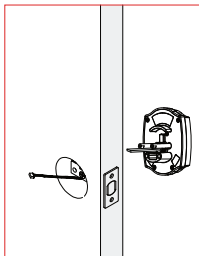

### Step 1:

If the deadbolt latch is extended, use a flat-head screwdriver to retract it. From the outside of your door, align the spindle horizontally through the latch assembly and push the exterior panel in until it is flush against the door.

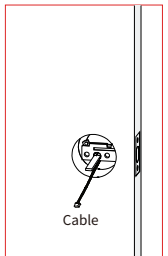

Cable

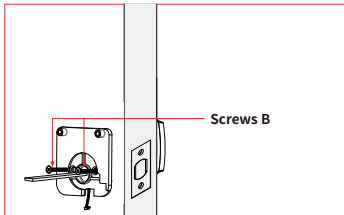

Screws B

### Step 2:

Install the interior mounting plate from the inside of your door. Route the cable below the bolt and through the hole on the underside of the mounting plate. Use the provided **screws B** to secure the mounting plate to the exterior panel.

## Installing Interior Panel For Right Hinge

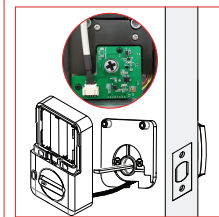
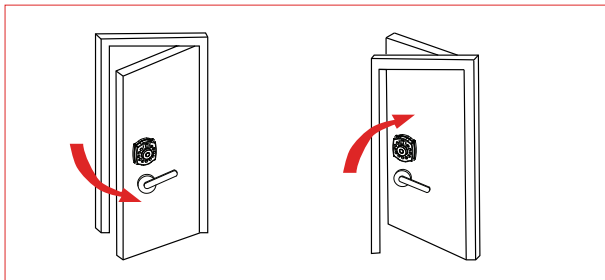

### Step 3:

For right-hinged doors, the knob should be kept in a horizontal position. Insert the connector of the cable to the socket on the interior panel. Press the connector in firmly until it is completely seated. Push the excess wire into the door, align the back panel until it is flush against the door.

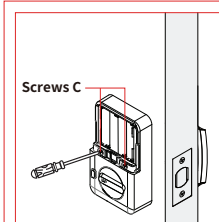

### Step 4:

Attach interior panel to interior mounting plate and tighten 2 screws.

Note: Turn the knob of the interior panel to check if the deadbolt protrudes and retracts smoothly. Shut door to check if deadbolt protrudes and retracts in strike plate smoothly. If not, please review your installation or contact support.

## Installing Interior Panel For Left Hinge

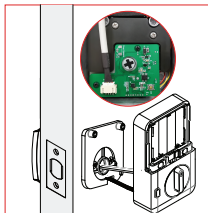
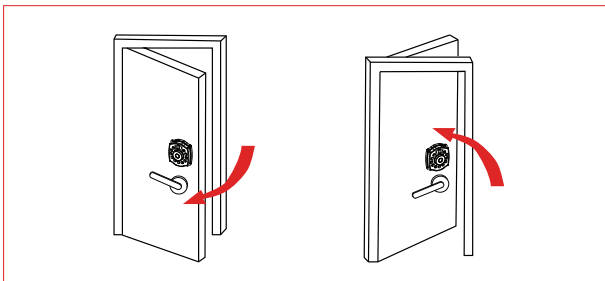

### Step 3:

For left-hinged doors, the knob should be kept in a vertical position. Insert the connector of the cable to the socket on the interior panel. Press the connector in firmly until it is completely seated. Push the excess wire into the door, align the back panel until it is flush against the door.

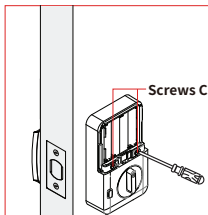

### Step 4:

Attach the interior panel to the interior mounting plate and tighten 2 screws.

**Note:** Turn the knob of the interior panel to check if the deadbolt protrudes and retracts smoothly. Shut door to check if deadbolt protrudes and retracts in strike plate smoothly. If not, please review your installation or contact support.

## Installing Batteries

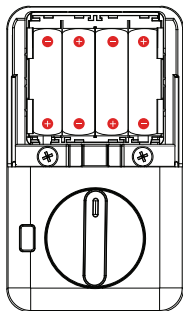

Insert 4\*AA batteries according to positive and negative polarity.

**Do not use rechargeable batteries.**

# App Operation Guide

## 1. App Download Instructions

- (1) Scan the QR code to the right, you can use Android and iOS to download the APP.
- (2) Android version software can be downloaded in the Google Play store. Search "GeekSmart".
- (3) iOS version of the software can be downloaded in the iPhone App Store. Search "GeekSmart".



## 1. Adding new Door Lock by app (Note: Keep your phone close by the door during this process).

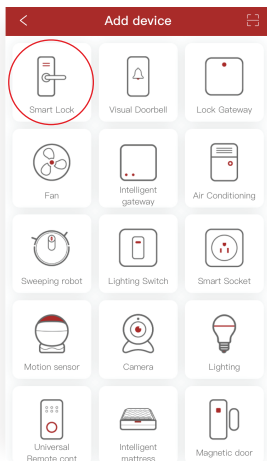
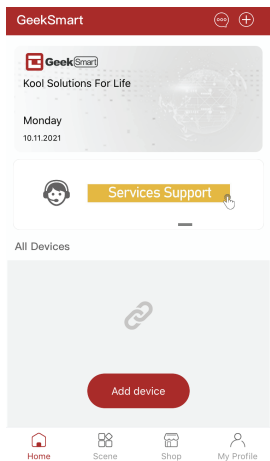

① Tap the add button “+”.

② Select the smart lock.

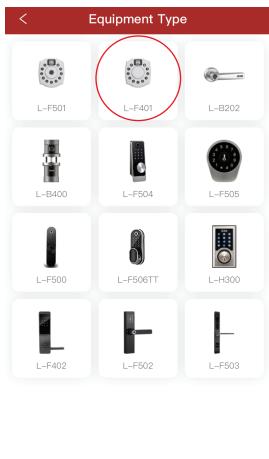

③ Select lock L-F401.

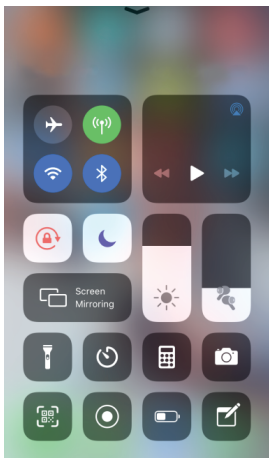

④ Turn on Bluetooth on your phone.

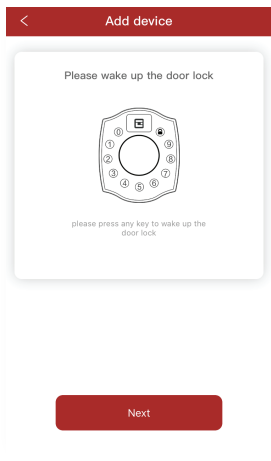

⑤ Activate the lock by pressing a key on the keypad.

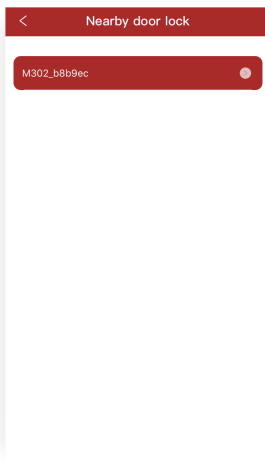

⑥ Select your lock.

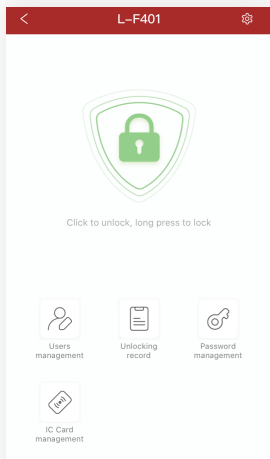

⑦ Door lock added successfully.

When door lock has been added successfully, please tap the "  " button in the upper right corner to check your new administrator password.

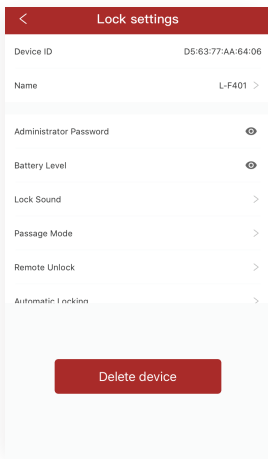

⑧ Check administrator password.

## 2. Access code management

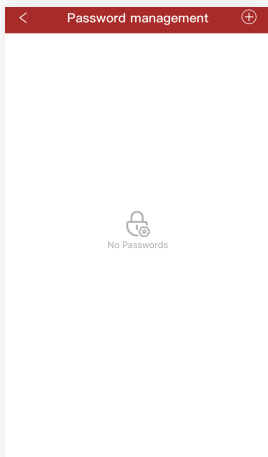

- ① Please tap "+" in the right upper corner to add new user.

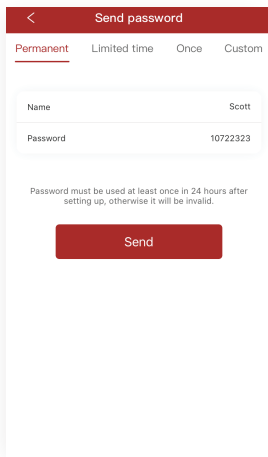

- ② Administrator can manage codes.

### 3. Users management

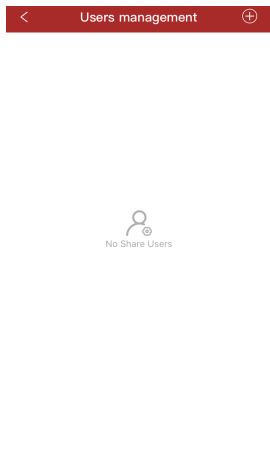

- ① Please tap "+" in the right upper corner to add new user.

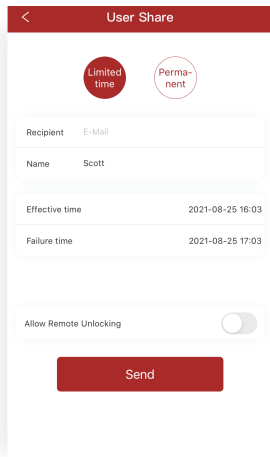

- ② Administrator can manage all users.

Admins can send Ekeys to emails. The receiver needs to download the GeekSmart app and log in to use the Ekey.

Administrators can manage all users, delete Limited time user or Permanent user and view unlock records.

Access code management refers to the digital code combination of the door lock. You can send codes to others to grant access.

**Once:** To be used one time only. This code can be copied and sent by email.

**Permanent:** to be used permanently, with no time limit.

**Limited time:** limited time access.

**Customized:** you can customize your permanent code.

The administrator can manage all the codes that were sent , deleting codes or sending new ones, modifying validity period , disable codes , and view unlock history.

#### 4. Add bluetooth administrator

Make sure the door lock administrator is not added. With the door backlight off , the user touches the numeric keypad to wake up the door lock. After hearing the voice prompt "Please add Bluetooth administrator" , open the mobile phone bluetooth and begin the door lock addition process on the app to obtain Bluetooth administrator privileges. After the addition is successful , you will hear the voice prompt "Administrator has been successfully added."

#### 5. Delete bluetooth administrator through the app

The user must be running the app near the door lock. Tap the Setting button in the upper right corner of the added door lock on the homepage. After entering the door lock setting page, click the " restore factory settings" or " delete device" to remove Bluetooth administrator privileges.

#### 6. IC Cards management (RFID-CARD management)

Add IC Card: please enter IC card name, tap "next", then please place the IC card against the card reader sensor on the smart lock.

Clear IC card: tap "delete IC card" button.

## Settings By Keypad

Though we recommend using the app, you can chose to use the keypad to set up lock users etc.

### 1. Changing Admin Passcode (Default “123456”)

🔑 → 12 → 🔑 → Original Passcode → 🔑 → New Passcode → 🔑 → New Passcode (again) → 🔑

If successful, lock should prompt “Input Successful”.

### 2. Add User Passcode / IC-Card

A. Add user passcode:

🔑 → 85 → 🔑 → Admin Passcode → 🔑 → New User Passcode → 🔑 → New User Passcode (again) → 🔑

B. Add User IC Card:

🔑 → 85 → 🔑 → Admin Passcode → 🔑 → SCAN CARD

### 3. Change User Passcode

🔑 → 10 → 🔑 → Original Passcode → 🔑 → New Passcode → 🔑 → New Passcode (again) → 🔑

### 4. Delete All User IC-Cards

🔑 → 69 → 🔑 → Admin Passcode → 🔑

### 5. Delete All User Passcodes

🔑 → 71 → 🔑 → Admin Passcode → 🔑

Note: except admin user, ALL user passcodes, including app users' passcodes, will be deleted.

### 6. Set The Lock For “Right Hinge” Or “Left Hinge”

🔑 → 46 → 🔑 → Admin Passcode → 🔑

A. 1 → 🔑 → for right hinge.

B. 2 → 🔑 → for left hinge.

# Troubleshooting

## **Q: How can I reset the lock?**

A: Please note all data will be erased if you reset F401 to factory default.

A: If you are using GeekSmart App as manager, please tap “restore factory settings” or “Delete device”.

A: Remove then reinstall the batteries, press and hold the "Mode Switching Button" until you hear the voice "Enter the initialization password", then enter "000+#" on the keypad.

## **Q: How to active secure lock mode?**

A: Press and hold Mode Switching Button to activate or deactivate the secure lock mode.

A: When secure lock mode is activated, only the administrator ( it also requires administrator password) can unlock the lock.

## **Q: What is the difference between administrator, user?**

A: Administrator is the person who owns L-F401 and registers in GeekSmart App originally. Administrator has all lock management privileges.

A: User can always unlock via code or App.

## **Q: Does F401 work with third-party accessories such as a deadbolt?**

A: It is recommended to use the original accessories for best performance and stability.

## **Q: How can I control F401 remotely?**

A: L-F401 is a bluetooth enabled smart lock. You can pair the optional GeekSmart gateway with L-F401 to control it remotely via GeekSmart App.

## **Q: How can I adjust the lock orientation of L-F401?**

A: The lock orientation must be adjusted after installation to ensure L-F401 works properly.

A: Adjust the lock orientation directly on the lock. Go to page 7 or page 8 for details.

A: Adjust the lock orientation via the GeekSmart App.

**Q: What notification will I receive when the battery is low?**

A: In case of low battery power, there will be a voice reminder when unlocking, and the remaining battery power can be viewed in the APP door lock setting interface.

A: The remaining power can provide about 50 times to unlock.  
Please replace battery in time.

**Q: How can I unlock L-F401 if battery runs out?**

A: Use the key to unlock.

**Important Note:**

Please keep at least one key in secure location elsewhere as an extra precaution. Connect a 5V power bank to activate the lock temporarily.

**Q: How do I activate the lock after entering an incorrect code or card too many times?**

A: If the lock receives too many invalid unlock attempts, it will be temporarily disabled for security reasons. In this case, you can only unlock L-F401 with the GeekSmart App.

# Specifications

## TECHNICAL PARAMETERS

1	Power supply	4.5~6.5V (4 pcs AA alkaline batteries)	
2	Support phone system	Android 4.3/IOS 7.0 or above	
3	Alarm voltage	4.8V $\pm$ 0.2V	
4	Static current	$\leq 75\mu\text{A}$	
5	Dynamic current	$\leq 350\text{mA}$	
6	Operating temperature	Exterior panel -25~70°C	
		Interior panel -10~50°C	
7	Operating humidity	20 ~ 93 %RH	
8	Opening delay	around 1.5 seconds	
9	Mobile phone app	GeekSmart	
10	RFID-Card (Mifare1) Capacity	1000pcs	
11	Access code capacity	Code sent by the app	No limitation
		Custom code	250 pcs





**GeekSmart**<sup>®</sup>

*Bring The Future Home*

Geektechnology Ltd.  
120 Route 46 West,  
Parsippany, NJ 07054.  
Toll Free  
1-844-801-8880  
(862)352-0406

